

SHARP

Projector

X171Q-B/X171Q-W
X141Q-B/X141Q-W

User's Manual

Model No.

XP-X171Q-B/XP-X171Q-W/XP-X141Q-B/XP-X141Q-W

Table of Contents

Introduction	ii
Important Information	iii
1. Check the product overview, supplied items and part names	1
1-1. Introduction to the Projector	1
1-2. What's in the Box?	3
1-3. Part Names of the Projector	4
1-4. Part Names of the Remote Control	11
2. Projecting an Image (Basic Operation)	17
2-1. Flow of Projecting an Image	17
2-2. Connecting Your Computer/Connecting the Power Cord	18
2-3. Turning on the Projector	20
2-4. Selecting a Source	23
2-5. Adjusting the Picture Size and Position	24
2-6. Turning off the Projector	31
2-7. After Use	32
3. Appendix	33
3-1. Specifications	33
3-2. Troubleshooting	36
3-3. Mounting a lens (sold separately)	42

Introduction

Thank you for purchasing the projector.

This projector can be connected to computers, video devices, etc. to project images sharply onto a screen.

Please read this manual carefully before using your projector.

Read this manual if you have any doubts about operation or if you believe the projector may be faulty.

The Installation Manual provides detailed instructions on installation, adjustments, maintenance, etc., is posted on our website.

https://www.sharp-nec-displays.com/dl/en/pj_manual/lineup.html

NOTES

- (1) The contents of this manual may not be reprinted in part or whole without permission.
- (2) The contents of this manual are subject to change without notice.
- (3) Great care has been taken in the preparation of this manual; however, should you notice any questionable points, errors or omissions, please contact us.
- (4) The image shown in this manual is indicative only. If there is inconsistency between the image and the actual product, the actual product shall govern.
- (5) Notwithstanding article (3) and (4), we will not be responsible for any claims on loss of profit or other matters deemed to result from using this device.
- (6) This manual is commonly provided to all regions so they may contain descriptions that are pertinent for other countries.

Important Information

Supplier's Declaration of Conformity

SHARP PROJECTOR, XP-X171Q-B/XP-X171Q-W/XP-X141Q-B/XP-X141Q-W

This device complies with Part 15 of the FCC Rules. Operation is subject to the following two conditions: (1) This device may not cause harmful interference, and (2) this device must accept any interference received, including interference that may cause undesired operation.

Responsible Party: SHARP ELECTRONICS CORPORATION
100 Paragon Drive, Montvale, NJ 07645
TEL: (630) 467-3000 www.sharpneccdisplays.us

WARNING:

FCC Regulations state that any unauthorized changes or modifications to this equipment not expressly approved by the manufacturer could void the user's authority to operate this equipment.

NOTE:

This equipment has been tested and found to comply with the limits for a Class A digital device, pursuant to Part 15 of the FCC Rules. These limits are designed to provide reasonable protection against harmful interference when the equipment is operated in a commercial environment. This equipment generates, uses, and can radiate radio frequency energy and, if not installed and used in accordance with the instruction manual, may cause harmful interference to radio communications.

Operation of this equipment in a residential area is likely to cause harmful interference in which case the user will be required to correct the interference at his own expense.

U.S.A. ONLY

Cable information

Use shielded cables or cables attached ferrite cores so as not to interfere with radio and television reception.

Notice Concerning Electromagnetic Interference (EMI) (For other regions)

WARNING:

Operation of this equipment in a residential environment could cause radio interference.

(For Customers in U.K.)

IMPORTANT

- The wires in this mains lead are coloured in accordance with the following code:

GREEN-AND-YELLOW:	“Earth”
BLUE:	“Neutral”
BROWN:	“Live”

- As the colours of the wires in the mains lead of this apparatus may not correspond with the coloured markings identifying the terminals in your plug proceed as follows:
- The wire which is coloured GREEN-AND-YELLOW must be connected to the terminal in the plug which is marked by the letter **E** or by the safety earth symbol \perp or coloured green or green-and-yellow.
- The wire which is coloured BLUE must be connected to the terminal which is marked with the letter **N** or coloured black.
- The wire which is coloured BROWN must be connected to the terminal which is marked with the letter **L** or coloured red.
- Ensure that your equipment is connected correctly. If you are in any doubt consult a qualified electrician.

“WARNING: THIS APPARATUS MUST BE EARTHED.”



Information on the Disposal of this Equipment and its Batteries

IF YOU WISH TO DISPOSE OF THIS EQUIPMENT OR ITS BATTERIES, DO NOT USE THE ORDINARY WASTE BIN, AND DO NOT PUT THEM INTO A FIREPLACE!

Used electrical and electronic equipment and batteries should always be collected and treated SEPARATELY in accordance with local law.

Separate collection promotes an environment-friendly treatment, recycling of materials, and minimizing final disposal of waste. IMPROPER DISPOSAL can be harmful to human health and the environment due to certain substances! Take USED EQUIPMENT to a local, usually municipal, collection facility, where available.

Remove USED BATTERIES from equipment, and take them to a battery collection facility; usually a place where new batteries are sold.

If in doubt about disposal, contact your local authorities or dealer and ask for the correct method of disposal.

ONLY FOR USERS IN THE EUROPEAN UNION, AND SOME OTHER COUNTRIES; FOR INSTANCE NORWAY AND SWITZERLAND: Your participation in separate collection is requested by law.

The symbol shown above appears on electrical and electronic equipment and batteries (or the packaging) to remind users of this. If 'Hg' or 'Pb' appears below the symbol, this means that the battery contains traces of mercury (Hg) or lead (Pb), respectively.

Users from PRIVATE HOUSEHOLDS are requested to use existing return facilities for used equipment and batteries.

Batteries are collected at points of sale. Return is free of charge.

If the equipment has been used for BUSINESS PURPOSES, please contact your dealer who will inform you about take-back. You might be charged for the costs arising from take-back. Small equipment (and small quantities) might be taken back by your local collection facility.

For Spain: Please contact the established collection system or your local authority for take-back of your used products.

(for Germany only)



Machine Noise Information Regulation - 3. GPSGV,

The highest sound pressure level is less than 70 dB (A) in accordance with EN ISO 7779.









About the symbols

To ensure safe and proper use of the product, this manual uses a number of symbols to prevent injury to you and others as well as damage to property.

The symbols and their meanings are described below. Be sure to understand them thoroughly before reading this manual.

 WARNING	Failing to heed this symbol and handling the product erroneously could result in accidents leading to death or major injury.
 CAUTION	Failing to heed this symbol and handling the product erroneously could result in personal injury or damage to surrounding property.

Examples of symbols

	This symbol indicates you should be careful of electric shocks.
	This symbol indicates you should be careful of high temperatures.
	This symbol indicates something that must be prohibited.
	This symbol indicates something that must not be got wet.
	This symbol indicates you should not touch with wet hands.
	This symbol indicates something that must not be disassembled.
	This symbol indicates things you must do.
	This symbol indicates that the power cord should be unplugged from the power outlet.

Safety Cautions

WARNING

Projected light



PROHIBITED

Projected light and the pictogram/label indicated on the cabinet

- Do not look into the projector's lens.
Strong light that could damage your vision is projected when the projector is operating. Laser energy exposure near aperture may cause burns. Be especially careful when children are around.
- Do not look at the projected light using optical devices (magnifying glasses, reflectors, etc.). Doing so could result in vision impairment.
- Check that there is no one looking at the lens within the projection range before turning on the projector.
- Do not allow children to operate the projector alone. When a child is operating the projector an adult should always be present and watch the child carefully.
- The below pictogram, that is indicated near the lens on the cabinet, describes looking into the projector is prohibited.

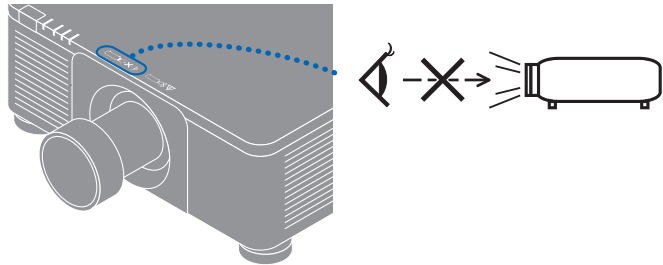

Continue to next page

WARNING

- The following labels are stuck on the projector.

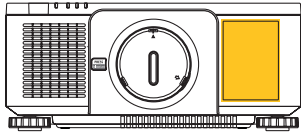

X171Q-B/X171Q-W

<p>This product is in conformity with performance standards for laser products under 21 CFR 1040, except with respect to those characteristics authorized by Variance Number FDA-2019-V-4413 effective on September 19, 2023.</p>	
<p>RISK GROUP 3 WARNING DO NOT LOOK INTO THE BEAM. NO DIRECT EYE EXPOSURE TO THE BEAM IS PERMITTED. HAZARD DISTANCE. REFER TO THE MANUAL.</p> <p>GRUPE DE RISQUE 3 MISE EN GARDE NE PAS REGARDER DIRECTEMENT DANS LE FASCEAU. L'EXPOSITION DIRECTE DES YEUX AU FASCEAU EST INTERDITE. DISTANCE À RISQUE. SE REPORTER AU MANUEL.</p> <p>RISIKOGRUPPE 3 WARNING SCHAUEN SIE NICHT IN DEN STRAHLEN. DIREKTER AUGENKONTAKT MIT DEM STRAHLEN IST NICHT ERLAUBT. SICHERHEITSABSTAND. SEE HANDBUCH.</p> <p>ГРУППА РИСКА 3 ПРЕДУПРЕЖДЕНИЕ НЕ СМОТРИТЕ НА ЛАЗЕР. ЗАПРЕЩАЕТСЯ ПРЯМОЕ ВОЗДЕЙСТВИЕ ЛАЗЕРА НА ГЛАЗА. ОПАСНОСТЬ РАСТОНАНИЕ. СМ. РУКОВОДСТВО ПО ЭКСПЛУАТАЦИИ.</p> <p>リスクグループ 3 警告 ビームを見ないこと。 眼・皮膚への直接照射はできません。 障害距離: 取扱説明書を参照。</p>	<p>危險等級 3 警告 勿直接光線 切勿眼睛對準直接照射 危險距離: 請參閱說明書 IEC/EN 62471-5:2015</p> <p>加給等級 3 警告 請勿直視光束 切勿不要直接對準眼在光束中 危險距離: 參見用戶手冊。 GB/T 30117.5-2019</p>
<p>CLASS 1 LASER PRODUCT LASERPRODUKT DER KLASSE 1 APPAREIL À LASER DE CLASSE 1 ЛАЗЕРНОЕ УСТРОЙСТВО 1 КЛАССА ОПАСНОСТИ</p> <p>クラス1レーザー製品 IEC/EN 60825-1:2014 JIS C 6802: 2018</p>	<p>IEC 60825-1:2014 EN 60825-1:2014+A11-2021 IECEN 62471-5: 2015</p>

This projector is classified as risk group 3 of IEC/EN 62471-5:2015.

X141Q-B/X141Q-W

<p>Complies with 21 CFR 1040.10 and 1040.11 except for conformances to a Risk Group 2 LP as defined in IEC 62471-5:4.5, 5.9. For more information see Laser Notice No. 57, dated May 8, 2019.</p>	
<p>CAUTION ! Do not stare into the beam! RG2 This projector may become RG3 when an interchangeable lens with throw ratio greater than 2.12(0.8 is installed). Refer to the manual for the lens list and hazard distance before operation. Such combinations of projector and lens are intended for professional use only, and are not intended for consumer use.</p> <p>ATTENTION ! Ne pas regarder dans le faisceau RG2 Ce projecteur peut devenir RG3 lorsqu'un objectif interchangeable avec un rapport de projection supérieur à 2,12 est installé. Avant utilisation, reportez-vous au manuel pour trouver la liste des objectifs et la distance de danger. Ces combinaisons de projecteur et d'objectif sont destinées à une utilisation grand public.</p> <p>CLASS 1 LASER PRODUCT APPAREIL À LASER DE CLASSE 1 LASERPRODUKT DER KLASSE 1 ЛАЗЕРНОЕ УСТРОЙСТВО 1 КЛАССА ОПАСНОСТИ 第一級雷射產品 クラス1レーザー製品</p>	<p>注意！請勿直視光束 RG2 當雷射投射比大於2.12:1的可替換鏡頭時, 本雷射會變成RG3產品。 鏡頭及危害距離的說明, 請參考使用手冊。 投影機和鏡頭的這種組合仅供專業人士使用, 不適用於一般消費者, 也不適用於一般家庭。</p> <p>注意！請勿直視光束 RG2 當雷射投射比大於2.12:1的可替換鏡頭時, 本雷射會變成RG3產品。 鏡頭及危害距離的說明, 請參考使用手冊。 投影機和鏡頭的這種組合仅供專業人士使用, 不適用於一般消費者, 也不適用於一般家庭。</p> <p>CLASS 1 LASER PRODUCT APPAREIL À LASER GRAND PUBLIC VERBRAUCHERLASERPRODUKT ЛАЗЕРНОЕ УСТРОЙСТВО 1 КЛАССА ОПАСНОСТИ 第一級雷射產品 クラス1レーザー製品</p> <p>IEC 60825-1:2014 EN 60825-1:2014+A11-2021 EN 9809:2020 IECEN 62471-5: 2015</p> <p>IEC/EN 60825-1:2014 JIS C 6802: 2018</p>
<p>WARNING - MOUNT ABOVE THE HEADS OF CHILDREN! Do not look into the beam that this. No direct eye exposure to the beam is permitted.</p> <p>AVERTISSEMENT - INSTALLER AUDESSUS DE LA TÊTE DES ENFANTS ! Avertissement supplémentaire contre l'exposition oculaire pour les enfants à une distance de montage de 1m.</p>	

- This product complies with EN 50689:2021 except using the lens of XP-62ZL.
- This projector is classified as either IEC/EN 62471-5:2015 risk group 2 or risk group 3 depending on the lens unit.

- When classified as risk group 3, this projector is intended for professional use and must be installed by professional installer to ensure safety. See page [xix](#) for risk groups.
- See page [xvii](#) for Laser Safety Caution.

 **WARNING**

Power supply



REQUIRED

Use a suitable voltage power supply.

- This projector is designed to be used with a 100–240 VAC, 50/60 Hz power supply. Before using the projector, check that the power supply to which the projector is to be connected meets these requirements.
- Use a power outlet as the projector's power supply. Do not connect the projector directly to electrical light wiring. Doing so is dangerous.



**MUST BE
EARTHED**

Connecting the power cord to earth

- This equipment is designed to be used in the condition of the power cord connected to earth. If the power cord is not connected to the earth, it may cause electric shock. Please make sure the power cord is connected to the wall outlet directly and earthed properly. Do not use a 2-pin plug converter adapter.
- Be sure to connect the projector and the computer (signal source) to the same earth point. If the projector and the computer (signal source) will be connected to different earth points, fluctuations in the earth potential may cause fire or smoke.



REQUIRED

Handling the power cord

- Please use the power cord supplied with this projector. If the supplied power cord does not satisfy requirements of your country's safety standard, and voltage and current for your region, make sure to use the power cord that conforms to and satisfies them.

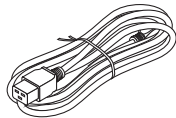

- The power cord you use must be approved by and comply with the safety standards of your country. Please refer to the page 34 about the power cord specification. For selecting an appropriate power cord, please check rated voltage for your region by yourself.



PROHIBITED

- The power cord included with this projector is exclusively for use with this projector. For safety, do not use it with other devices.

Continue to next page

 **WARNING**



**HAZARDOUS
VOLTAGE**

- Handle the power cord with care. Damaging the cord could lead to fire or electric shock.
 - Do not place heavy objects on the cord.
 - Do not place the cord under the projector.
 - Do not cover the cord with a rug, etc.
 - Do not scratch or modify the cord.
 - Do not bend, twist or pull the cord with excessive force.
 - Do not apply heat to the cord.
- Should the cord be damaged (exposed core wires, broken wires, etc.), ask your dealer to replace it.
- Do not touch the power plug should you hear thunder. Doing so could result in electric shock.
- Do not connect or disconnect the power cord with wet hands. Doing so could result in electric shock.



**DO NOT TOUCH
WITH WET
HANDS**

Installation



PROHIBITED

Do not use in places such as those described below.







- Do not use in places such as those described below. Doing so could lead to fire or electric shock.
 - Shaky tables, inclined surfaces or other unstable places.
 - Poorly ventilated spaces.
 - Near a radiator, other heat sources, or in direct sunshine.
 - Continual vibration areas.
 - Humid, dusty, steamy, or oily areas.
 - An environment where there are corrosive gases (sulfur dioxide, hydrogen sulfide, nitrogen dioxide, chlorine, ammonia, ozone, etc.).
 - Outdoors.
 - High-temperature environment where humidity changes rapidly and condensation is likely to occur.
 - Do not use in places such as those described below where the projector could get wet. Doing so could lead to fire or electric shock.
 - Do not use in the rain or snow, on a seashore or waterfront, etc.
 - Do not use in a bathroom or shower room.
 - Do not install under equipment that discharges water, such as air conditioners.
 - Do not place vases or potted plants on the projector.
 - Do not place cups, cosmetics or medicines on the projector.
- Should water, etc. get inside the projector, first turn off the projector's power, then unplug the power cord from the power outlet and contact your dealer.









DO NOT WET









**UNPLUG THE
POWER CORD**

 WARNING	
 CAUTION	<p>Installing suspended from the ceiling</p> <ul style="list-style-type: none"> • Consult your dealer for installing the projector on the ceiling. Special skills are required for ceiling installation. DO NOT perform installation work by people other than installers. Doing so may result in the projector falling and causing injury. • We are not liable for any accident or/and damage resulting from improper installation or handling, misuse, modification, or natural disasters. • When installed suspended from the ceiling, etc. do not hang from the projector. The projector could drop and cause injury. • When installing suspended from the ceiling, use a power outlet that is within reach so the power cord can be easily plugged and unplugged.
On use	
 PROHIBITED  UNPLUG THE POWER CORD	<p>Do not place objects inside the projector.</p> <ul style="list-style-type: none"> • Do not insert or drop metal or combustible objects or other foreign materials into the projector from the vents. Doing so could lead to fire or electric shock. Be particularly careful if there are children in the home. Should a foreign object get inside the projector, first turn off the projector's power, then unplug the power cord from the power outlet and contact your dealer.
 UNPLUG THE POWER CORD	<p>Unplug the power cord if the projector malfunctions.</p> <ul style="list-style-type: none"> • Should the projector emit smoke or strange odors or sounds, or if the projector has been dropped or the cabinet broken, turn off the projector's power, then unplug the power cord from the power outlet. Otherwise it may cause not only fire or electric shock but also serious damage to your eyesight or burns. Contact your dealer for repairs. Never try to repair the projector on your own. Doing so is dangerous.
 DO NOT DISASSEMBLE	<p>Do not disassemble the projector.</p> <ul style="list-style-type: none"> • Do not remove or open the projector's cabinet. Also, do not modify the projector. There are high voltage areas in the projector. It may cause fire, electric shock, or laser light leakage, resulting in serious damage to your eyesight or burns. Have qualified service personnel perform inspection, adjustments and repairs of the interior.

 WARNING	
<p style="text-align: center;"> PROHIBITED</p> <p style="text-align: center;"> CAUTION FOR HIGH TEMPERATURE</p>	<p>Do not place objects in front of the lens while the projector is operating.</p> <ul style="list-style-type: none"> • Do not leave the lens cap on the lens while the projector is operating. The lens cap could get hot and be warped. • Do not place objects in front of the lens that obstruct the light while the projector is operating. The object could get hot and be broken or catch fire. • The below pictogram indicated on the cabinet means the precaution for avoiding to place objects in front of the projector lens. <p style="text-align: center;"></p>
<p style="text-align: center;"> PROHIBITED</p>	<p>When cleaning the projector</p> <ul style="list-style-type: none"> • Do not use flammable gas sprays to remove dust from the lens, cabinet, etc. Doing so could lead to fire.
<p style="text-align: center;"> PROHIBITED</p>	<p>Do not use in high security locations.</p> <ul style="list-style-type: none"> • Usage of the product must not be accompanied by fatal risks or dangers that, could lead directly to death, personal injury, severe physical damage or other loss, including nuclear reaction control in nuclear facility, medical life support system, and missile launch control in a weapon system.

 **CAUTION**

Power cord	
 REQUIRED	<p>Handling the power cord</p> <ul style="list-style-type: none"> • The projector should be installed close to an easily accessible power outlet. • When connecting the power cord to the projector's AC IN terminal, make sure the connector is fully and firmly inserted. Loose connection of the power cord could lead to fire or electric shock.
 REQUIRED  UNPLUG THE POWER CORD	<p>Handling the power cord by following below to avoid fire or electric shock</p> <ul style="list-style-type: none"> • When disconnecting the power cord, pull the power cord out by holding onto its plug. • Unplug the power cord from the power outlet before cleaning the product or when not planning to use the product for an extended time. • When the power cord or plug is heat or damaged, unplug the power cord from the power outlet, and contact your dealer.
 REQUIRED	<p>Periodically clean dust and other debris from the power plug</p> <ul style="list-style-type: none"> • Failure to do so could result in fire or electric shock.
 REQUIRED	<p>Disconnect power cords and other cables before moving the projector</p> <ul style="list-style-type: none"> • Before moving the product, make sure the product power is off, then unplug the power cord from the power outlet and check that all cables connecting the product to other devices are disconnected.
 PROHIBITED	<p>Do not use the power cord with a power tap</p> <ul style="list-style-type: none"> • Adding an extension cord may lead to fire as a result of overheating.

 **CAUTION**

Installation



REQUIRED

Securing the lens unit with the fall prevention wire

- If the projector is going to be suspended from a ceiling or another high place, secure the lens unit using the fall prevention wire (sold separately). If the lens unit is not secured, it may fall down if it comes loose.

On use



PROHIBITED

Do not use on networks subject to overvoltage.

- Connect the projector's HDBaseT port and LAN port to a network for which there is no risk of overvoltage being applied. Overvoltage applied to the HDBaseT or LAN port could result in electric shock.



REQUIRED

Lens shift, focus and zoom operations

- When shifting the lens or adjusting the focus or zoom, do so from either behind or the side of the projector. If adjustments are performed from the front, your eyes could be exposed to strong light and get injured.
- Keep your hands away from the lens area when performing the lens shift operation. If not, your fingers could get caught in the gap between the cabinet and the lens.

 **CAUTION**



PROHIBITED

Handling batteries

Incorrect usage of batteries can result in leaks or bursting.

- Use the specified batteries only.
- Insert batteries matching the (+) and (-) signs on each battery to the (+) and (-) signs of the battery compartment.
- Do not mix battery brands.
- Do not combine new and old batteries. This can shorten battery life or cause liquid leakage of batteries.
- Remove dead batteries immediately to prevent battery acid from leaking into the battery compartment.

If leaked battery fluid gets on your skin or clothing, rinse immediately and thoroughly. If it gets into your eye, bathe your eye well rather than rubbing and seek medical treatment immediately. Leaked battery fluid that gets into your eye or your clothing may cause a skin irritation or damage your eye.

- If you will not use the remote control for a long time, remove the batteries.
- Leaving a battery in an extremely high temperature surrounding environment, or a battery subject to extremely low air pressure, that can result in an explosion or the leakage of flammable liquid or gas.
- Properly dispose of depleted batteries. Disposal of a battery into water, fire, or a hot oven, or mechanically crushing, cutting, or modifying a battery can result in an explosion.
- Do not short-circuit the batteries.
- Do not charge the batteries. The batteries provided are not rechargeable.
- Contact your dealer or local authorities when disposing of batteries.









PROHIBITED



**CAUTION
FOR HIGH
TEMPERATURE**

About the vents

- Do not obstruct the projector's vents. Also, do not place such soft objects as paper or cloths underneath the projector. Doing so could lead to fire. Leave sufficient space between the place where the projector is installed and its surroundings. (→ page xxviii)
- Do not touch the exhaust vent area while projecting or immediately after projecting images. The exhaust vent area may be hot at this time and touching it could cause burns.

 CAUTION	
 PROHIBITED	<p>Moving the projector</p> <ul style="list-style-type: none"> • After the lens unit removed, have at least two people hold the handles to move the projector. Attempting to move the projector alone could result in back pain or other injuries. • When moving the projector, do not hold anywhere but the handles. Otherwise the projector could fall and cause an injury. • When carrying the projector with the lens unit removed, do not touch the mounting area of the lens with your hands. Also, do not put your hand into the recess of the connection terminal. The projector could be damaged or fall down, resulting in injuries.
 REQUIRED	<p>Attaching/detaching the lens</p> <ul style="list-style-type: none"> • Turn off the projector and disconnect the power cord before attaching or detaching the lens unit. Failure to do so could result in visual impairment or burns. • Do not attach or detach the lens unit with the projector installed in a high location. The lens unit could fall and cause damage or injury.
 PROHIBITED	<p>Do not push or climb on the product. Do not grab or hang onto the product. Do not rub or tap the product with hard objects.</p> <ul style="list-style-type: none"> • The product may fall, causing damage to the product or personal injury.
 REQUIRED	<p>Avoid locations with extreme temperatures and humidity</p> <ul style="list-style-type: none"> • Failure to do so could lead to fire or electric shock or damage to the projector. The usage environment for this projector is as follows: <ul style="list-style-type: none"> - The operating temperature: 0°C to 45°C / 32°F to 113°F / humidity: 20 to 80% (without condensation) - The storage temperature: -10°C to 60°C / 14°F to 140°F / humidity: 20 to 80% (without condensation)
<p>Inspections and Cleaning</p>	
 REQUIRED	<p>Inspecting the projector and cleaning the inside</p> <ul style="list-style-type: none"> • Consult with your dealer about once per year for cleaning of the inside of the projector. Dust could accumulate inside of the projector if it is not cleaned for extended periods of time, leading to fires or malfunction.

Laser Safety Caution

X171Q-B/X171Q-W

WARNING

CLASS 1 LASER PRODUCT [IEC 60825-1:2014]

- The laser module is equipped in this product. Use of controls or adjustments of procedures other than those specified herein may result in hazardous radiation exposure. Laser energy exposure near aperture may cause burns.

- This product is classified as Class 1 of IEC 60825-1:2014.
- For EU and UK, This product complies with EN 60825-1:2014+A11:2021.
- Obey the laws and regulations of your country in relation to the installation and management of the device.

For USA

This product is in conformity with performance standards for laser products under 21 CFR 1040, except with respect to those characteristics authorized by Variance Number FDA-2018-V-4413 effective on September 19, 2023.

X141Q-B/X141Q-W

WARNING

CLASS 1 LASER PRODUCT [IEC 60825-1:2014]

CLASS 1 CONSUMER LASER PRODUCT OF EN 60825-1:2014+A11:2021 (For EU and UK)

- The laser module is equipped in this product. Use of controls or adjustments of procedures other than those specified herein may result in hazardous radiation exposure. Laser energy exposure near aperture may cause burns.

- This product is classified as Class 1 of IEC 60825-1:2014.
- For EU and UK, This product complies with EN 60825-1:2014+A11:2021. This product also complies with EN 50689:2021 except using the lens of XP-62ZL.
- Obey the laws and regulations of your country in relation to the installation and management of the device.

For USA

Complies with 21 CFR 1040.10 and 1040.11 except for conformance as a Risk Group 2 LIP as defined in IEC 62471-5:Ed. 1.0. For more information see Laser Notice No. 57, dated May 8, 2019. However, when using the XP-62ZL lens, the following applies.

This product is in conformity with performance standards for laser products under 21 CFR 1040, except with respect to those characteristics authorized by Variance Number FDA-2018-V-4413 effective on September 19, 2023.

 WARNING (For USA)

- Do not allow to look into the projector beam at any distance from the projector. An adult should supervise the children to prevent exposure risks.
- Check that there is no one looking at the lens, when using the remote control for starting the projector.
- Do not look at the projected light using optical devices(binoculars, telescopes, magnifying glasses, reflectors, etc).
- [WARNING: MOUNT ABOVE THE HEADS OF CHILDREN.]
The use of a ceiling mount is recommended with this product to place it above the eyes of children.

-
- Outline of laser emitted from the built-in light module:
 - Wave length: 449 - 461 nm (blue), 635 - 651 nm (red)
 - Maximum power: 456 W (blue), 72 W (red)

Light Module

- A light module containing multiple laser diodes is equipped in the product as the light source.
- These laser diodes are sealed in the light module. No maintenance or service is required for the performance of the light module.
- End user is not allowed to replace the light module.
- Contact qualified distributor for light module replacement and further information.

Risk groups

X171Q-B/X171Q-W

This projector is classified as risk group 3 of IEC/EN 62471-5:2015.

X141Q-B/X141Q-W

This projector is classified as either IEC/EN 62471-5:2015 risk group 2 or risk group 3 depending on the lens unit.

Risk group 2 (RG2)

 **WARNING**

As with any bright light source, do not stare into the beam, RG2 IEC/EN 62471-5:2015.

Risk group 3 (RG3)

 **WARNING**

RG3 PRODUCT OF IEC/EN 62471-5:2015

- When classified as RG3, this projector is for professional use and must be installed in location where safety is assured. For this reason, be sure to consult your dealer as installation must be performed by a professional installer. Never try to install the projector by yourself. This may result in visual impairment etc.
- No direct exposure to the beam shall be permitted, RG3 IEC/EN 62471-5:2015.
- Do not look into the projector's lens. Serious damage to your eyes could result.
- Operators shall control access to the beam within the hazard distance or install the product at the height that will prevent exposures of spectators' eyes within the hazard distance.
- When turning on the power, operate from the side or rear of the projector (outside the hazard zone). Also, when turning on the power, make sure no one within the projection range is looking at the lens.

• Check before installing the projector (For X141Q-B/X141Q-W)

① Lens model name or throw ratio

The lens model name and throw ratio are listed in the image below.

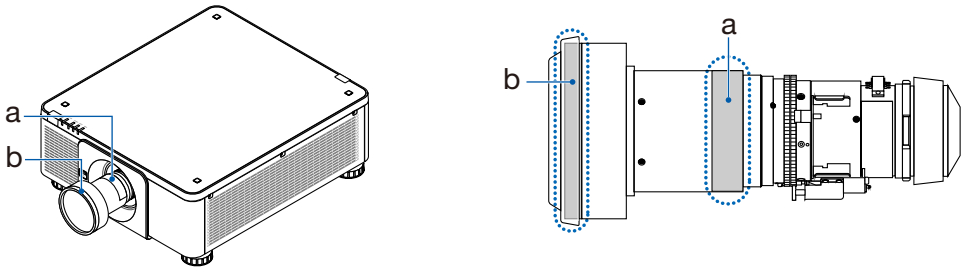

a: Lens model name / b: Throw ratio

② Combining lens units and risk groups

Lens model name	Throw ratio	X141Q-B X141Q-W
XP-57UL	0.31 - 0.33	RG2
XP-58ZL	0.55 - 0.75	
XP-59ZL	0.74 - 1.08	
XP-60ZL	1.05 - 1.41	
XP-61ZL	1.40 - 2.11	
XP-62ZL	2.10 - 4.00	RG3

• Hazard zone

The below figure describes the radiation zone (hazard zone) of light emitted by the projector that is classified as Risk Group 3 (RG3) of IEC/EN 62471-5:2015.

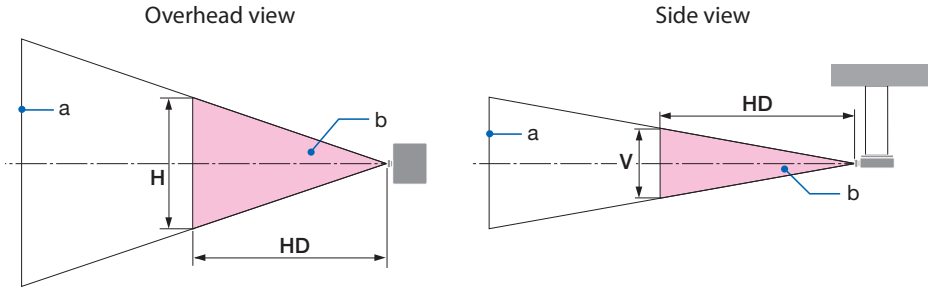

a: Screen / b: Hazard zone

X171Q-B/X171Q-W

Lens	Throw ratio TR@0.8"	Hazard zone (m)		
		HD	H	V
XP-57UL	0.31 (Wide)	0.13	0.41	0.26
	0.33 (Tele)	0.14	0.41	0.26
XP-58ZL	0.55 (Wide)	0.23	0.42	0.26
	0.75 (Tele)	0.40	0.53	0.33
XP-59ZL	0.74 (Wide)	0.33	0.53	0.33
	1.08 (Tele)	0.60	0.60	0.38
XP-60ZL	1.05 (Wide)	0.48	0.54	0.34
	1.41 (Tele)	0.73	0.57	0.35
XP-61ZL	1.40 (Wide)	0.62	0.49	0.31
	2.11 (Tele)	1.16	0.58	0.36
XP-62ZL	2.10 (Wide)	1.18	0.57	0.36
	4.00 (Tele)	2.53	0.66	0.41

X141Q-B/X141Q-W

Lens	Throw ratio TR@0.8"	Hazard zone (m)		
		HD	H	V
XP-62ZL	2.10 (Wide)	-	-	-
	2.12 (Middle)	1.00	0.49	0.31
	4.00 (Tele)	2.11	0.56	0.35

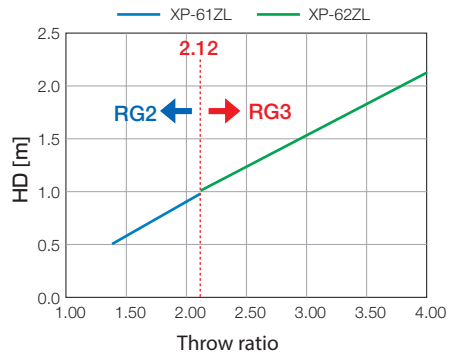

Calculation of the throw ratio

Throw ratio = L: Throw distance (m) / W: Screen width (m)

For throw distances and screen widths, refer to "Lens types and throw distance" in the installation manual.

• About the precautionary zone

By providing a precautionary zone or physical barriers, it is possible to prevent human eyes from entering the hazard zone.

When the manager of the projector (operator) cannot prevent spectators from entering the hazard zone such as in public facilities, it is recommended to secure a space of 1 m or more from the hazard zone as “the precautionary zone” for the safety of the spectators. When installing the projector overhead, it is recommended that the distance between the floor and the hazard zone be at least 3 m in the vertical direction.

In the United States, provide a horizontal distance of 2.5 meters from the hazard zone.

When install the projector overhead, provide a vertical distance of 3 meters from the floor to the hazard zone.

• Installation example considering the precautionary zone (For lens units other than XP-57UL)

① Floor or desktop installation example

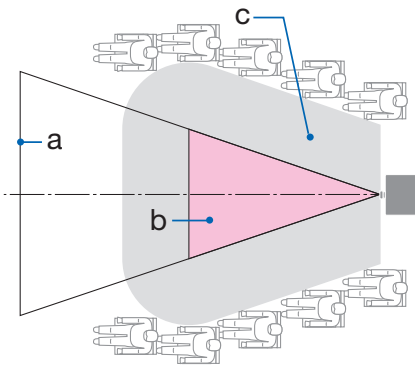

② Ceiling installation example

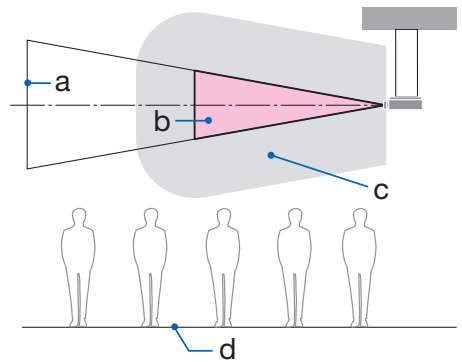

a: Screen / b: Hazard zone / c: Precautionary zone / d: floor

 <p>CAUTION</p>	<p>If it is expected that spectators will intrude into the hazard zone when installed on the ceiling, it is necessary to prevent spectators from entering that area.</p>
---	--

③ **Example of downward projection installed on the ceiling**

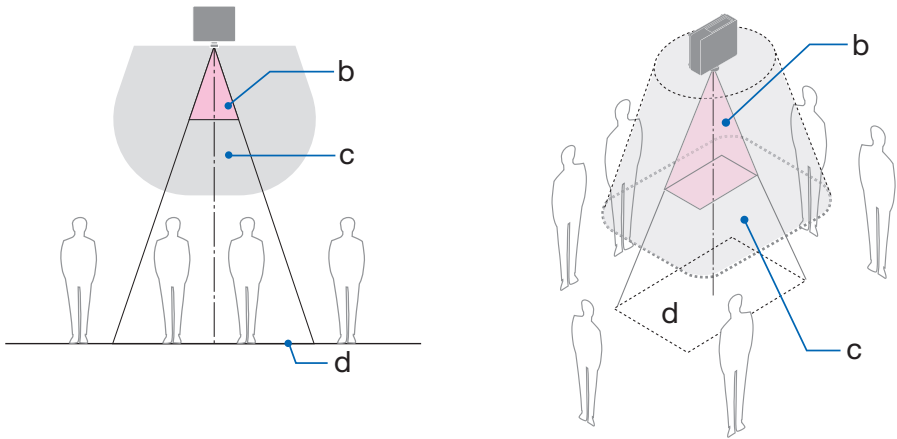

a: Screen / b: Hazard zone / c: Precautionary zone / d: floor

 <p>CAUTION</p>	<p>If the precautionary zone between the floor and the hazard zone cannot be secured, it is necessary to prevent spectators from entering the area around the screen as shown in the figure on the right.</p>
---	---

* If using lens shift, please consider the shift of projected image according to the volume of lens shift. Installation example considering the precautionary zone

• Installation example considering the precautionary zone (For XP-57UL)

① Floor or desktop installation example

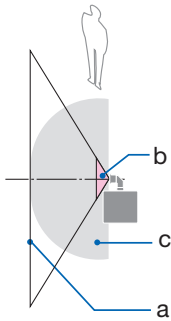

② Ceiling installation example

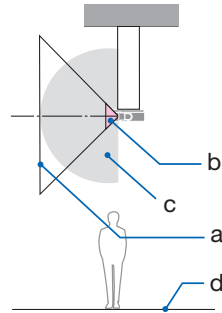

a: Screen / b: Hazard zone / c: Precautionary zone / d: Floor

 <p>CAUTION</p>	<p>If the precautionary zone cannot be secured between the floor and the hazard zone, spectators must be restricted from entering the space between the projector and screen.</p>
---	---

* The above figure is an example of a typical installation. It is also necessary to secure the precautionary zone when installing the projector at an angle.



Please follow all safety precautions.

Installing the projector

- When planning the layout of the projector, make sure to follow the safety measures listed in the installation Manual.
- In order to avoid danger, either install the device within easy reach of a wall outlet or provide a device like a breaker to disconnect power to the projector in emergency.
- Take safety measures to prevent human eyes from entering the hazard zone.
- Select an appropriate lens for the installation location and secure the safety zone set for each lens.
Ensure that appropriate safety measures have been taken when operating the projector, adjusting the light, etc.
- Check whether the appropriate safety zone for the installed lens has been adequately secured. Periodically check the zone and maintain a record of verifications.

The installer or dealer must instruct the manager (operator) of the projector of the following:

- Educate the manager of the projector (operator) about safety before operating the projector.
- Instruct the manager of the projector (operator) to perform inspections (including safety checks on light emitted by the projector) before powering the projector on.
- Instruct the manager of the projector (operator) to be able to control the projector whenever the projector is powered on in case of an emergency.
- Instruct the manager of the projector (operator) to keep the installation Manual, user's manual and inspection records in an easy-to-reach place.
- Instruct them to determine whether the projector conforms to the standards of each country and region.

Notes on installation and maintenance

Do not install or store in such places as those described below.

- Locations that amplify vibrations and impacts
If installed in places where the vibrations from power sources and the like are conveyed, or in vehicles or on vessels, etc. the projector could be affected by vibrations or shocks that may damage internal parts and lead to malfunction.
- Close to high voltage power lines and power sources
It could disrupt the unit.
- Places where strong magnetic fields are generated
Doing so could lead to malfunction.
- Outdoors and places with humid or dust
Places exposed to oil smoke or steam
Places where corrosive gases are generated
Attached substances such as oil, chemicals and moisture may cause deformation or cracks of the cabinet, corrosion of the metal parts, or malfunction.

To the dealer and the installer

When installing the projector, please see the Installation Manual provided on our web site.

1. To prevent the projector from falling, install it on the ceiling in a way with sufficient strength to withstand the combined weight of the projector and the ceiling mount unit for an extended period of time.
2. When installing the projector on the ceiling, be sure to do so correctly in accordance with the installation Manual for the Ceiling Mount Unit. Be sure to use the fixed metal fittings and to tighten the screws securely.
3. To prevent the projector from falling, use fall prevention wires.
 - Use commercially available metal fittings to join the robust part of a building or construction and the security bar of the projector with the fall prevention wires.
 - Use commercially available metal fittings and fall prevention wires that have sufficient strength to withstand the combined weight of the projector and the ceiling mount unit.
 - Slightly slack off the fall prevention wires so as not to put a load on the projector.
 - Refer to the "Part Names of the Projector" for the location of the security bar. (→ page 6)

Securing personal information

Personally identifiable information, such as IP addresses, may be saved on the projector.

Before transferring or disposing of the projector, clear this data by performing [RESET] on the on-screen menu.

For items that cannot be reset, please clear them individually.

Cautions for ensuring the projector's performance

- If intense light like laser beams enters from the lens, it could lead to malfunction.
- Consult your dealer before using in places where much cigarette smoke or dust is present.
- When the projector is used at high altitudes (places where the atmospheric pressure is low), it may be necessary to replace the optical parts sooner than usual.
- About moving the projector
 - Detach the lens unit once, and be sure to attach the lens cap so as not to scratch the lens. Also, attach a dust protective cap to the projector.
 - Do not subject the projector to vibrations or strong shocks.
The projector could be damaged otherwise.
- Do not use the tilt feet for purposes other than adjusting the projector's tilt. Improper handling, such as carrying the projector by the tilt feet or using it leaned against a wall, could lead to malfunction.
- Do not touch the surface of the projection lens with bare hands. Fingerprints or dirt on the surface of the projection lens will be enlarged and projected on the screen. Do not touch the surface of the projection lens.
- Do not unplug the power cord from the projector or the power outlet while projecting. Doing so could cause deterioration of the projector's AC IN terminal or power plug contact. To interrupt the AC power supply while images are being projected, use a breaker, etc.
- About handling of the remote control
 - The remote control will not work if the projector's remote signal sensor or the remote control's signal transmitter is exposed to strong light or if there are obstacles between them that obstruct the signals.
 - Operate the remote control from within 7 meters from the projector, pointing it at the projector's remote signal sensor.
 - Do not drop the remote control or handle it improperly.
 - Do not let water or other liquids get on the remote control. Should the remote control get wet, wipe it off immediately.
 - Avoid using in hot and humid places as far as possible.
- Take measures to prevent external light from shining on the screen. Make sure only the light from the projector shines on the screen. The less external light on the screen, the higher the contrast and the more beautiful the images.
- About screens
 - Images will not be clear if there is dirt, scratches, discoloration, etc. on your screen. Handle the screen with care, protecting it from volatile substances, scratches and dirt.
- Concerning to all maintenance operations, refer to Installation Manual and follow all instructions properly.

Clearance for Installing the Projector

- When installing the projector, keep sufficient space around it, as described below. If not, the hot exhaust emitted from the projector may be taken back in. Also, make sure no wind from an air-conditioner hits the projector. The projector's heat control system may detect an abnormality (temperature error) and automatically shut off the power.

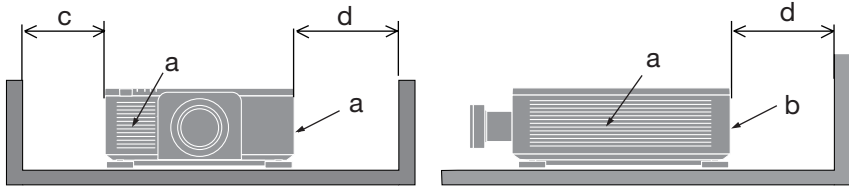

a: Intake vent / b: Exhaust vent / c: 30 cm/12" or greater / d: 50 cm/20" or greater

NOTE:

- In the above figure, it is assumed that there is sufficient space above the projector.
- When using multiple projectors together for multi-screen projection, provide sufficient space around the projectors for air intake and exhaust. When the intake and exhaust vents are obstructed, the temperature inside the projector will rise and this may result in a malfunction.

**About Copyright of original projected pictures:**

Please note that using this projector for the purpose of commercial gain or the attraction of public attention in a venue such as a coffee shop or hotel and employing compression or expansion of the screen image with the following functions may raise concern about the infringement of copyrights which are protected by copyright law.

[ASPECT RATIO], [KEYSTONE], Magnifying feature and other similar features.

REGISTER YOUR PROJECTOR! (for residents in the United States and Mexico)

Please take time to register your new projector. This will activate your limited parts and labor warranty and InstaCare service program.

Visit our web site at <https://www.sharpnecdisplays.us/product-registration> and submit your completed form online.

Upon receipt, we will send a confirmation letter with all the details you will need to take advantage of fast, reliable warranty and service programs from the industry leader, Sharp Imaging and Information Company of America.

Trademarks

- ProAssist is trademark or registered trademark of Sharp NEC Display Solutions, Ltd. in Japan, in the United State and other countries.
- The terms HDMI, HDMI High-Definition Multimedia Interface, HDMI Trade dress and the HDMI Logos are trademarks or registered trademarks of HDMI Licensing Administrator, Inc.



- HDBaseT™ and the HDBaseT Alliance logo are trademarks of the HDBaseT Alliance.



- DisplayPort™ and the DisplayPort™ logo are trademarks owned by the Video Electronics Standards Association (VESA®) in the United States and other countries.
- DLP® and the DLP logo are trademarks or registered trademarks of Texas Instruments in the United States and other countries.
- Trademark PJLink is a trademark applied for trademark rights in Japan, the United States of America and other countries and areas.
- Blu-ray is a trademark of Blu-ray Disc Association.
- Crestron™ and Crestron Connected™ are trademarks or registered trademarks of Crestron Electronics, Inc. in the United States and other countries.
- Other product and company names mentioned in this user's manual may be the trademarks or registered trademarks of their respective holders.

1. Check the product overview, supplied items and part names

1-1. Introduction to the Projector

This section introduces you to your new projector and describes the features and controls.

- **Single-chip DLP projector with high resolution and high brightness**

Realized to project the image in the resolution 3840 × 2400 pixels (4K), the aspect ratio in 16:10.

Model name	Brightness
X171Q-B/X171Q-W	16500 lm (100 - 130 VAC: 14000 lm)
X141Q-B/X141Q-W	13500 lm

- **A proprietary sealed structure that achieves highly dust-proof performance**

Due to its excellent dust-proof performance, the projector is not equipped with a filter. Filter replacement is therefore unnecessary.

- **A long-life laser diode is equipped in the light module**

The laser light source has a long service life, so replacement, adjustment, and other maintenance should not be necessary for an extended period of time.

- **Wide range of optional lenses selectable according to the place of installation**

This projector supports 6 types of optional lenses, providing a selection of lenses adapted to a variety of places of installation and projection methods.

Note that no lens is mounted upon shipment from the factory. Please purchase optional lenses separately.

- **360 degree free projection**

The projector is equipped with a “tilt-free” function for 360° projection vertically and a “roll-free” function for 360° projection horizontally.

- **Power lens control for quick and easy adjustment**

By using buttons on the projector or the remote control, zoom, focus, and position (lens shift) can be adjusted.

- **A variety of input terminals such as HDMI, DisplayPort, HDBaseT, SDI, etc.**

The projector is equipped with HDMI (1/2), DisplayPort (1/2), HDBaseT, SDI (IN/OUT) input terminals.

The projector’s HDMI input terminals and DisplayPort input terminals support HDCP.

HDBaseT, promoted and advanced by the HDBaseT Alliance, is a consumer electronic (CE) and commercial connectivity technology.

- **Multi-screen projection using multiple projectors**

You can line up multiple projectors to display a high resolution image in a larger screen.

Furthermore, the boundaries of the screens are smoothed using an edge blending function.

- **Supports wired LAN**

Equips the LAN and HDBaseT ports. Utilizing a wired LAN connected with these ports, it enables to control the projector by a computer.

1. Check the product overview, supplied items and part names

- **Convenient utility software (User Supportware)**

This projector supports our utility software (NaViSet Administrator 2, ProAssist, etc.).

NaViSet Administrator 2 helps you control the projector by a computer via wired LAN connection.

ProAssist is software allowing you for example to control the projector's lens from the computer connected to the projector by a LAN cable. Some of the functions in ProAssist may not be compatible with the projector.

Please visit our web site for downloading each software.

URL: <https://www.sharp-nec-displays.com/dl/en/index.html>

- **Crestron Connected compatibility**

The projector supports Crestron Connected, allowing multiple devices connected in the network to be managed and controlled from a computer.

For details, refer to the Crestron Electronics, Inc. website.

<https://www.crestron.com/>

* The projector does not support XiO Cloud.

1. Check the product overview, supplied items and part names

1-2. What's in the Box?

Make sure your box contains everything listed. If any pieces are missing, contact your dealer. Please save the original box and packing materials if you ever need to ship your projector.

Projector

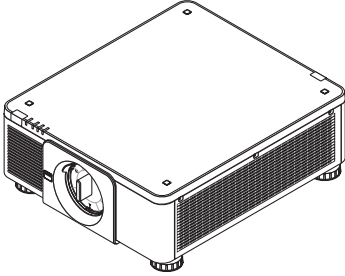

Dust cap for lens

* The projector is shipped without a lens.

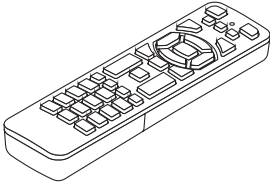

Remote control

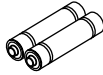

AAA alkaline batteries (x2)

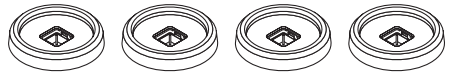

4 Stacking holders

[X171Q-B/X171Q-W] Power cord (x 3)

[X141Q-B/X141Q-W] Power cord (x 2)

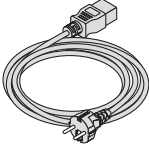
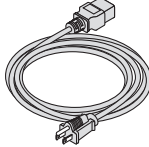
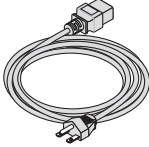
		[X171Q-B/X171Q-W only] 
For Europe/Asia/South America	(for AC 120 V)	(for AC 200 V)
For North America		

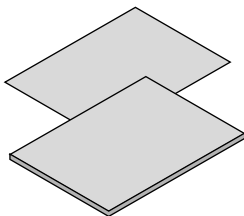

- Important Information
- Quick Setup Guide

For USA only

Limited warranty

For customers in Europe

You will find our current valid Guarantee Policy on our Web Site:

<https://www.sharpnecdisplays.eu>

1-3. Part Names of the Projector

Front

The lens is sold separately. The description below is for when the XP-61ZL lens is mounted.

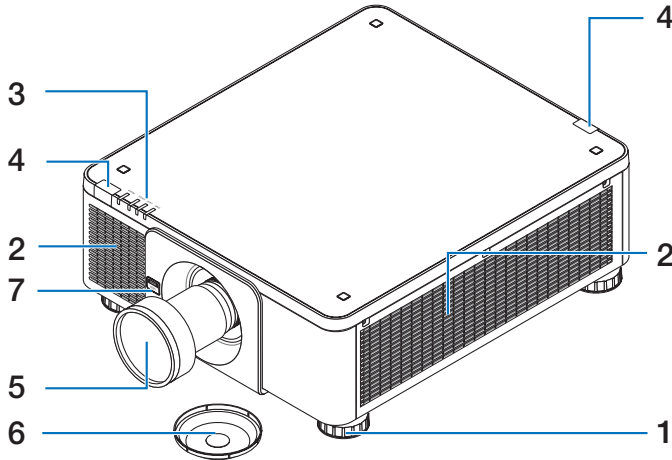

1. Adjustable Tilt Foot

Rotate the tilt foot to adjust the left/right orientation.

2. Intake vent

Takes in outside air to cool the unit.

3. Indicator Section

The indicator light turns on or blinks to relay the status of the projector (Power ON/ Standby/etc.)

4. Remote Sensor

This part receives signals from the remote control. There are two locations on the front and back of the projector.

5. Lens

Images are projected from here. (Lens unit sold separately.)

6. Lens Cap

(The optional lens is shipped with the lens cap.)

7. Lens Release (LENS) Button

This is used to remove the lens unit.

1. Check the product overview, supplied items and part names

Rear

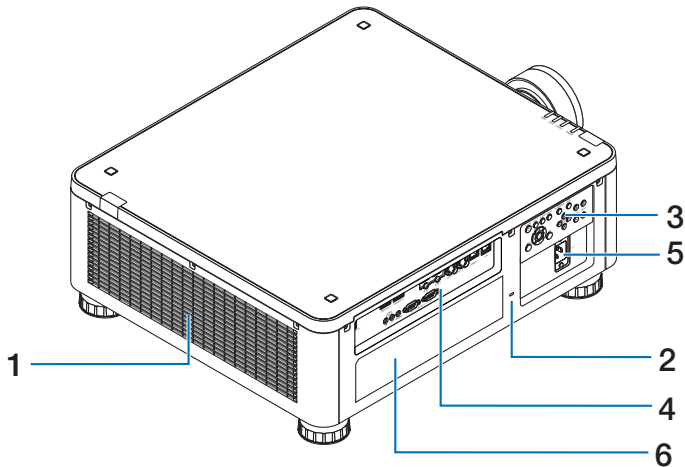

1. Exhaust vent

Heated air is exhausted from here.

2. Security Slot (K)*

This is used when attaching an anti-theft cable.

3. Controls

The projector's power can be turned ON/OFF, and the signal for the projected image can be switched here.

4. Terminals

Connect the cables for the various video signals.

5. AC IN Terminal

Connect the supplied power cord's three-pin plug here, and plug the other end into an active wall outlet.

6. Label

* Security and theft protection lock compatible with Kensington security cables/equipment. For products, visit Kensington's website.

1. Check the product overview, supplied items and part names

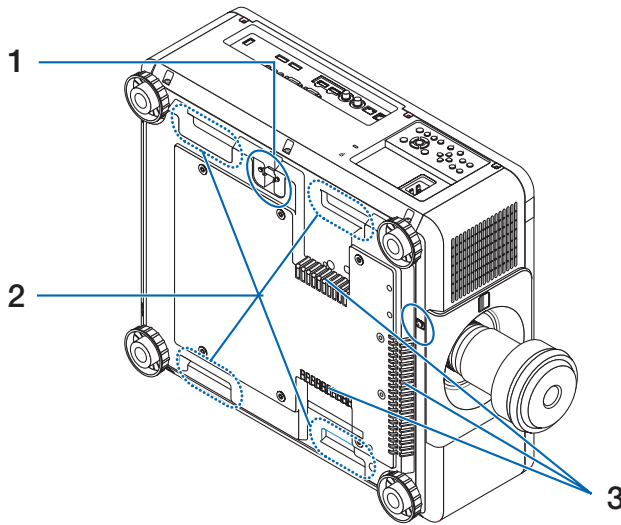

1. Security Bar

Attach an anti-theft device. The security bar accepts security wires or chains up to 0.18 inch/4.6 mm in diameter.

2. Handle (located on 4 positions)

For transportation.

3. Intake vent

Takes in outside air to cool the unit.

CAUTION:

For moving the projector, make sure you have at least two people. At the same time, do not grip and hold the projector other than by these handles. Attempting to move the projector alone could result in back pain or other injuries.

1. Check the product overview, supplied items and part names

Controls/Indicators

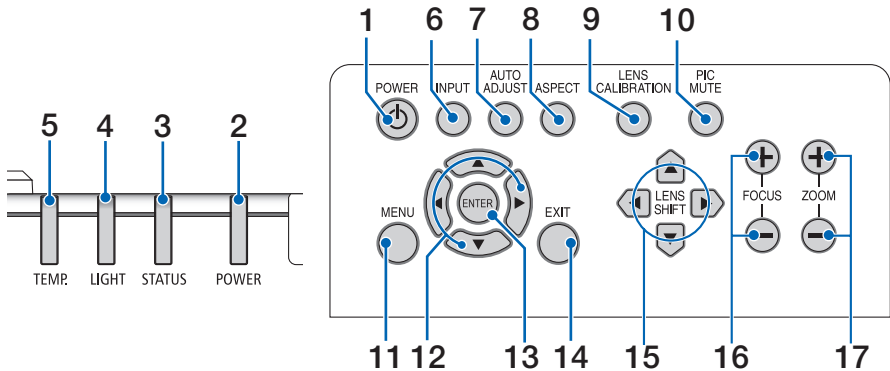

1. (POWER) Button

Switches between projector's power on and standby.

When turning off the power (standby), pressing the button once will bring up a confirmation message on the screen, so press the button one more time.

2. POWER Indicator

Indicates the projector's power state. The indicator lights up in green when the power is on. Depending on the state of power, it will light up or blink in either red or orange when power is off. Refer to the "Indicator Message" section for details.

(→ page 36)

3. STATUS Indicator

This lights up or blinks when an operation button is pressed while the unit is in key lock mode, while the lens is calibrating, etc. Refer to the "Indicator Message" section for details.

(→ page 36)

4. LIGHT Indicator

Indicates the state of the light source.

5. TEMP. Indicator

Indicates high temperatures around the projector.

6. INPUT Button

Selects the input signal. Pressing it quickly will display the input selection screen. Pressing it for one second or longer will begin a series of automatic checks in the order of HDMI1 → HDMI2 → DisplayPort1 → DisplayPort2 → HDBaseT → SDI, and if an input signal is detected then that signal will be projected.

7. AUTO ADJUST Button

Automatically adjusts the projected image to the optimal condition.

8. ASPECT Button

This switches the aspect ratio each time it is pressed.

9. LENS CALIBRATION Button

The lens unit and lens shift adjustment range are calibrated and the lens is shifted back to the home position.

1. Check the product overview, supplied items and part names

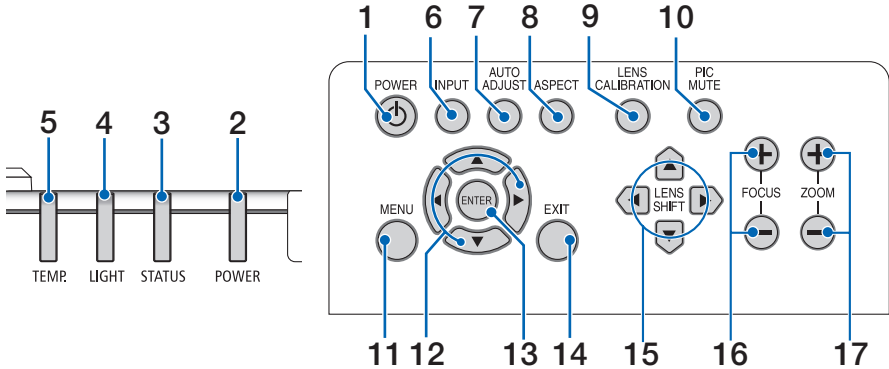

10. PIC MUTE Button

Turns off the image for a short period of time. Press the button again to unmute.

11. MENU Button

Displays the on-screen menu for various settings and adjustments.

12. ▲▼◀▶ Buttons

- When the on-screen menu is displayed, use the ▼▲◀▶ buttons to select the item that you wish to set or adjust.
- Changes the pattern when the test pattern is displayed.

13. ENTER Button

Moves to the next menu when the on-screen menu is displayed. Confirms the item when the confirmation message is displayed.

14. EXIT Button

Close the menu when the on-screen menu is displayed.

Cancels the operation when the confirmation message is displayed.

15. SHIFT Button

Adjust the position of the projected image.

16. FOCUS Button

Adjust the focus of the projected image.

17. ZOOM Button

Adjust the size of the projected image.

1. Check the product overview, supplied items and part names

Terminal Panel Features

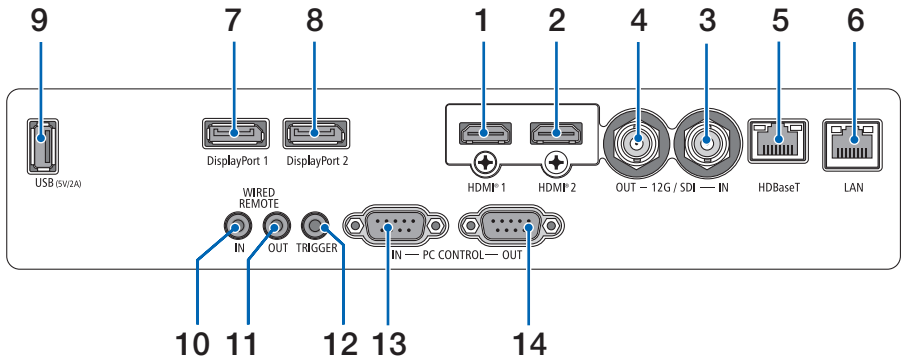

1. HDMI 1 Terminal (Type A)

Connects to the output terminals of a computer, blu-ray player, etc.

2. HDMI 2 Terminal (Type A)

Connects to the output terminals of a computer, blu-ray player, etc.

3. SDI IN Terminal (BNC)

Connects to the SDI output terminal on the video device.

4. SDI OUT Terminal (BNC)

Outputs the video signal input to the SDI IN terminal.

5. HDBaseT Port (RJ-45)

Connects to a commercially available HDBaseT compatible transmission devices.

6. LAN Port (RJ-45)

Connects the unit to a wired LAN.

7. DisplayPort 1 Terminal

Connects to the DisplayPort output terminal on a computer, etc.

8. DisplayPort 2 Terminal

Connects to the DisplayPort output terminal on a computer, etc.

9. USB Port (Type A)

Supplies a 5.0V/2.0A power source when the projector's power is turned on.

10. WIRED REMOTE IN Terminal (Stereo Mini)

Use this terminal for wired remote control of the projector.

NOTE:

- When a remote control cable is connected to the REMOTE terminal, infrared remote control operations cannot be performed.

1. Check the product overview, supplied items and part names

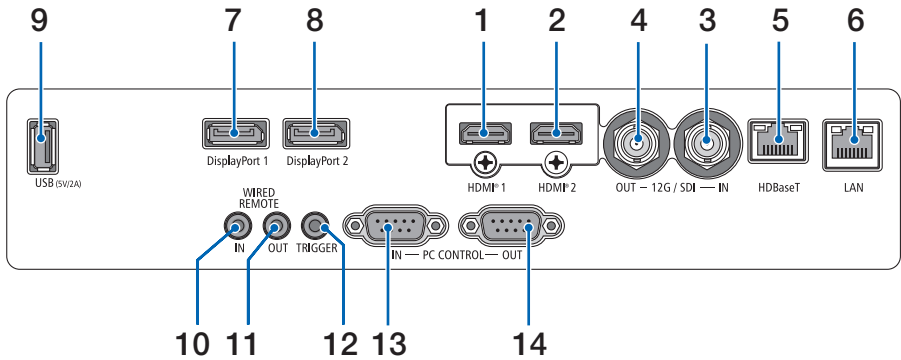

11. WIRED REMOTE OUT Terminal

Outputs the video signal input to the WIRED REMOTE IN terminal.

12. TRIGGER Terminal

When the projector's power is turned on, outputs a control voltage for the screen. Connect a screen controller or other device to control such things as the screen height when the projector's power is turned on and off.

13. PC CONTROL IN Port (D-Sub 9 Pin)

Use this port to connect a PC or control system. This enables you to control the projector using serial communication protocol.

14. PC CONTROL OUT Port (D-Sub 9 Pin)

Outputs the control signal input to the PC CONTROL IN port.

1. Check the product overview, supplied items and part names

1-4. Part Names of the Remote Control

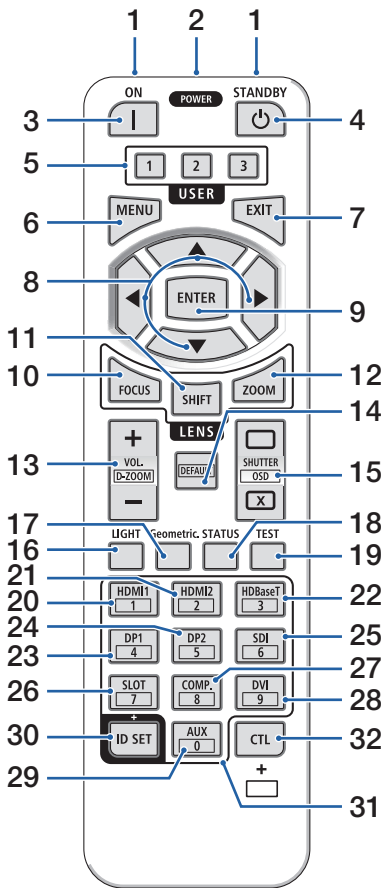

1. Infrared Transmitter

Remote control signals are sent via infrared signal. Point the remote control at the remote control receiver on the projector.

2. Remote Jack

Connect a commercially available remote cable here for wired operation.

3. POWER ON Button (|)

Turns power ON when in standby mode.

4. POWER STANDBY Button ()

Pressing the button once will display the shutdown confirmation message. Press the POWER STANDBY (or ENTER) button once more to power down the projector.

5. USER 1/2/3 Button

USER1: Automatically adjusts the projected image to the optimal condition.

USER2/3: (Not available on this series of projectors.)

6. MENU Button

Displays the on-screen menu for various settings and adjustments.

7. EXIT Button

Closes the menu when the on-screen menu is displayed. Cancels the operation when the confirmation message is displayed.

8. ▲▼◀▶ Button

- When the on-screen menu is displayed, use the ▼▲◀▶ buttons to select the item that you wish to set or adjust.
- Changes the pattern when the test pattern is displayed.

9. ENTER Button

Moves to the next menu when the on-screen menu is displayed. Confirms the item when the confirmation message is displayed.

1. Check the product overview, supplied items and part names

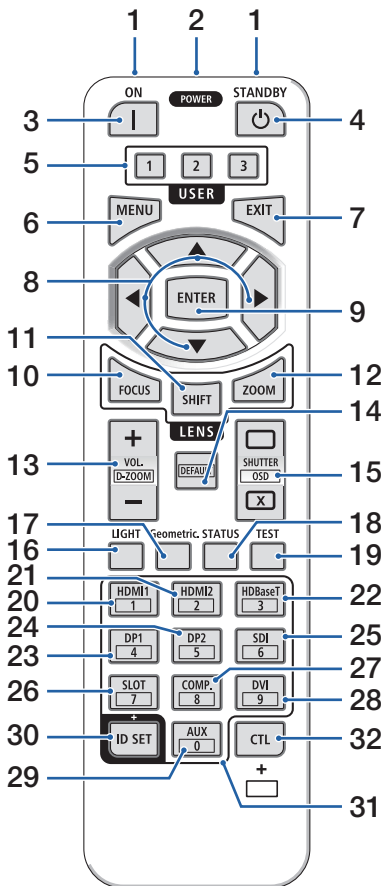

10. FOCUS Button

Opens the focus adjustment screen. Adjust the focus (of the lens) with the ◀ / ▶ buttons.

11. SHIFT Button

The lens shift adjustment screen will be displayed. Use the ▼▲◀▶ buttons to adjust the lens position.

12. ZOOM Button

Opens the zoom adjustment screen. Adjust zoom with the ▼▲ buttons.

13. VOL./D-ZOOM (+)(-) Button

Simultaneously pressing the CTL button will expand or shrink the image (return to the original state).

14. DEFAULT Button

(Not available on this series of projectors.)

15. SHUTTER/OSD OPEN (□)/CLOSE (X) Button

Press the CLOSE button to turn off the light source and temporarily stop projection. Press the OPEN button to resume. Simultaneously press the CTL and CLOSE buttons to close the on-screen display (On-Screen Mute). Simultaneously press the CTL and OPEN buttons to go back.

16. LIGHT Button

This switches [REF. LIGHT MODE] each time it is pressed.

17. Geometric. Button

Displays [DISPLAY] from the on-screen menu.

18. STATUS Button

Displays [INFO.] from the on-screen menu.

19. TEST Button

Projects a test pattern.

20. HDMI1 Button

Selects the HDMI1 input.

21. HDMI2 Button

Selects the HDMI2 input.

1. Check the product overview, supplied items and part names

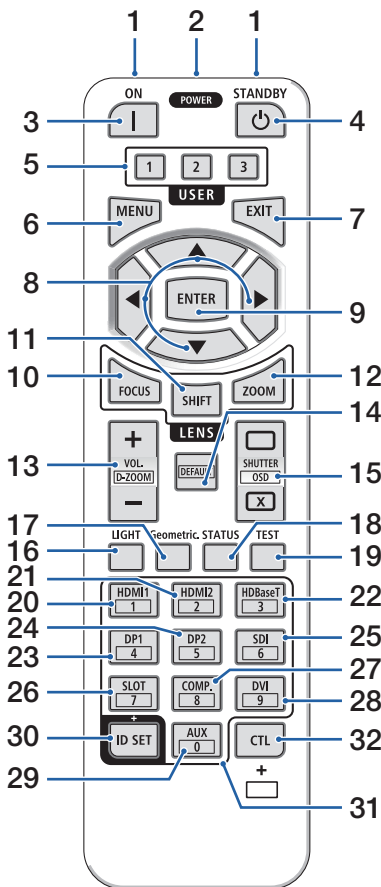

22. HDBaseT Button

Selects the HDBaseT input.

23. DP1 Button

Selects the DisplayPort1 input.

24. DP2 Button

Selects the DisplayPort2 input.

25. SDI Button

Selects the SDI input.

26. SLOT Button

(Not available on this series of projectors.)

27. COMP. Button

(Not available on this series of projectors.)

28. DVI Button

(Not available on this series of projectors.)

29. AUX Button

(Not available on this series of projectors. For future expansion)

30. ID SET Button

Used to set the control ID when performing individual operations on multiple projectors using the remote control.

31. Numeric Keypad Button

Used to input the control ID when performing individual operations on multiple projectors using the remote control (set the control ID). Pressing the 0 button while holding down the ID SET button will remove any control ID settings.

32. CTL Button

This is a multipurpose button for combined use with other buttons.

Battery Installation

1. Press the catch and remove the battery cover.

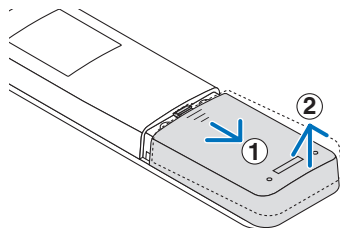

2. Install AAA alkaline batteries. Ensure that you have the batteries' polarity (+/-) aligned correctly.

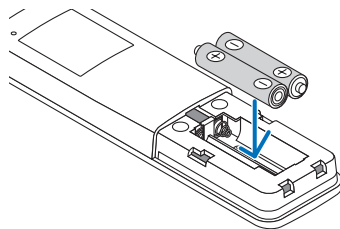

3. Slip the cover back over the batteries until it snaps into place.

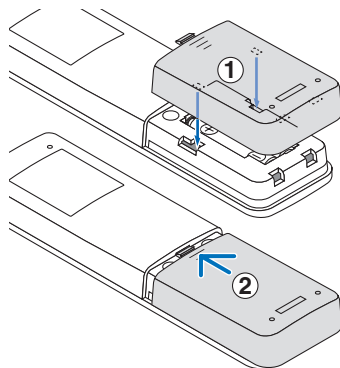

NOTE:

- When replacing the batteries, purchase 2 of the same type of AAA alkaline batteries.
-

Remote Control Precautions

- Handle the remote control carefully.
- If the remote control gets wet, wipe it dry immediately.
- Avoid excessive heat and humidity.
- Do not short, heat, or take apart batteries.
- Do not throw batteries into fire.
- If you will not be using the remote control for a long time, remove the batteries.
- Ensure that you have the batteries' polarity (+/-) aligned correctly.
- Do not use new and old batteries together, or use different types of batteries together.
- Dispose of used batteries according to your local regulations.
- Please note that if multiple projectors are installed nearby, other projectors may unintentionally light up when you turn on the power using the remote control.

1. Check the product overview, supplied items and part names

Operating Range for Wireless Remote Control

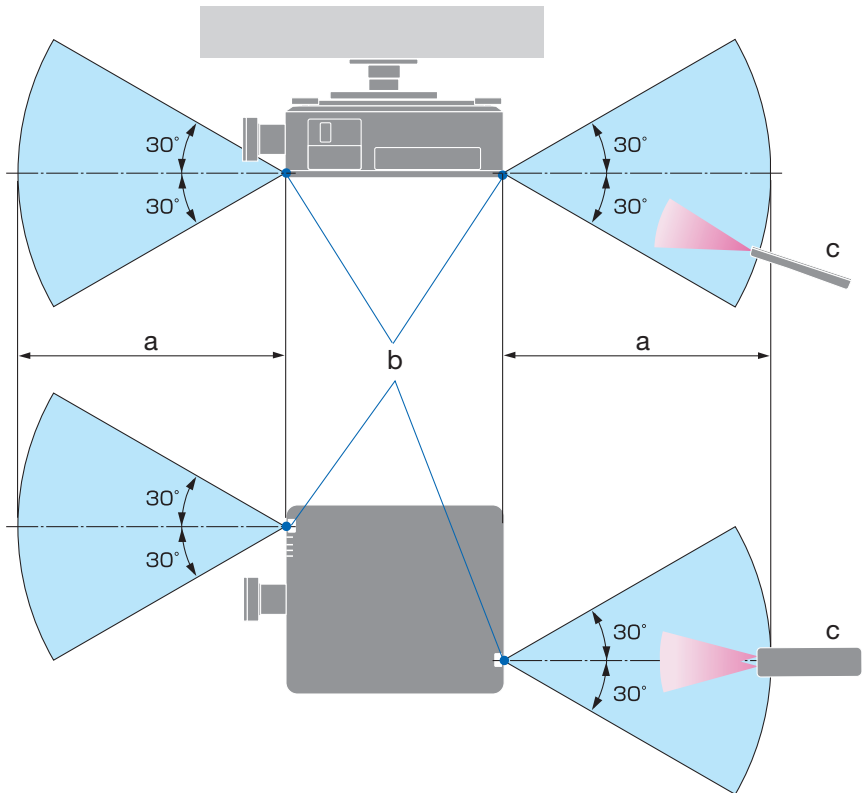

a: 7 m/276" / b: Remote sensor on projector cabinet / c: Remote control

- The projector will not respond if there are objects between the remote control and the sensor, or if strong light falls on the sensor. Weak batteries will also prevent the remote control from properly operating the projector.

1. Check the product overview, supplied items and part names

Using the Remote Control in Wired Operation

Connect one end of the remote cable to the REMOTE terminal and the other end to the remote jack on the remote control.

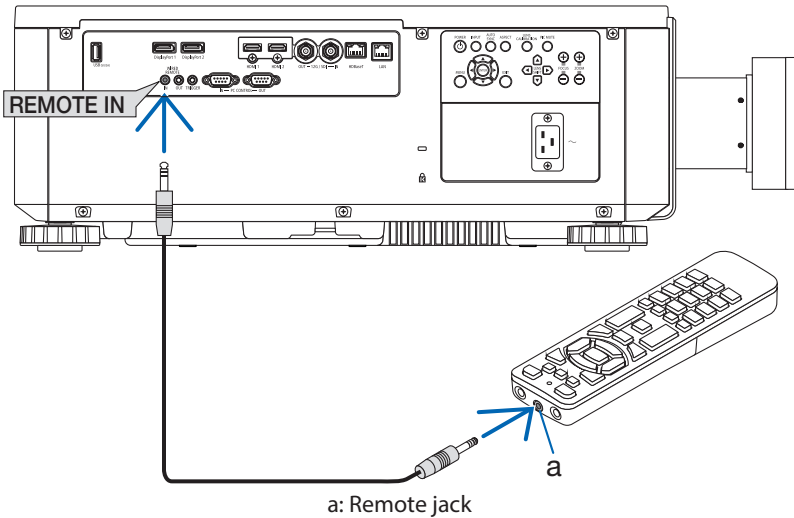

NOTE:

- When a remote cable is inserted into the REMOTE terminal, the remote control does not work for infrared wireless communication.
- Power will not be supplied to the remote control by the projector via the REMOTE jack. Battery is needed when the remote control is used in wired operation.

2. Projecting an Image (Basic Operation)

This section describes how to turn on the projector and to project a picture onto the screen.

2-1. Flow of Projecting an Image

Step 1

- **Connecting your computer / Connecting the power cord** (→ [page 18](#))



Step 2

- **Turning on the projector** (→ [page 20](#))



Step 3

- **Selecting a source** (→ [page 23](#))



Step 4

- **Adjusting the picture size and position** (→ [page 24](#))



Step 5

- **Making a presentation**



Step 6

- **Turning off the projector** (→ [page 31](#))



Step 7

- **After use** (→ [page 32](#))

2-2. Connecting Your Computer/Connecting the Power Cord

1. Connect your computer to the projector.

This section will show you a basic connection to a computer.

Connect a commercially available HDMI cable between the computer's HDMI output connector and the projector's HDMI 1 IN or HDMI 2 IN connector.

2. Connect the supplied power cord to the projector.

First connect the supplied power cord's three-pin plug to the AC IN terminal of the projector, and then connect another plug of the supplied power cord directly in the wall outlet. Do not use any plug converter.



CAUTION:

- This equipment is designed to be used in the condition of the power cord connected to earth. If the power cord is not connected to the earth, it may cause electric shock. Please make sure the power cord is connected to the wall outlet directly and earthed properly. Do not use a 2-core plug converter adapter.
- Be sure to connect the projector and the computer (signal source) to the same earth point. If the projector and the computer (signal source) will be connected to different earth points, fluctuations in the earth potential may cause fire or smoke.
- To prevent the power cord from coming loose, make sure that all the prongs of the power cord plug are fully inserted into the AC IN terminal of the projector. A loose contact of the power cord may cause a fire or electric shock.

Upon connecting the power cable, the POWER indicator of the projector will light.

2. Projecting an Image (Basic Operation)

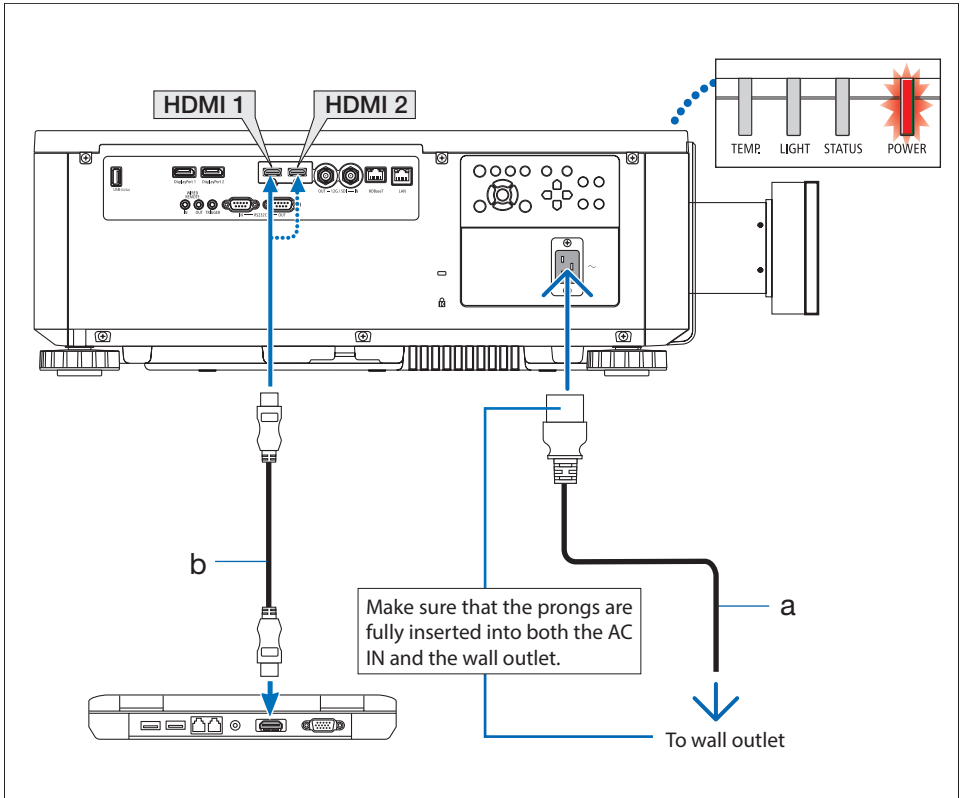

a: Power cord (supplied) / b: HDMI cable (not supplied)

- Use a Premium High Speed HDMI Cable.

CAUTION:

Parts of the projector may become temporarily heated if the projector is turned off with the POWER button or if the AC power supply is disconnected during normal projector operation. Use caution when picking up the projector.

2-3. Turning on the Projector

WARNING

The projector produces a strong light. When turning on the power, operate from the side or rear of the projector (outside the hazard zone). Also, when turning on the power, make sure no one within the projection range is looking at the lens.

1. Remove the lens cap.

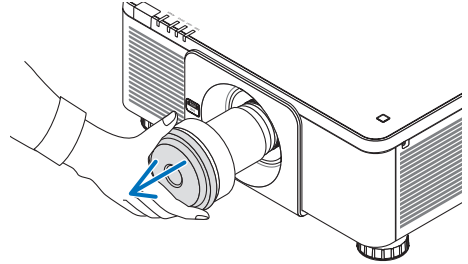

2. Press the (POWER) button on the projector cabinet or the POWER ON button on the remote control.

The POWER indicator lit in red will start to blink in green. After that, the image will be projected onto the screen.

After you turn on your projector, ensure that the computer or video source is turned on.

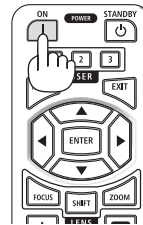

NOTE:

- A blue screen (blue background) is displayed when no signal is being input (by factory default menu settings).

Performing Lens Calibration

After installation or replacement of the lens, be sure to perform [LENS CALIBRATION] by pressing the LENS CALIBRATION button on the projector cabinet. Perform [LENS CALIBRATION] also when trouble is found on the lens shift motion. Calibration corrects the adjustable lens shift range. Also, perform [LENS CALIBRATION] when an error occurs in the lens shift operation.

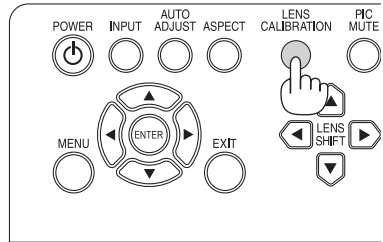

Note on Startup screen (Menu Language Select screen)

When you first turn on the projector, you will get the Startup menu. This menu gives you the opportunity to select one of the 9 menu languages.

To select a menu language, follow these steps:

1. Use the ▲ or ▼ button to select one of the 9 languages from the menu.

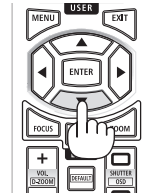
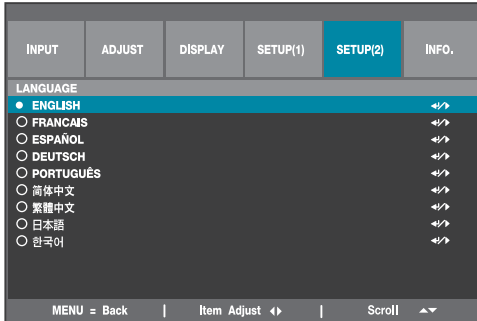

2. Press the ENTER button to execute the selection.

After this has been done, you can proceed to the menu operation.

If you want, you can select the menu language later.

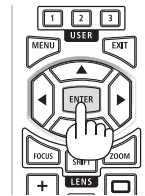

NOTE:

- Keep the lens cap off the lens while the projector's power is on.
If the lens cap is on, it could be warped due to high temperature.
- While the POWER indicator is blinking green in short cycles, the power cannot be turned off by using the power button.
- If the projector is kept in sleep mode or other similar state, the temperature of the internal components could rise even when the projector is being used within its normal operating temperature. If the power is turned on in that state, the cooling fan will turn on and the image will be projected after a short while.

2-4. Selecting a Source

Selecting the computer or video source

NOTE:

- Turn on the computer or video source equipment connected to the projector.

Using the buttons on the projector cabinet

Pressing the INPUT button will switch to the next input source.

HDMI1 → HDMI2 → DisplayPort1 → DisplayPort2 → HDBaseT
→ SDI → HDMI1 → ...

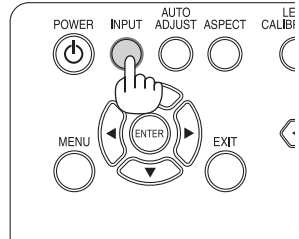

Using the Remote Control

Press the HDMI1 or HDMI2 button.

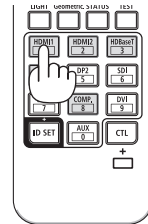

2-5. Adjusting the Picture Size and Position

Use the lens shift, the adjustable tilt foot, the zoom and the focus to adjust the picture size and position.

Repeat these adjustments until you obtain the optimal projection conditions.

In this chapter drawings and cables are omitted for clarity.

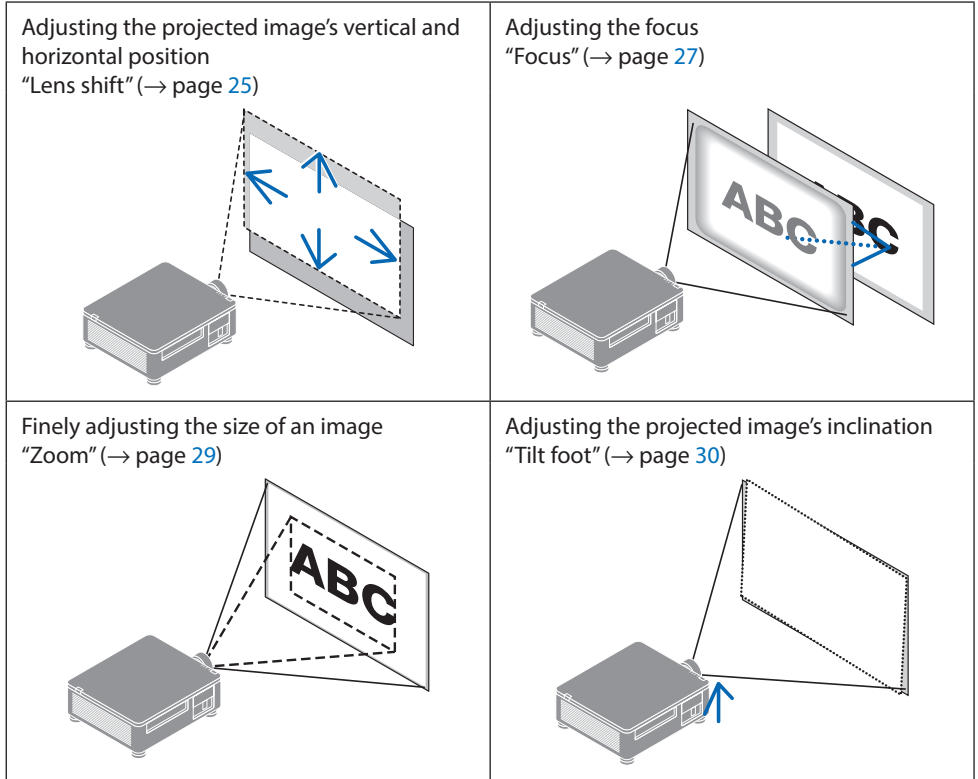

NOTE:

- The SHIFT, FOCUS and ZOOM buttons on the remote control will not function while the test pattern is being projected. When using the remote control, adjust the setting by pressing the MENU button to open the on-screen menu and then selecting [DISPLAY]→[LENS]→[LENS CONTROL].

Adjusting the vertical position of a projected image (Lens shift)

CAUTION

- Perform the adjustment from behind or from the side of the projector. If adjustments are performed from the front, your eyes could be exposed to strong light and get injured.
- Keep hands away from the lens mounting portion while performing a lens shift. Failure to do so could result in fingers being pinched by the moving lens.

Using the buttons on the projector cabinet

1. Press the **LENS SHIFT**     buttons to move the projected image.

Using the Remote Control

1. Press the **SHIFT** button.

The [LENS CONTROL (SHIFT)] screen will be displayed.

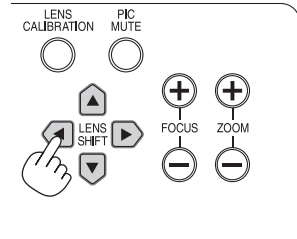

2. Press the    buttons to move the projected image.

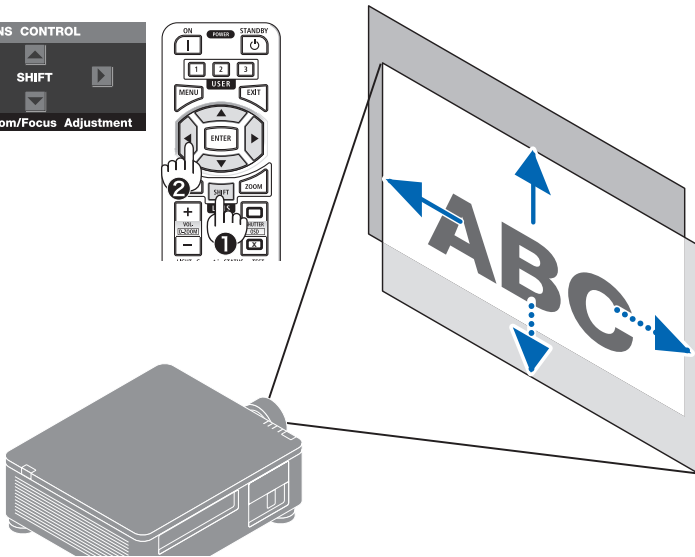
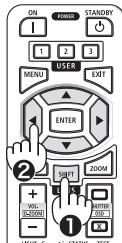

2. Projecting an Image (Basic Operation)

To set back the lens to the home position

Press the LENS CALIBRATION button. The lens mounted on the projector goes back to the home position. (roughly to the center position)

NOTE:

- If the lens is shifted to the maximum in the diagonal direction, the screen peripheral area will be dark or shaded.

TIP:

- The figure below shows the lens shift adjustment range (projection method: Desktop/Front) of the XP-61ZL lens unit.

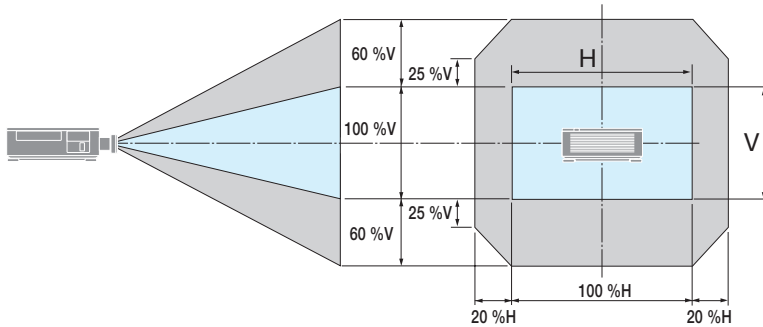

Description of symbols: V indicates vertical (height of the projected image), H indicates horizontal (width of the projected image).

FOCUS

① Adjust the focus around the optical axis (Powered focus)

Using the buttons on the projector cabinet

1. Press the FOCUS (+) or (-) button to align focus around the optical axis.

- * The picture shows an example when the lens shift is moved upward. Adjust the lens until the bottom edge of the projection screen is in focus.

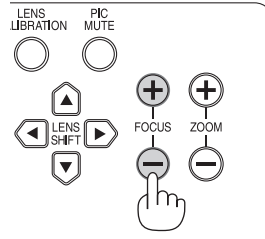

Using the Remote Control

1. Press the FOCUS or ZOOM button.

The [LENS CONTROL (ZOOM/FOCUS)] screen will be displayed on.



2. Press either ◀ or ▶ button to align focus around the optical axis.

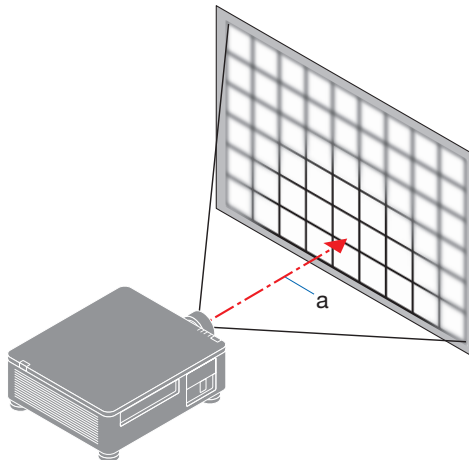
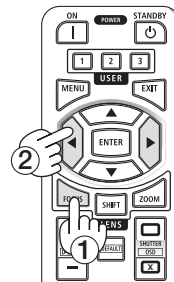

a: Optical axis

2. Projecting an Image (Basic Operation)

② Adjust the focus of screen peripheral area (Manual focus)

Turn the peripheral focus ring clockwise or counterclockwise.

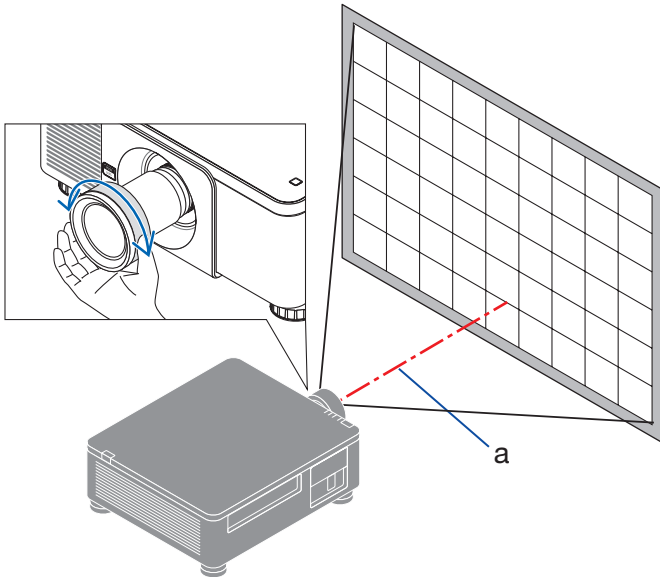

③ Repeat steps ① and ② until the entire projection screen is in focus.

Zoom

Using the buttons on the projector cabinet

1. Press the ZOOM (+) or (-) button to adjust zoom.

Using the Remote Control

1. Press the ZOOM or FOCUS button.

The [LENS CONTROL (ZOOM/FOCUS)] screen will be displayed on.

2. Press **▲▼** button to adjust zoom.

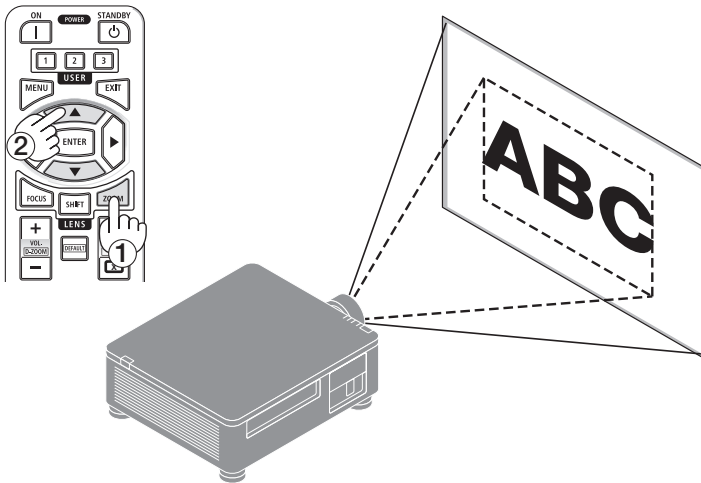
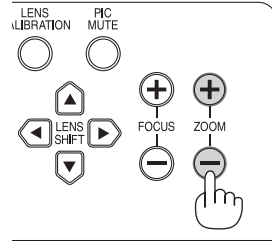
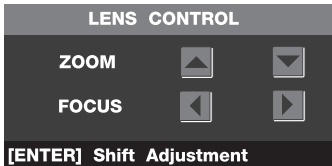

Adjusting the Tilt Foot

1. The position to project image may be adjusted by the tilt foot positioned at four corners of the cabinet bottom.

The tilt foot height can be adjusted by its turn.

"To adjust the height of the projected image"

The height of the projected image is adjusted by turning either front or rear tilt foot.

"If the projected image is tilted"

If the projected image is tilted, turn either left or right tilt foot to adjust the image so that it is level.

- The tilt foot can be lengthened by a maximum of 10 mm.
- The tilt foot can be used to tilt the projector by a maximum of 1°.

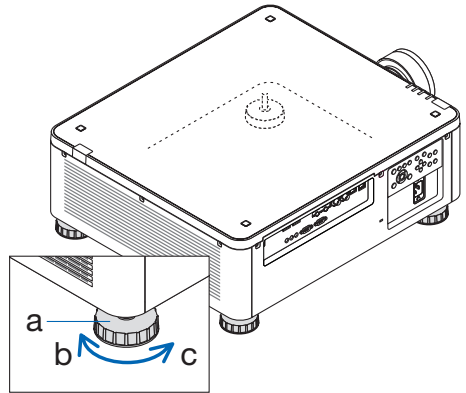
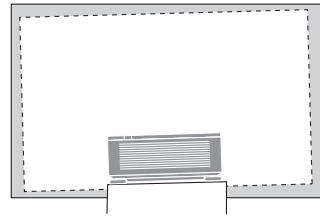

a: Tilt foot / b: Up / c: Down

NOTE:

- Do not lengthen the tilt foot any more than 10 mm/0.4". Doing so will make the projector unstable.
- Pay attention to lengthen or shorten two tilt foot at front at the same time. Same for the rear foot, otherwise, the weight of the projector is loaded on one side and it may cause of damage to it.
- Do not use the tilt foot for any purpose other than adjusting inclination of the projector installation angle. Handling the tilt foot improperly, such as carrying the projector by grasping the tilt foot or hooking it onto a wall using the tilt foot, could damage the projector.

2-6. Turning off the Projector

To turn off the projector:

1. First, press the  (POWER) button on the projector cabinet or the STANDBY button on the remote control.

The [POWER OFF / ARE YOU SURE ?] message will appear.

**POWER OFF
ARE YOU SURE ?**

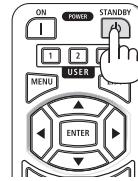

2. Secondly, press the  (POWER) or the STANDBY button again.

The light source will be turned off and the power supply will be cut.



CAUTION

- Parts of the projector may become temporarily heated if the projector is turned off with the POWER button or if the AC power supply is disconnected during normal projector operation. Use caution when picking up the projector.

NOTE:

- While the POWER indicator is blinking green in short cycles, the power cannot be turned off.
- Do not unplug the power cord from the projector or from the power outlet while an image is being projected. Doing so could deteriorate the projector's AC IN terminal or the power plug's contact. To turn off the AC power while an image is being projected, use the breaker, etc.
- Do not disconnect the AC power supply to the projector within 10 seconds of making adjustment or setting changes and closing the menu. Doing so can cause loss of adjustments and settings.

2-7. After Use

1. Unplug the power cord.
2. Disconnect any other cables.
3. Mount the lens cap on the lens.
4. Before moving the projector, screw in the tilt foot if they have been lengthened.

3. Appendix

3-1. Specifications

Model name		X171Q-B/X171Q-W	X141Q-B/X141Q-W
Method		Single DLP® chip	
Resolution		9,216,000 pixels (3840 dots × 2400 lines)	
Specifications of main parts			
DMD panel	Size	0.8" (aspect ratio: 16:10)	
	Pixels ^{(*)1}	2,304,000 (1920 dots × 1200 lines)	
Projection lenses	Refer to the specifications of option lens (→ 35 page)		
	Zoom	Motorized	
	Focus	Motorized	
	Lens shifting	Motorized	
Light source		Laser diode with Phosphor	
Light output ^{(*)2} ^{(*)3}		16500 lm (100 VAC: 14000 lm)	13500 lm
Screen size (throw distance)		50" - 600" (Throw distance depends on the lens)	
Color reproducibility		10-bit color processing (approx. 1.07 billion colors)	
Scanning frequency	Horizontal	15 kHz, 24 to 153 kHz	
	Vertical	24, 25, 30, 48 Hz, 50 to 85 Hz, 100, 120 Hz	
Input/output connectors			
HDMI 1/2	Video input	Type A × 2 Deep Color, LipSync, HDCP ^{(*)4} , 4K	
HDBaseT	Video input	RJ-45 x1, Deep Color, LipSync, HDCP ^{(*)4} , 4K	
	Control	100BASE-TX, PLink class1	
SDI IN	Video input	BNC x1 12G	
SDI OUT	Video output	BNC x1 12G	
DisplayPort 1/2	Video input	DisplayPort × 2	
		Deep Color, LipSync, HDCP ^{(*)4} , 4K	
USB		USB type A × 1, 5.0 V/2.0 A power supply	
Control Terminals	LAN	RJ-45 × 1, 10BASE-T/100BASE-TX, PLink class1	
	PC CONTROL IN	D-Sub 9-pin × 1	
	PC CONTROL OUT	D-Sub 9-pin × 1	
	WIRED REMOTE IN	Stereo mini jack × 1	
	WIRED REMOTE OUT	Stereo mini jack × 1	
	TRIGGER	Stereo mini jack × 1	
Built-in Speaker		Not applicable	
Usage environment ^{(*)5}		Operating temperature: 32 to 113°F (0 to 45°C) Operating humidity: 20 to 80% (with no condensation) Storage temperature: 14 to 140°F (-10 to 60°C) Storage humidity: 20 to 80% (with no condensation) Operating altitude: 0 to 3000 m/10000 feet	
Power supply		100-240 VAC, 50/60 Hz	
Power consumption		1200 W (100-130VAC) 1270 W (200-240VAC)	1080 W (100-240 VAC)
Power consumption (Standby state)	Network enabled	3.0 W (100-240 VAC)	
	Network disabled	0.5 W (100-240 VAC)	
Rated input current		12.0 A (100-130VAC) – 6.4 A (200-240VAC)	10.0 A (100-130 VAC) – 5.0 A (200-240 VAC)

Model name	X171Q-B/X171Q-W	X141Q-B/X141Q-W
Power cord specification	15 A or higher	
External dimensions	19.7" (width) × 8.5" (height) × 23.0" (depth)/ 500 mm (width) × 216 mm (height) × 583 mm (depth) (not including protruding parts)	
	19.7" (width) × 8.5" (height) × 23.9" (depth)/ 500 mm (width) × 216 mm (height) × 606 mm (depth) (including protruding parts)	
Weight	65.0 lbs/29.5 kg (not including lens)	63.9 lbs/29.0 kg (not including lens)

- *1 Effective pixels are more than 99.99%.
 - *2 This is the brightness when lens unit XP-61ZL (sold separately) is attached and [REF. LIGHT MODE] is set to [NORMAL], [REF. LIGHT ADJUST] is set to [100], and [PRESET] is set to [STANDARD]. Using [REF. LIGHT ADJUST] will reduce brightness. If any other mode is selected as the [PRESET] mode, the light output value may drop slightly.
 - *3 Compliance with ISO21118-2020
 - *4 If you are unable to view material via the HDMI input, this does not necessarily mean the projector is not functioning properly. With the implementation of HDCP, there may be cases in which certain content is protected with HDCP and might not be displayed due to the decision/intention of the HDCP community (Digital Content Protection, LLC).
Video: HDR, Deep Color, 8/10/12-bit, Lip Sync.
Audio: LPCM; up to 2 ch, sample rate 32/44.1/48 KHz, sample bit; 16/20/24-bit
HDMI: Supports HDCP 2.2/1.4
HDBaseT: Supports HDCP 2.2/1.4
DisplayPort: Supports HDCP 1.3
 - *5 The projector's protection functions will activate depending on the temperature of the operating environment.
- For additional information visit:
US: <https://www.sharpnecdisplays.us>
Europe: <https://www.sharpnecdisplays.eu>
Global: <https://www.sharp-nec-displays.com/global/>
For information on our optional accessories, visit our website or see our brochure.
The specifications are subject to change without notice.

Option lens (sold separately)

XP-57UL	Motorized lens shift, Motorized zoom, Motorized focus (Throw ratio 0.31 - 0.33:1 F 2.05 - 2.11, f= 5.81 - 6.17 mm)
XP-58ZL	Motorized lens shift, Motorized zoom, Motorized focus (Throw ratio 0.55 - 0.75:1 F 2.04 - 2.35, f= 10.03 - 13.60 mm)
XP-59ZL	Motorized lens shift, Motorized zoom, Motorized focus (Throw ratio 0.74 - 1.08:1 F 2.02 - 2.33, f= 13.47 - 16.67 mm)
XP-60ZL	Motorized lens shift, Motorized zoom, Motorized focus (Throw ratio 1.05 - 1.41:1 F 1.90 - 2.08, f= 8.78 - 25.30 mm)
XP-61ZL	Motorized lens shift, Motorized zoom, Motorized focus (Throw ratio 1.40 - 2.11:1 F 1.80 - 2.11, f= 25.04 - 37.57 mm)
XP-62ZL	Motorized lens shift, Motorized zoom, Motorized focus (Throw ratio 2.10 - 4.00:1 F 1.90 - 2.44, f= 37.23 - 70.60 mm)

NOTE:

- The above throw ratio is for projecting on 100" screen.
- The release date of XP-57ZL and XP-58ZL is undecided.

Please refer to our web site for release schedule.

3-2. Troubleshooting

This section helps you resolve problems you may encounter while setting up or using the projector.

Feature of each indicator

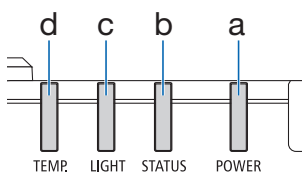





























a: POWER indicator





b: STATUS indicator

c: LIGHT indicator

d: TEMP. indicator

Indicator Message (Status message)

POWER	STATUS	LIGHT	TEMP.	Projector status
 Off	 Off	 Off	 Off	Power is off
 Orange (Blink ^{*1})	 Off	 Off	 Off	Now switching to the standby mode Main unit now cooling
 Red (Light)	 Off	 Off	 Off	In the state of Standby (Network is unavailable)
 Orange (Light)	 Off	 Off	 Off	In the state of Standby (Network is available)
 Green (Light)	 Off	 Green (Light)	 Off	Powered state
Status varies	 Orange (Blink ^{*2})	Status varies	 Off	[LENS CALIBRATION] implement request.
 Green (Light)	 Green (Blink ^{*2})	Status varies	 Off	Performing the lens calibration
 Green (Light)	Status varies	 Green (Blink ^{*3})	 Off	Shutter function is activating















POWER	STATUS	LIGHT	TEMP.	Projector status
 Green (Blink*1)	 Off	 Off	 Off	Preparing for powering [ON]

*1 Repetition to light on for 0.5 seconds / off for 0.5 seconds

*2 Repetition to light on for 0.5 seconds / off for 0.5 seconds / on for 0.5 seconds / off for 2 seconds

*3 Repetition to light on for 0.5 seconds / off for 5 seconds

Indicator Message (Error message)

POWER	STATUS	LIGHT	TEMP.	Projector status	Procedure
 Green (Light)	 Off	 Orange (Light)	 Off	Temperature problem	Ambient temperature is high. The projector's protection functions will activate depending on the temperature of the operating environment. Lower the room temperature.
 Green (Light)	 Off	 Off	 Red (Blink*1)	Temperature problem	Ambient temperature is out of the operation temperature. Check if any obstruction stays near the exhaust vent.
Status varies	 Red (Blink*4)	 Off	 Off	Lens mounting error	Lens is not mounted properly. Mount it.
Status varies	 Red (flashing other than as describe above) Or (lit)	Status varies	 Off	Error requiring service support	Contact your dealer or service personnel. Make sure to check and inform indicator status for asking to repair.
	Status varies	 Red (Blink*2,*4)			

*1 Repetition to light on for 0.5 seconds / off for 0.5 seconds

*2 Repetition to light on for 0.5 seconds / off for 0.5 seconds / on for 0.5 seconds / off for 2 seconds

*4 Repetition to light on for 0.5 seconds / off for 2 seconds

When the thermal protector is activated:

When inside temperature of the projector becomes too high or low, the TEMP. indicator start to red blink in a short cycle. After this happened, the thermal protector will activate and the projector may be turned off.

In this case, please take the below measures:

- Pull out the power plug from the wall inlet.
- Place the projector in cool place if it has been placed in high ambient temperature.
- Clean the exhaust vent if dust has accumulated on.
- Leave the projector for about one hour until inside temperature gets lower.

Common Problems & Solutions

Problem	Check These Items
Does not turn on or shut down	<ul style="list-style-type: none"> • Check that the power cord is plugged in and that the power button on the projector cabinet or the remote control is on. • Check to see if the projector has temperature error, If projector inside temperature is too hot or cool, it disabled to turn on the projector as the protection. Wait for a moment and try turn on the projector again. • In case it's hard to think the trouble is not caused on the above mentioned conditions, unplug the power cord from the outlet. Then wait 5 minutes before plugging it in again.
Will turn off	<ul style="list-style-type: none"> • Ensure that the [AUTO POWER OFF] is off.
No picture	<ul style="list-style-type: none"> • Check if the appropriate input is selected. If there is still no picture, press the INPUT button or one of the input buttons again. • Ensure your cables are connected properly. • Use menus to adjust the brightness and contrast. • Check that the SHUTTER CLOSE button is not pressed. • Reset the settings or adjustments to factory preset levels using the [RESET] in the Menu. • If the HDMI input signal cannot be displayed, try the following. Reinstall your driver for the graphics card built in your computer, or use the updated driver. For reinstalling or updating your driver, refer to the user guide accompanied with your computer or graphics card, or contact the support center for your computer manufacturer. Install the updated driver or OS on your own responsibility. We are not liable for any trouble and failure caused by this installation. • The signal may not be supported depending on the HDBaseT transmission device. In addition, RS232C interface may not be supported. • If the projector is kept in sleep mode or other similar state, the temperature of the internal components could rise even when the projector is being used within its normal operating temperate. If the power is ON when that occurs, the cooling fan will turn on and it will take a little bit of time before the image is projected. Please wait for a while.
Picture suddenly becomes dark	<ul style="list-style-type: none"> • A hot room may trigger the projector's protection functions, which can result in a temporary reduction in luminance (brightness). Reduce the temperature in the room.
Image isn't square to the screen	<ul style="list-style-type: none"> • Reposition the projector to improve its angle to the screen. • Perform [GEOMETRIC CORRECTION] when the trapezoid is distorted.
Picture is blurred	<ul style="list-style-type: none"> • Adjust the focus. • Reposition the projector to improve its angle to the screen. • Ensure that the distance between the projector and screen is within the adjustment range of the lens. • Has the lens been shifted by an amount exceeding the guaranteed range? • Condensation may form on the lens if the projector is cold, brought into a warm place and is then turned on. Should this happen, let the projector stand until there is no condensation on the lens.
Image is scrolling vertically, horizontally or both	<ul style="list-style-type: none"> • Check the computer's resolution and frequency. Make sure that the resolution you are trying to display is supported by the projector.

Problem	Check These Items
Remote control does not work	<ul style="list-style-type: none">• Aim the remote control's infrared transmitter towards the projector's remote control receiver.• Install new batteries.• Make sure there are no obstacles between you and the projector.• Stand within 7 m/276 inch of the projector.• If a [CONTROL ID] has been set, check whether the ID number for the remote control matches the ID number for the projector.
On-screen menu is not displayed	<ul style="list-style-type: none">• Check whether On-screen mute is active. On-screen mute can be turned off in the following ways:<ul style="list-style-type: none">- Press the OSD OPEN button while holding down the CTL button on the remote control.
Indicator is lit or blinking	<ul style="list-style-type: none">• See the Indicator Message.

For more information contact your dealer.

3-3. Mounting a lens (sold separately)

Six separate bayonet style lenses can be used with this projector. The descriptions here are for the XP-61 ZL lens. Mount other lenses in the same manner.

After installing or replacing the lens unit, press the LENS CALIBRATION button on the projector to carry out [LENS CALIBRATION]. By carrying out [LENS CALIBRATION], the lens unit and lens shift adjustment range are calibrated.

WARNING:

(1) Turn off the power and wait for the cooling fan to stop, (2) disconnect the power cord and wait for the unit to cool before mounting or removing the lens. Failure to do so can result in eye injury, electric shock, or burn injuries.

Important:

- The projector and lenses are made of precision parts. Do not subject them to shock or excessive forces.
- Remove the separately sold lens when moving the projector. If not, the lens could be subject to shock while the projector is being moved, damaging the lens and the lens shift mechanism.
- If the projector must be moved with the lens unit attached, such as when it is installed in a high or specific location, use the screws included with the lens unit to secure it to the projector. Do not hold the lens when moving the projector.
- When dismantling the lens from the projector, return the lens position to the home position before turning off the power. Failure to do so may prevent the lens from being mounted or dismantled because of narrow space between the projector and the lens.
- Never touch the lens surface while the projector is operating.
- Be very careful not to let dirt, grease, etc., on the lens surface and not to scratch the lens surface.
- Perform these operations on a flat surface over a piece of cloth, etc., to prevent the lens from getting scratched.
- When leaving the lens off the projector for long periods of time, mount the dust cap on the projector to prevent dust or dirt from getting inside.

Items to prepare

Ball point hexagon wrench driver (2.5 mm)

Mounting the lens

1. Remove the dust cap from the projector.

Push the tongue at the top left outward and pull the knob at the center of the cap.

2. Remove the lens cap on the back of the lens.

NOTE:

- Make sure to remove the lens cap at the unit back side. If the lens unit with the lens cap remaining on is installed on the projector, it may cause of malfunction.

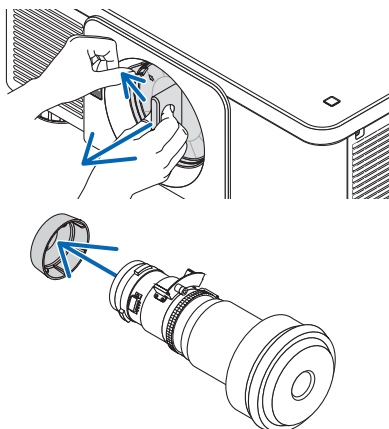

- 3. Hold the lens unit aligning the labelled arrow on the unit coming top and insert the unit to the projector.**

Insert the lens slowly all the way in, keeping the positioning slit at the same angle.

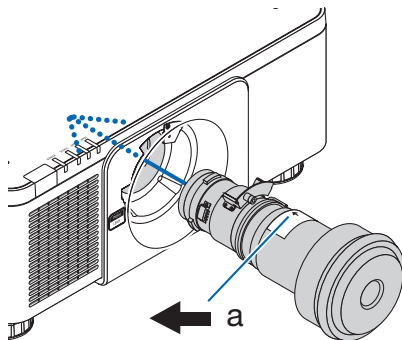

a: Arrow mark

- 4. Turn the lens unit rightward until click is heard.**

The lens is now fastened onto the projector.

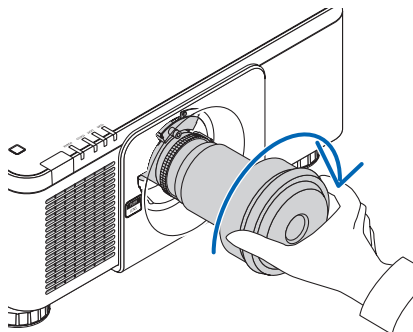

- 5. Use a ball point hexagon wrench driver to turn lens unit screw Ⓐ clockwise to tighten.**

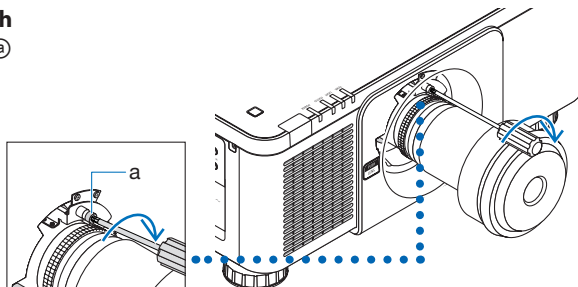

Removing the lens

Before removing the lens:

1. Turn on the projector and display an image.
2. Press the LENS CALIBRATION button.
The lens position will be moved to the home position.
3. Turn off the projector, and then unplug the power cord.
4. Mount the lens cap on the lens.
5. Wait until the projector cabinet is cool enough to handle.

1. To untighten, use a ball point hexagon wrench driver to turn the lens unit screw **a** counterclockwise until it rotates freely.

The screws cannot be removed.

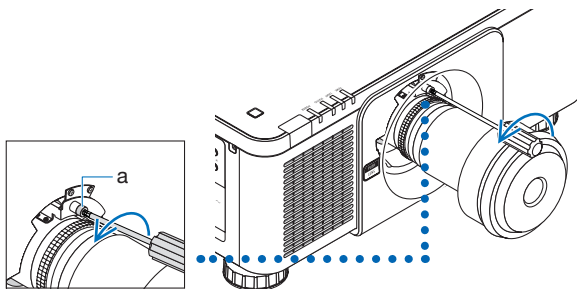

2. While pressing the LENS release button on the projector's front panel fully in, turn the lens counterclockwise.

The lens comes off.

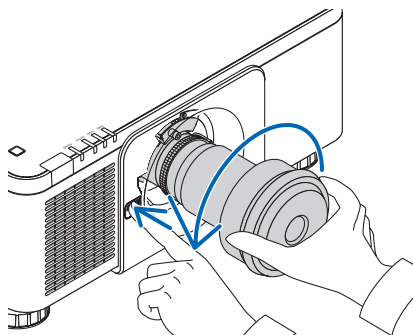

3. After slowly pulling the lens off the projector, release the LENS release button.

- After removing the lens, mount the lens caps (front and back) included with the lens before storing the lens.
- If no lens is going to be mounted on the projector, mount the dust cap included with the projector.

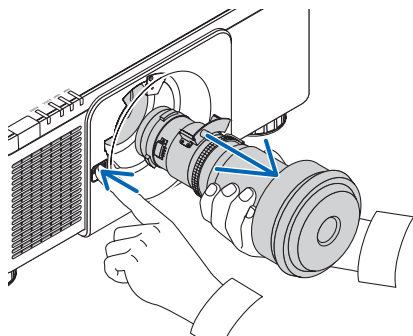

To attach the dust cap to the projector, locate the catch on the lower end of the dust cap and place it into the opening of the projector with the point of a triangle mark (▽) facing downward (① in the figure below), and then push the upper end of the dust cap against the projector to place the catches into the slot while clutching the handle (② in the figure below).

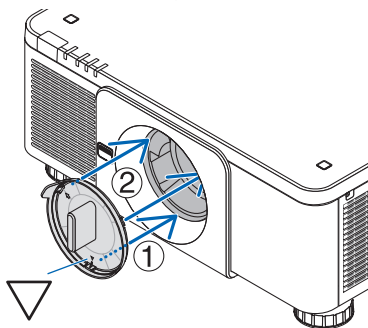

SHARP