

SHARP

EShare Wireless Casting Application

User Manual

Product:
PN-LC862
PN-LC752
PN-LC652

Table of content

	Page
1. Introduction	
1.1 Terminology	2
1.2 About EShare	3
1.3 Supported devices	3
1.4 Required network settings	4
1.5 Prepare the display	5
1.6 Using the EShare app or native standards?	6
1.7 Supported functions	6
2. EShare Server application	
2.1 Start screen of EShare Server application	7
2.2 QR-code	8
2.3 On-board User Guide	9
2.4 Webcast	10
2.5 Display Group	11
2.6 Moderator Control Center	13
2.7 Settings	17
2.8 Functions during mirroring	21
3. Native casting	
3.1 Google Cast (Chromecast) – Windows	22
3.2 Google Cast (Chromecast) – Chrome OS	23
3.3 Google Cast (Chromecast) – Android	24
3.4 AirPlay – macOS	25
3.5 AirPlay – iOS / iPadOS	26
4. Webcast	
4.1 Webcast	27
5. EShare Client Application	
5.1 Installing the EShare app	30
6. EShare Client application – Windows & macOS	
6.1 Connect	32
6.2 Functions	33
6.3 Share screen	34
6.4 Touchback enable on macOS	35
6.5 TV Mirror	37
6.6 TV Mirror functions	38
7. EShare Client Application – Android, iOS/iPadOS & ChromeOS	
7.1 Connect	39
7.2 Functions	40
7.3 Share screen	41
7.4 TV Mirror	42
7.5 TV Mirror functions	43
7.6 Remote Control	44
8. Troubleshooting	48

1. Introduction

1.1 Terminology

Term	Definition
OS	Operating System: Examples are Windows, macOS, Chrome OS.
Device	A PC or mobile device, it covers both types of devices.
PC	A personal computer, either a desktop or PC. In this case we mean all types: Windows, Chrome OS and macOS
Mobile device	A computer small enough to hold in your hand. In this case we mean mobile phones and tablets, no matter the OS version.
EShare Client	The EShare application which is installed on your personal device.
EShare Server	The EShare application which is pre-installed on the display.
Casting / Share Screen	Cast the content of the device to the display. Audio and touchback can be used without any cable. depending on the OS version which is being used.
Mirroring / TV Mirror	Mirror the content from the display to the device. Touchback can be used without any cables. Audio cannot be received from the display to your device.
Display Group / Broadcast	The large display can be duplicated on multiple other large displays in the same network simultaneously.
Webcast	Share your device with the display using the browser of your device, without having to install the EShare Client application.
Display	The Sharp interactive displays: PN-LC652, PN-LC752 & PN-LC862
Multiple Screens	Cast the content of multiple devices to a display simultaneously. The display will be split automatically, to show the different streams. Maximum 9 screens can be shown at the same time.
Remote Control	When using the EShare Client application, it is possible to gain wireless control over the display via wireless mouse, air mouse, keyboard, touchpad and remote control.

1. Introduction

1.2 About EShare

With the EShare app you can share your screen from any device (PC, smartphone or tablet) to the Sharp interactive display, and the other way around.* The display can be controlled wirelessly through your device.



1.3 Supported devices

Device type	OS	Supported version
PC	Windows	Windows 10 or later
	Chrome OS	Chrome OS ver. 92 or later
	macOS	macOS 10.15 or later
Mobile device	Android	Android 9 or later Note: Android 9 has the limitation that it will play the audio from the phone, not through the speakers of the display.
	iOS/iPadOS	iOS/iPadOS 14 or later

* a router or access point is required to set up the connection.

1. Introduction

1.4 Required network settings

In order to get the best possible user experience certain ports/protocols should be available.

The following ports are used and therefore need to be available:

EShare

- TCP Ports:
 - 56789, 25123, 8121 & 8000
- UDP Ports:
 - 48689 & 25123
- DNS:
 - H1.ee-share.com

AirPlay

- TCP Ports:
 - 51040, 51030, 51020 & 51010
- UDP Ports:
 - 5353 (mDNS to broadcast AirPlay)

General remarks for creating the best user-experience:

- The display and the devices which you want to connect need to be on the same network.
- Enable the broadcast function of the router.
- For the most stable connection it is recommended to connect the display using Ethernet and the device with 5GHz Wireless LAN band.

1. Introduction

1.5 Preparing the Display

1. Connect the display to the network.

- Wirelessly: connect the wireless adapter, which is included with display.
- Wired: insert the LAN-cable into the LAN-port

Note: see page 47 of the operation manual of the LC-series for more explanation.

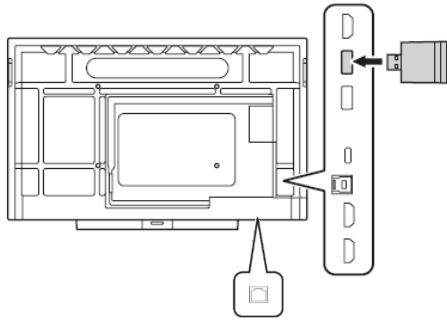

2. Set up the required network.

- Open the System Settings, go to the chapter 'Network' and activate the network you wish to use.

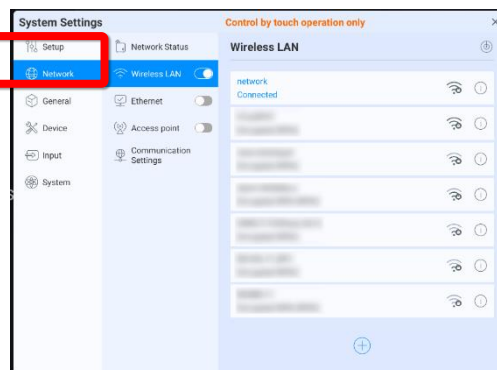

3. Open the EShareServer application from the launcher screen.

- It can happen that a pop-up window will be shown, asking for a license activation. Once you connected to the internet, the license will be register automatically and this pop-up window will not appear again.

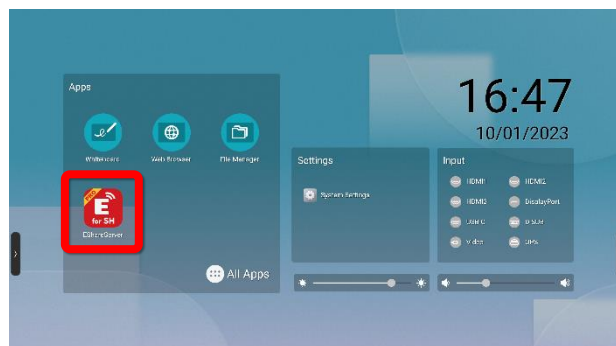

1. Introduction

1.6 Using the EShare app or native standards?

Native protocols

EShare supports a range of native OS wireless display standards, that allow you to cast your PC or mobile device's screen onto the display. This is especially easy as it will most probably be a way of connection as you are already used to.

To cast without installing the EShare application on the device, the following methods are available:

Windows	Google Cast, Webcast	Android	Google Cast
macOS	AirPlay, Webcast	iOS/iPadOS	AirPlay
Chrome OS	Google Cast, Webcast		

EShare application

Using the EShare application has some advantages over the use of the OS wireless display standards. Among other, it will allow mirroring from the display to multiple devices, and even allowing touchback on certain OS versions.

In this manual we will explain how to use the OS wireless display standards, as well as how to use the EShare application on the different type of Operating Systems. Please note that the screenshots may differ from your OS, as updates on the OS side occur frequently.

1.7 Supported functions

OS	Type	Casting	Sound	Touchback	Multiview	Mirroring
Windows	EShare app	Yes ^{*1}	Yes	Yes	Yes	Yes
	Google Cast	Yes	Yes	No	Yes ^{*2}	No
	Webcast	Yes	Yes	No	Yes	No
macOS	EShare app	Yes ^{*1}	Yes	Yes	Yes	Yes
	AirPlay	Yes ^{*1}	Yes	No	Yes	No
	Webcast	Yes	Yes	No	Yes	No
Chrome OS	EShare app	Yes	No	No	Yes	Yes
	Google Cast	Yes	Yes	No	Yes ^{*2}	No
	Webcast	Yes	Yes	No	Yes	No
iOS/ iPadOS	EShare app	Yes	Yes	No	Yes	Yes
	AirPlay	Yes	Yes	No	Yes	No
Android	EShare app	Yes	Yes ^{*3}	No	Yes	Yes
	Google Cast	Yes	Yes	No	Yes ^{*2}	No

*1 It can also be used as an extended display when casting.

*2 Google Cast is limited to one device at a time.

*3 Android 10 or later, with Android 9 or before sound will be played via phone.

2. EShare Server application

2.1 Start screen of EShare Server application

Once you opened the EShare Server application, the following window will appear:



1. Network information
Note: when using Wireless LAN, the name of the network is showed here. When the display is connected to a LAN, the name of the network will not be shown due to limitations of LAN.
2. Floating Bar
3. Device Name
4. IP-address
5. URL for downloading the EShare Client application.
6. QR-code
7. Webcast information
Note: only when the Webcast function is activated, this information will be shown here.
8. On-board User Guide
9. Webcast settings
10. Display Group settings
11. Moderator Control Center
12. Settings

2. EShare Server application

2.2 QR-code

The QR-code has 2 functions:

- When scanned with the camera of your mobile device it will direct you to the EShare Client Application download website, where you can download the correct EShare Client application.
- When scanned with the camera while being in the EShare Client application it will connect your mobile device to the display, without having to fill in the required information to connect to the display manually.

1. Click on the QR-code on the start screen.

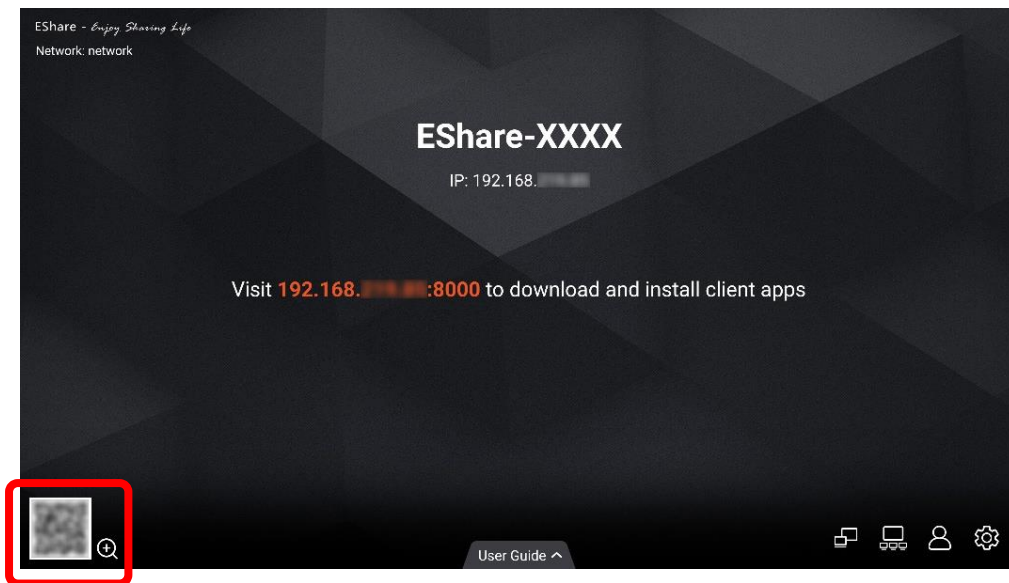

2. Scan the QR-code with your mobile device.

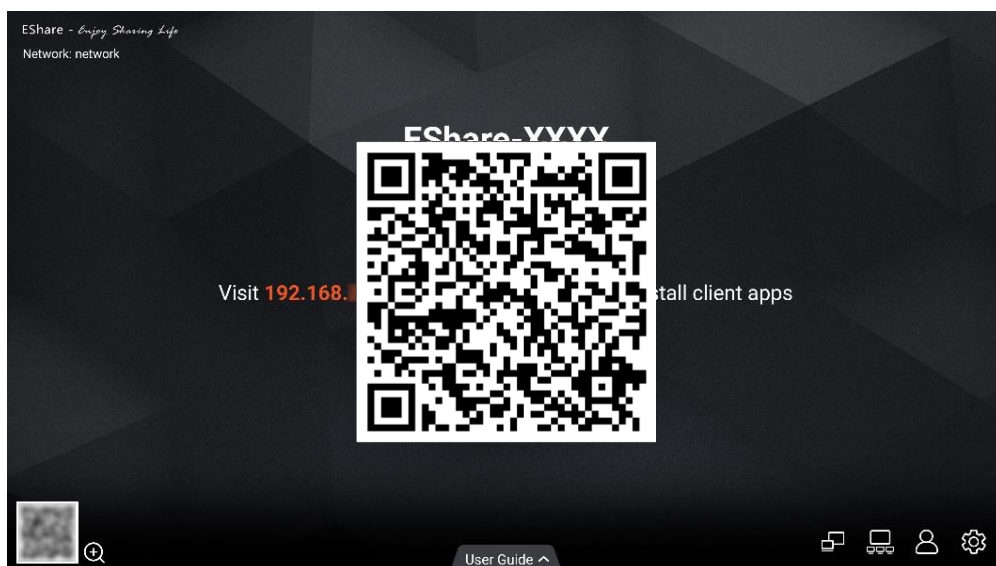

3. Download the EShare Client application (see page 29) or connect your device (see page 36).

2. EShare Server application

2.3 On-board User Guide

There is a user manual within the EShare Server app. This makes it easier for new users to learn how to connect with the display. Once you open the EShare application it is just one click away.

1. Click on the User Guide icon on the start screen.

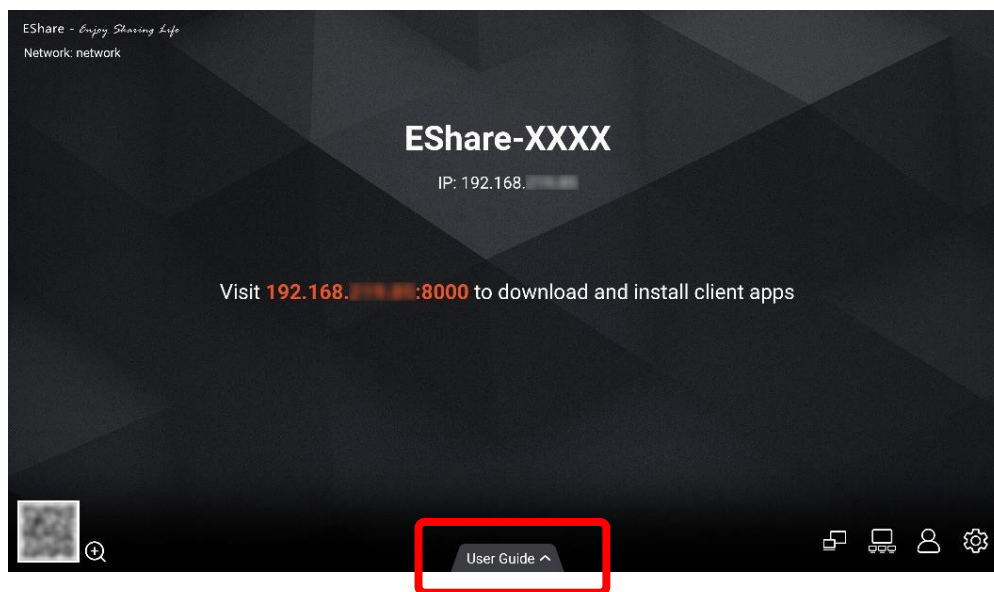

2. Follow the steps from left to right:

1. Install the app on your device or scan the QR-code using your mobile device,
 - If you use the native protocol of your own device, or you already installed the EShare Client application you do not need to take this step anymore.
2. Make sure the device is in the same network as the display,
3. Select the display you want to connect to by searching for it on your device
 - How this is done depends on your OS version. For this see chapters 5 and 6.



2. EShare Server application

2.4 Webcast

It is possible to cast to the display by using the web browser of your PC. This does not require any of the native OS wireless display standards or the EShare Client application.

Please note that Webcast requires an active internet connection on both devices and will only work if both devices are in the same network.

On this page we will explain the steps which need to be taken on the display side. On page 27 you will find the steps which need to be taken on the PC side.

1. Open the EShare Server application on the display.
2. Click on the Webcast icon.

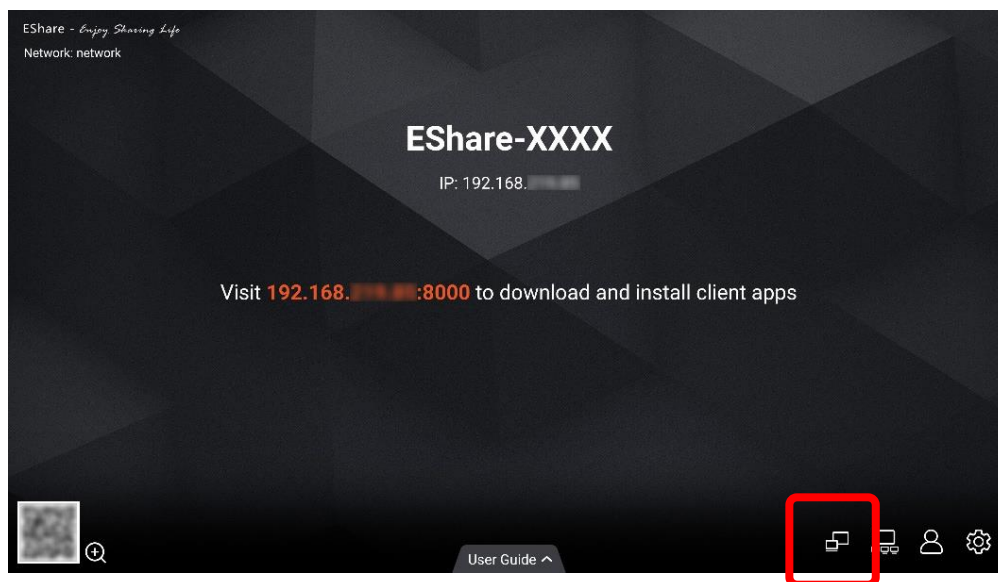

3. Enable Webcast.

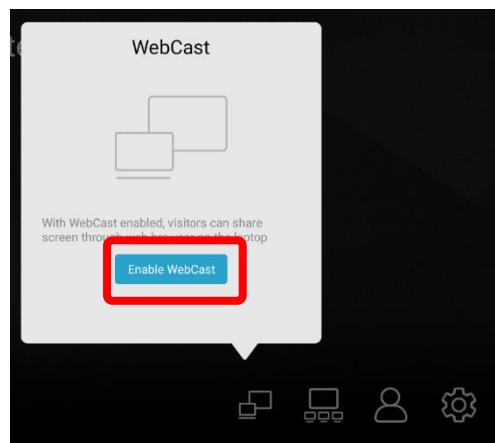

4. See page 27 for the steps which need to be done on the PC in order to start Webcast.

2. EShare Server application

2.5 Display Group

The group functions allows you to (broad)cast content from one display to multiple other displays, which are in the same network.

Please note the function will (broad)cast image only, sound or touch are not supported.

1. Click on the Display Group icon.

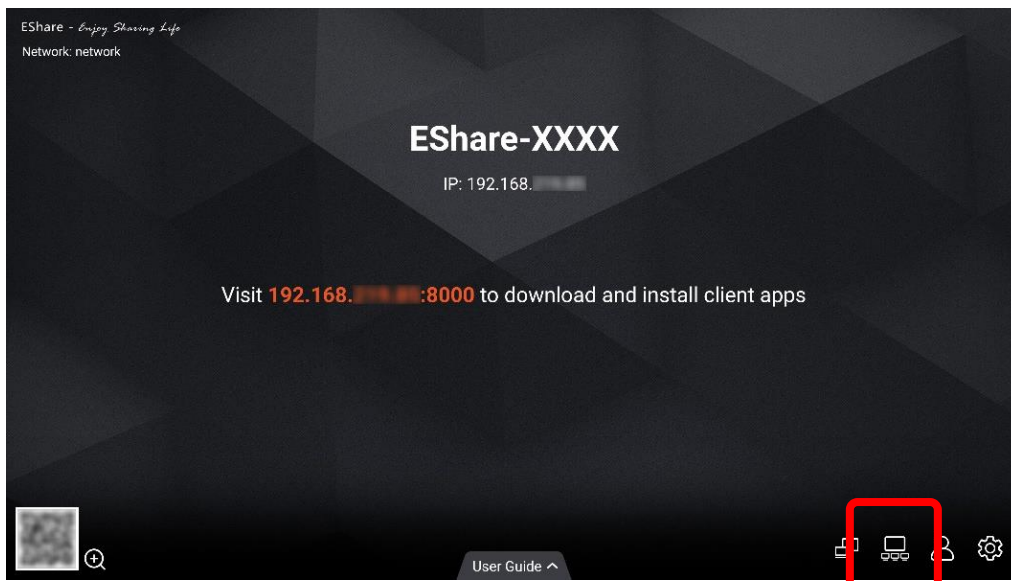

2. Select the displays you want to create a group with manually or check the "Select All" box to select all the available displays at once.

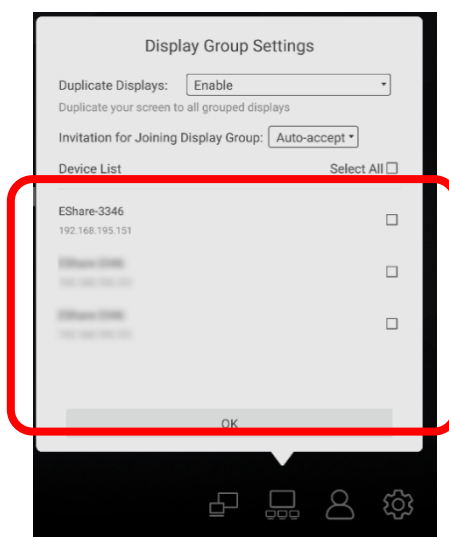

3. Click on the OK button to start (broad)casting.

2. EShare Server application

2.5 Display Group

There are 2 options which can be set in the Display Group Settings Menu. These options are:

1. Duplicate Displays:

- **Enable** = the function is enabled, allowing you to (broad)cast to multiple displays simultaneously. You will see a list of available displays to cast to.
- **Only valid in client screen sharing** = Only devices which have the EShare Client application installed will be able to (broad)cast.
- **Disable** = the function will be disabled. No displays will be shown, even though they are in the same network.

2. Invitation for Joining Display Group.

- **Auto-accept** = other displays can start (broad)casting their device to this display without permission.
- **Notify me** = a pop-up window (see image 3) will appear which allows the presenter to accept or deny the request to receive the (broad)cast.
- **Disable** = all Display Group invitation will be automatically rejected.

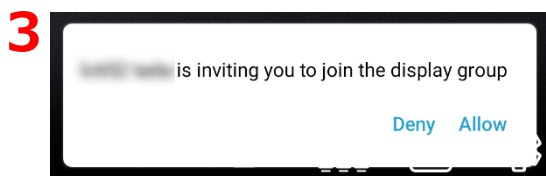
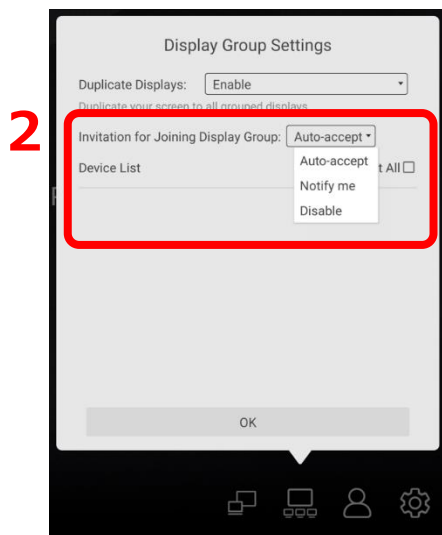
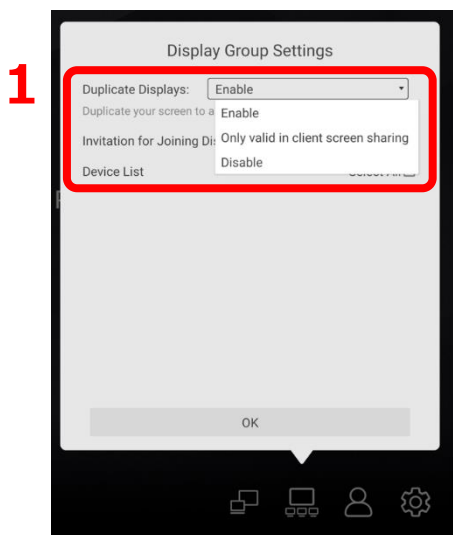

2. EShare Server application

2.6 Moderator Control Center

In the Moderator Control Center, the presenter can set a range of settings allowing to get more control over the display while using EShare, in order to have no unintended or unexpected casting from device to the display.

1. Click on the Moderator Control Center icon to open the menu.

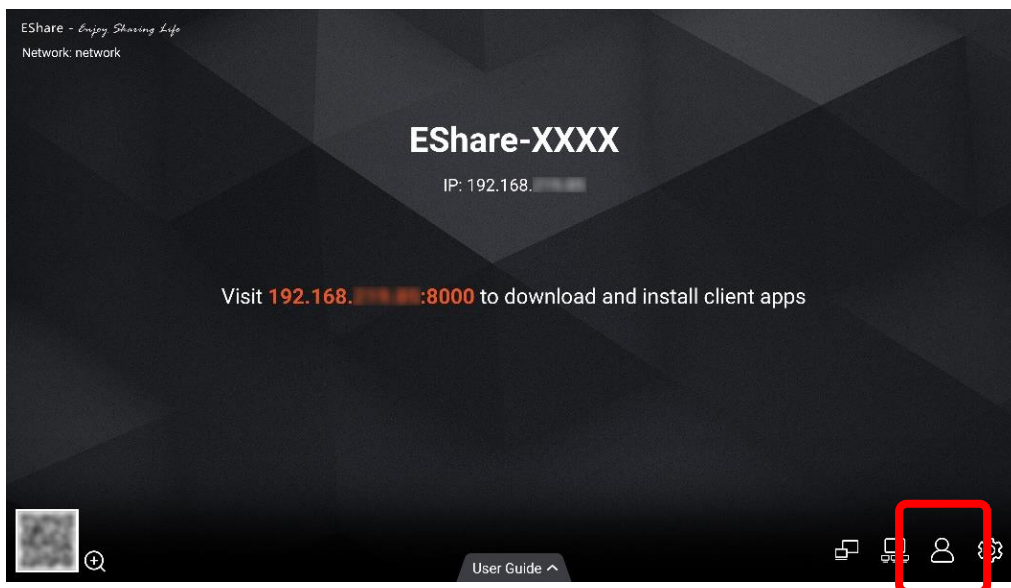

2. The Moderator Control Center has many functions, which will be explained on the next pages.



2. EShare Server application

2.6 Moderator Control Center



1. Share Screen of File

- **All allowed** = devices can cast their screen or share images/audio/videos/files to the display. The EShare Client application for iOS or Android also allows sharing the camera to the display in real-time.
- **Need authorization** = the button "Allow" in the pop-up windows on the display needs to be pressed first, before the Client is allowed to start sharing.

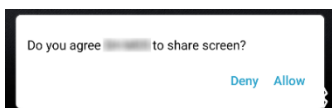

- **Disable** = the function is disabled; it is not possible to cast to the display at all.

2. View, Control and Wireless Annotation

- **All allowed** = all devices are allowed to View (receive the content from the display on your own personal device), Control (control the display by using wireless touch) and Wireless Annotation (make virtual annotations on the content on the display).
- **View only** = only receiving the image of the display on your own personal device is allowed. Both Control and Wireless Annotation are not allowed.
- **Need authorization** = the button "Allow" in the pop-up windows on the display needs to be pressed first, before the Client is allowed to get full control.

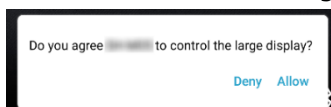

- **Disable** = the function is disabled; it is not possible to receive content from the display at all.

2. EShare Server application

2.6 Moderator Control Center



3. Floating Moderator Button

- **Always displayed** = the floating button to access the Moderator Control Center will always be visible. Even when using another application or when working on other sources
- **Only on the Home Screen** = the floating button will only be visible on the start screen of the display itself. The button will not be visible when presenting, using other applications or when working on other sources.
- **Disable** = the function is disabled; the floating button will not be visible anywhere.
- **Auto** = the floating button will appear only when a device is connected.

4. Type of connected devices



- The icon will show the type of device (PC or mobile phone) and OS (Microsoft, Apple or Chrome) is being used. This is for easy recognition while looking for a specific device or user.

2. EShare Server application



2.6 Moderator Control Center



5. Give permission to control the display

-  = the device is not allowed to control the display. Click to allow control.
-  = the device is allowed to control the display. Click to prevent control.

6. Bring a device to the display

-  = the connected device is currently not casting. Click to start casting.
-  = the device is currently casting. Click to stop casting.

7. Disconnect a device from the session

-  = disconnect a device from the session.

8. Number of connected devices

- Here you can find the total number of connected devices. The total number of connected devices in the same session depend on the network, router and bandwidth.

Note: the performance is depending on your own network.

2. EShare Server application

2.7 Settings

In the Moderator Control Center, the presenter can set a range of settings allowing to get more control over the display while using EShare. All is developed to have no unintended or unexpected mirroring.

1. Click on the Settings icon to open the Settings Menu.

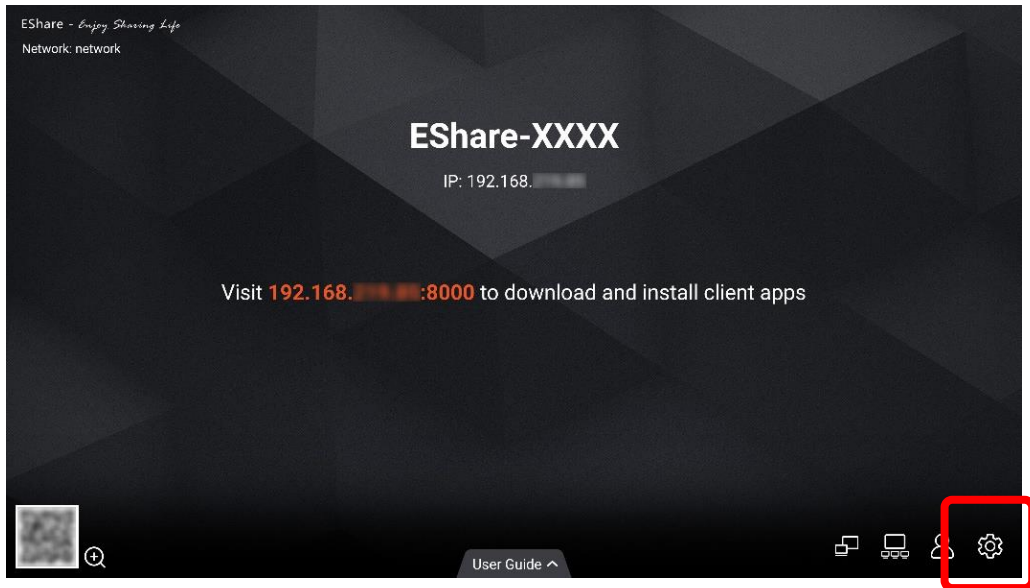

2. The Settings menu has many functions, which will be explained on the next pages.
Note: depending on the selected settings (Password or PIN code), the lay-out can be different. The image below shows the default setting.

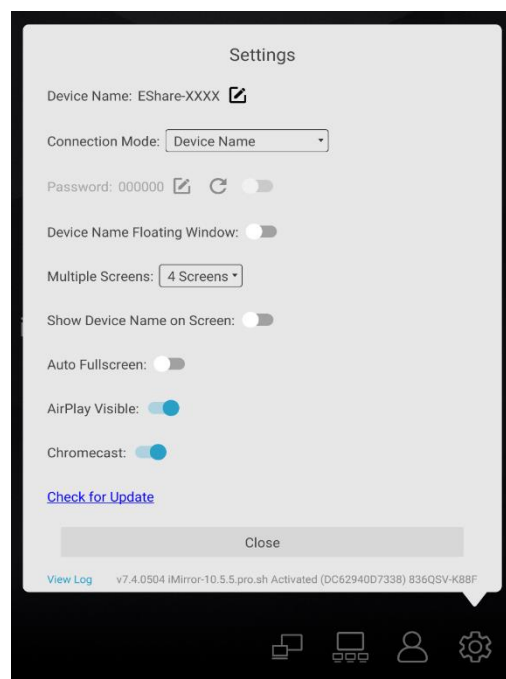

2. EShare Server application

2.7 Settings

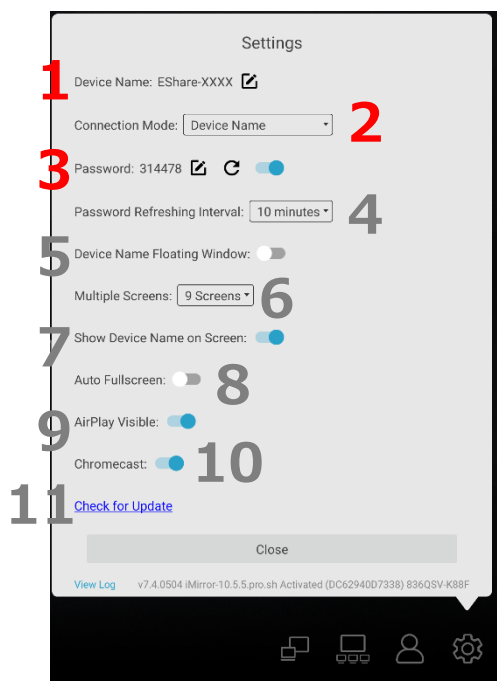



1. Device Name

- Click on the  icon to customize the device name. This name will be visible for everybody when searching for the display in the network.

2. Connection Mode

- **Device Name** = if device name is chosen, you just need to select the name of the screen you want to use in the list of displays to connect.
- **PIN Code (6 digits)** = fill in the 6 digits PIN code on your device, which is shown on the screen, to start casting.
- **PIN Code (8 characters)** = fill in the 8 PIN Code on your device, which is shown on the screen, to start casting.

3. Password / PIN code

- Screen sharing can be protected by a PIN code or Password (see number 2 in this chapter). To set one of the two options, select the desired one from the pull-down menu at "Connection Mode". A PIN code or Password is generated automatically.
 -  = When the connection Mode is "Device Name", you can enable/disable the password.
 -  = customize the Password by clicking on the icon. PIN cannot be changed.
 -  = refresh the PIN code or Password manually.

Note: Chromecast does not support a PIN code, therefore it will start casting immediately.

2. EShare Server application

2.7 Settings

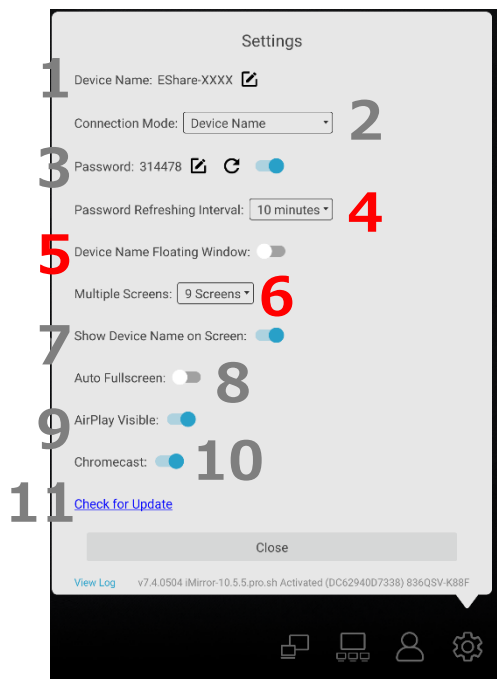

4. Refreshing Interval

- The PIN code or Password can be refreshed automatically. The intervals which can be chosen are; fixed, 10minutes , 30minuntes, 1hour or 1day. Default setting is 10 min.

5. Floating Window

- Within this Floating Window you will find the Device Name or PIN code, depending on your choice at number 3. Please see page 7, number 2, for the visual.
- The Floating Window is turned off by default. You can have different preferences per connection mode. E.g., on with PIN code and off with choosing device name.
- The Floating Window can be moved from left to right on the top side of the display.
- It will be visible on all sources, for connecting easily without having to switch input.
- By clicking on the Floating Window, you can open the EShare Server Settings.

6. Multiple Screens

- EShare can show up to 9 devices at the same time. The display will be split automatically, depending on the number and type of devices.

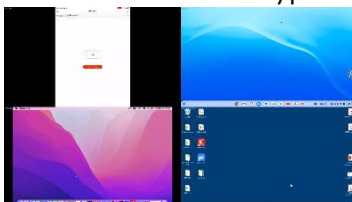



- Multiview is supported for different types of OS. Multiple streams of Chromecast are not supported as this protocol support full screen mode only.

2. EShare Server application

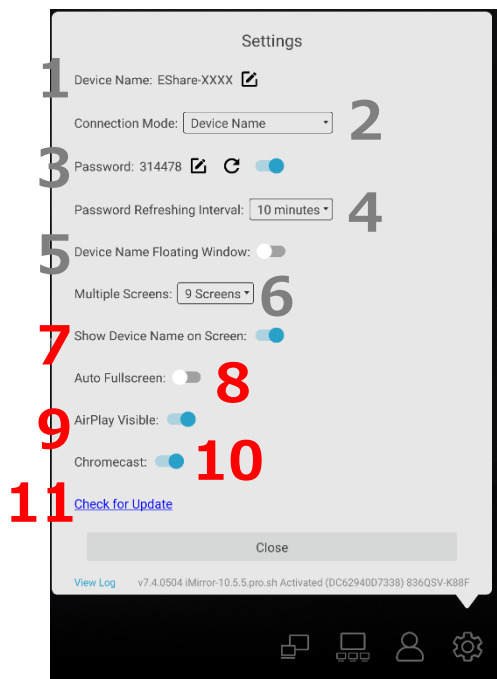

2.7 Settings





7. Show device Name on Screen

-  = the name of the device which is casting will not be visible on the display.
-  = the name of the device which is casting will be visible on the display.



8. Auto Fullscreen

-  = a connected device will not be shown full-screen when casting but will be shown according the size which is set in the option "Multiple Screens".
-  = a connected device will be shown full screen when casting.

9. AirPlay Visible

-  = the display will not be visible for AirPlay users.
-  = the display will be visible for AirPlay users.

10. Chromecast

-  = the display will not be visible for Chromecast users.
-  = the display will be visible for Chromecast users.

11. Check for Updates

- EShare will check if there are updates available. If an update is available, you can download and install it.

2. EShare Server application

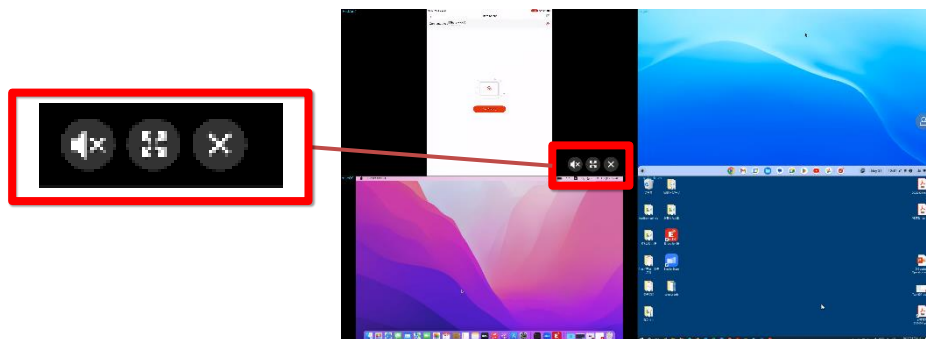

2.8 Functions during mirroring

When devices are casting to the display, there will be several control options which can be used on the display side. Simply touch the window you want to control, and the buttons will appear.





The buttons come in pairs, once you click on the button the image will change. Please find the explanation of the buttons below.

1. Control the size of the stream

-  = when multiple screens are being casted simultaneously, touching the icon will show the selected screen in full-screen mode.
-  = exit full-screen mode. EShare will go back to the multiple screen overview.



2. Control the volume of the stream

-  = the audio of the device is played from the display. Touch to mute the audio.
-  = the audio is muted. Touch to play the audio.

Note 1: Only one device can stream audio to the display, the other devices are muted.

Note 2: When using the EShare Client app on Chrome OS and when using Android 9, audio is not played from the display, but from the device.

3. Control the touch permission

-  = touchback is currently enabled. Click to disable touchback.
-  = touchback is currently disabled. Click to enable touchback.

Note: Touchback is only available for Windows & macOS with EShare app.

4. Stop casting

-  = stop casting.

3. Native casting

3.1 Google Cast (Chromecast)

Windows

Chrome OS

Android

1. Open the Google Chrome browser on your PC.
2. Open the Settings in the Google Chrome Browser.

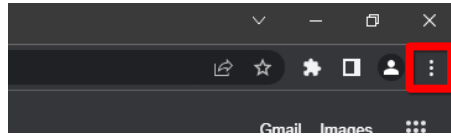

3. Select Cast from the Google Chrome browser menu.

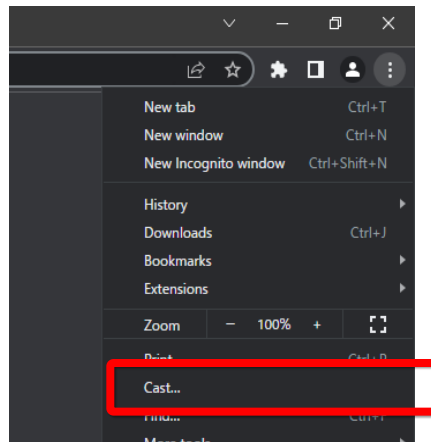

4. Select the screen you wish to cast to.

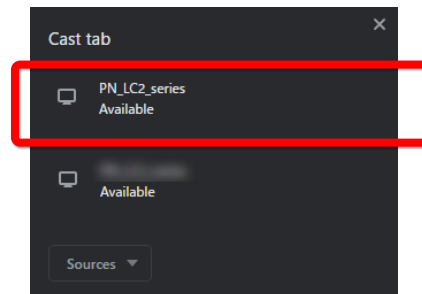

5. Select what you want to mirror: "Tab" or "Screen".
 - Tab is one selected window only; Screen will cast the complete desktop.

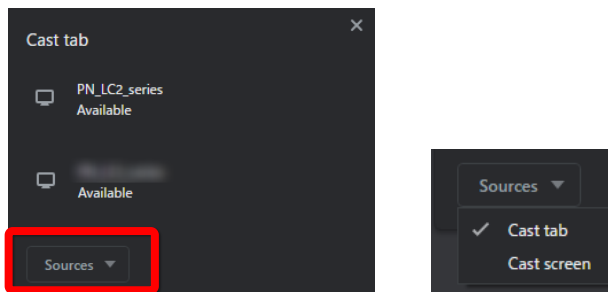

6. Once you made the choice, you can click on the selected device to start casting.
7. To stop casting, simply use the same steps as above and click on "stop casting".

3. Native casting

3.2 Google Cast (Chromecast)

Windows

Chrome OS

Android

1. Open the Quick Settings panel at the right corner of your device.
2. Select "Cast".

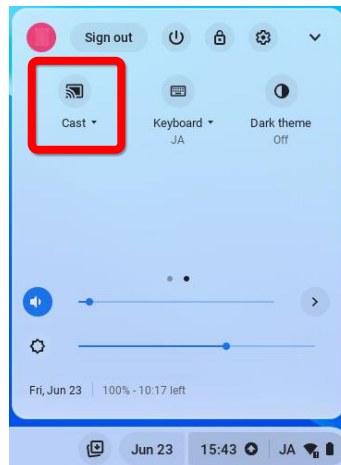

3. Click on the name of your device you wish to connect with.

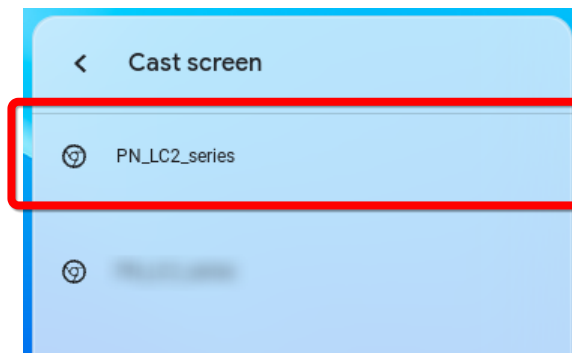

1. Once you made the choice, you can click on the selected device to start casting.
2. To stop casting, click "Stop" in the notification area.

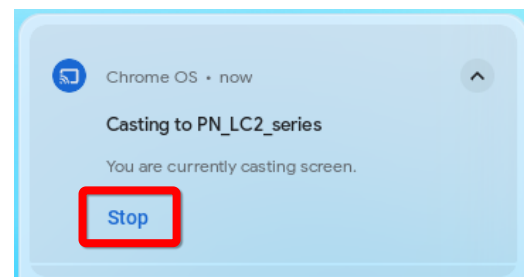
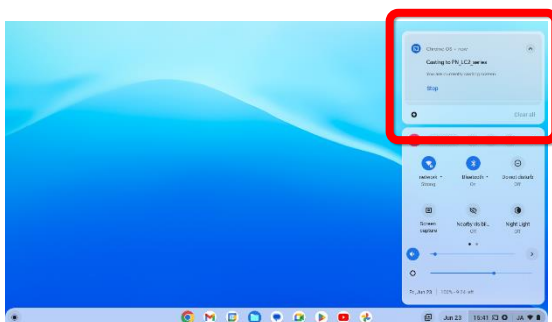

3. Native casting

3.3 Google Cast (Chromecast)

Windows

Chrome OS

Android

1. Open the Quick Settings panel in the lower right corner of your device
2. Select "Cast".

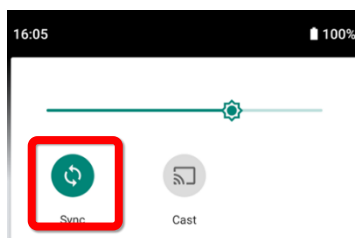

3. Click on the name of the device you wish to connect with.

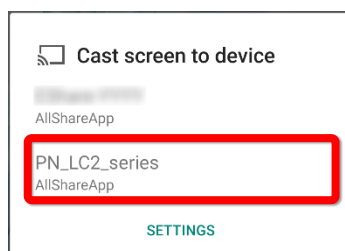

4. Once you made the choice, you can click on the selected device to start casting.
5. To stop casting, simply use the same steps as above and click on "stop casting".

3. Native casting

3.4 AirPlay

macOS

iOS/iPadOS

1. Open the Control Center, which can be found in the Menu Bar of your Mac.
2. Select "Screen Mirroring"

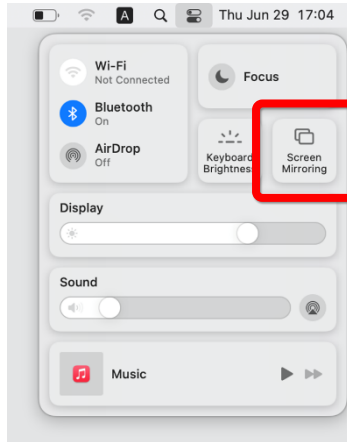

3. Click on the name of the device you wish to connect with.

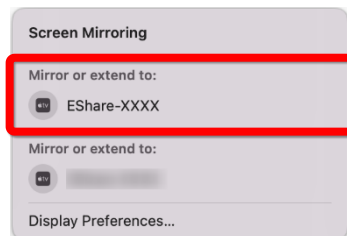

4. Once you made the choice, click on the selected device to start casting immediately.
5. Select how you want to cast: mirror the display or as an external monitor.



6. To stop casting, Click on the name of the connected display.

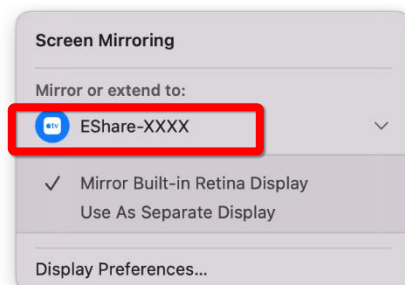

3. Native casting

3.5 AirPlay

macOS

iOS/iPadOS

1. Open the Control Center by swiping from the bottom to the top, or by swiping from the top right corner down, of your iPad.
2. Select the Screen Mirroring icon.

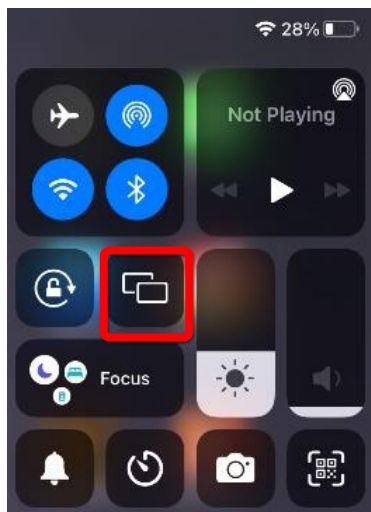

3. Click on the name of the device you wish to connect with.

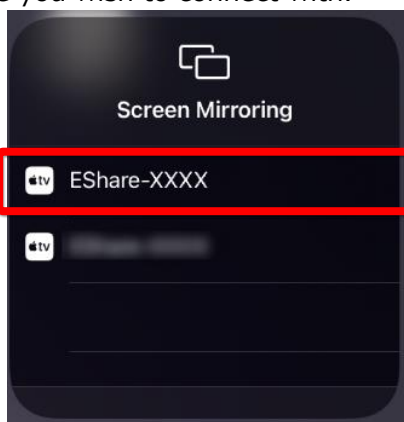

4. Once you clicked on the device from the list, screen casting will start immediately.
5. To stop casting, simply use the same steps as above and click on "Stop Mirroring".

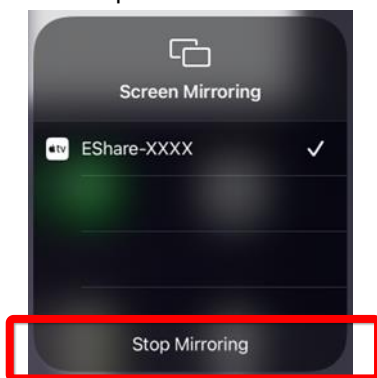

3. Native casting

3.6 Webcast

Windows

Chrome OS

macOS

Action to be taken on the PC

Please make sure the Webcast function is activated in the EShare Client application. Please see page 10 for more information about this topic. If the Webcast function is turned on, the following steps need to be done on your PC side to start casting.

1. Open the browser* on the PC
 - * The following browsers are supported:
 - Windows: Google Chrome, Edge
 - macOS: Safari
 - Google Chrome OS: Google Chrome

2. Enter the following website in the search bar: *casts.app*



3. Enter the Webcast ID which is shown on the display.



4. Enter the one-time password, which is shown on the display.

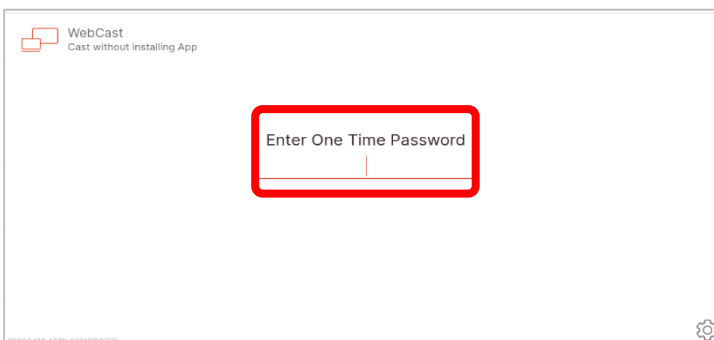

4. Webcast

4.1 Webcast

Windows

Chrome OS

macOS

Action to be taken on the PC

5. Select what you want to cast: "Tab" or "Desktop".
 - **Tab** = one selected tab from your browser.
 - **Window** = the program which you are using.
 - **Entire Screen** = cast everything you have shown on your own PC, even after changing windows/program.

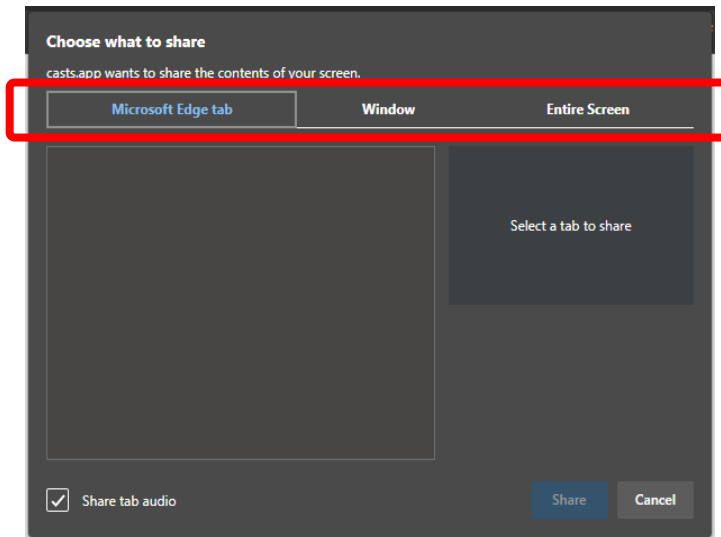

6. Click on Share to start casting.

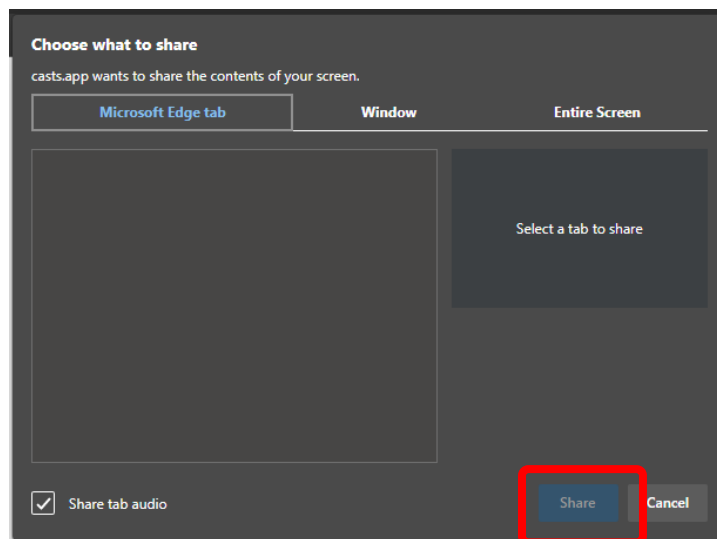

4. Webcast

4.1 Webcast

Windows

Chrome OS

macOS

Action to be taken on the PC

7. Once your device started casting to the display, the following window is shown.
 - The following functions can be used (from left to right)
 - Pause casting
 - Stop casting
 - Mute/unmute the sound

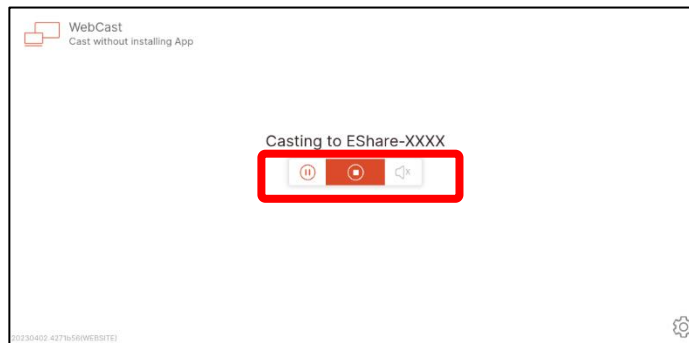

5. EShare Client application

5.1 Installing the EShare app

By installing the EShare Client application, you will be able to use all the functions EShare has to offer. There are 2 different ways to install the EShare Client application.

1. Click on the User Guide icon on the start screen.

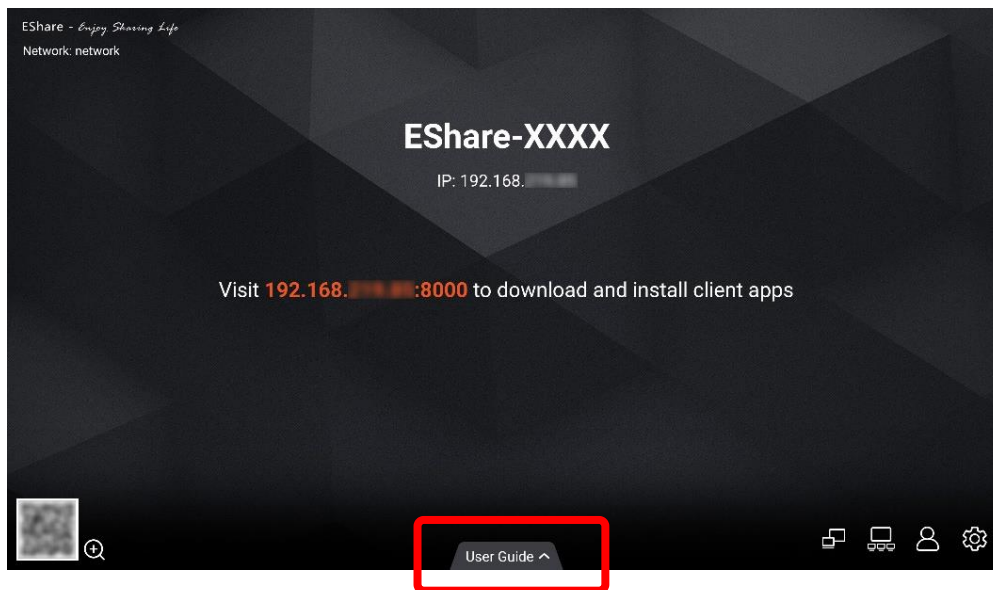

2. Visit the website of scan the QR-code.
 1. **Visit the website** = simply type in the URL in the browser on your device
 2. **Scan the QR-code** = scan it with the camera of your mobile device.

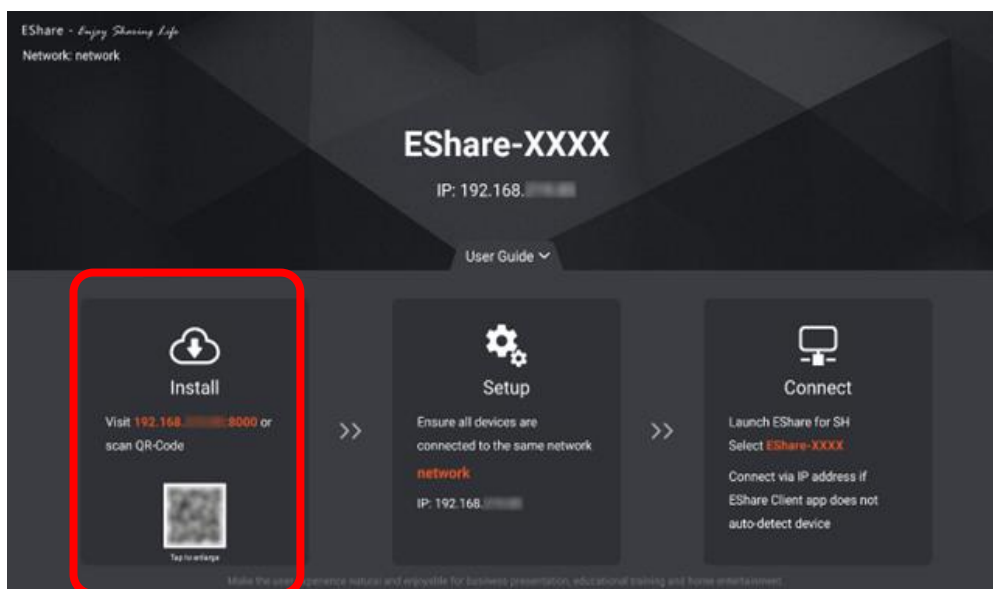

5. EShare Client application

5.1 Installing the EShare app

3. Select the version which match the OS of your device from the list.

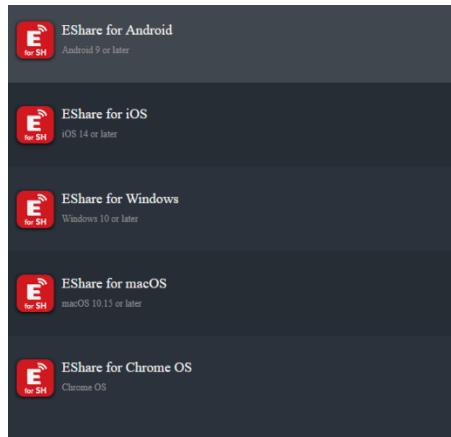

Note: some devices will direct you to the store of the device automatically. Then you do not need to do the above-mentioned action, you can then just install the application which appears.

4. Follow the steps which are mentioned on your device to finish the installation of the EShare Client application.

6. EShare Client application – Windows & macOS

6.1 Connect

Windows

macOS

1. Open the EShare Client application on your PC.



2. The EShare application will open with the following window.

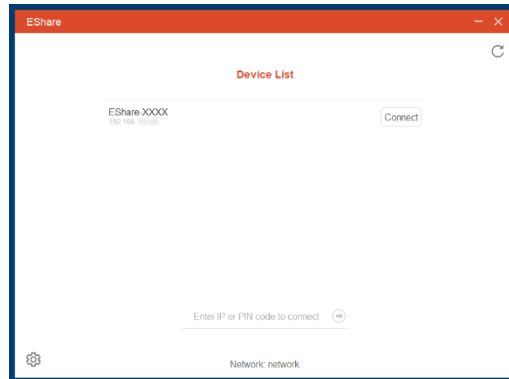

3. Select the display you want to connect with.

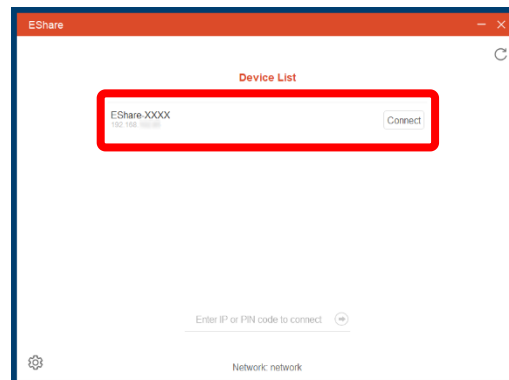

4. If the display is set to ask for a PIN or password, please fill it in there.

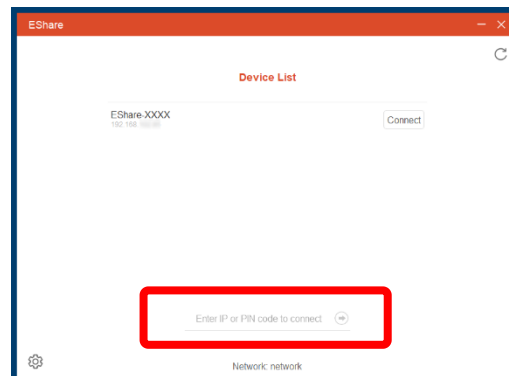

6. EShare Client application – Windows & macOS

6.2 Functions

Windows

macOS



1. **Info:** shows the information of the connected display.
2. **Shortcut:** once you connected to a display, click on the shortcut button to create a shortcut for that specific display. The shortcut will be named similar as the display name and will be placed on your desktop. **Note:** Windows only.
3. **Disconnect:** disconnect your device from sharing to the display.
4. **Share Screen:** start casting the content of your device to the display.
5. **Source:** click the pull-down menu to choose between casting the full screen of your device or extend the device. **Note:** Windows only.
6. **TV Mirror:** start mirroring the content of the display on your device.
7. **Settings:** change the application settings.
8. **Transfer:** transfer files from your device to the display for viewing.
9. **Volume:** control the volume of the casted signal.

6. EShare Client application – Windows & macOS

6.3 Share screen

Windows

macOS

Once your device started casting to the display, the icons in the EShare Client application change slightly. Below we mentioned the changes in comparison with the previous window.

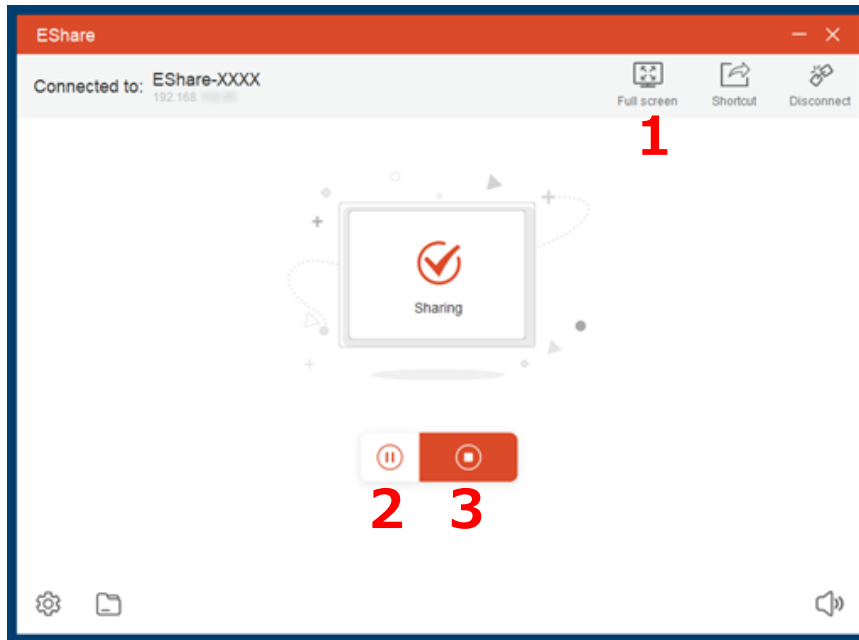

- 1. Full Screen:** shows the content on your device in full-screen on the display.
- 2. Pause:** pause sharing
 - Your device will stay connected with the display, but the content will be frozen. This mode is ideal for when you want to look something up which is not meant for the audience.
- 3. Stop:** stop sharing.

6. EShare Client application – Windows & macOS

6.4 Touchback enable on macOS

macOS

To enable touchback on macOS, you need to take the following steps once.

1. Open System Preferences on your Apple device.



2. Click on Security & Privacy

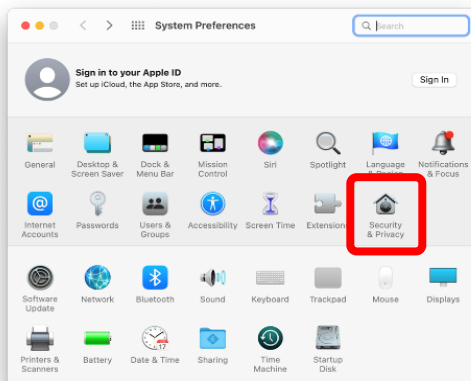

3. Click on Privacy tab

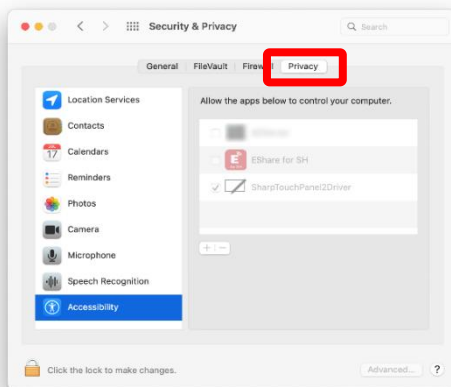

4. Click on Accessibility

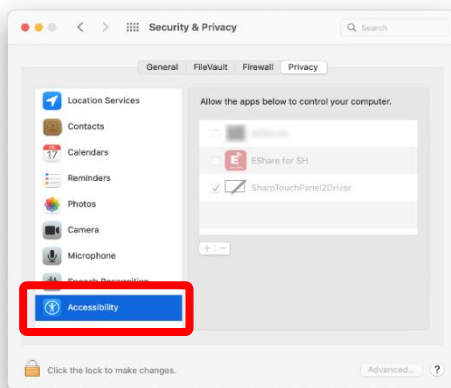

6. EShare Client application – Windows & macOS

6.4 Touchback enable on macOS

macOS

5. Click on the key icon in the lower left corner, to unlock the settings.

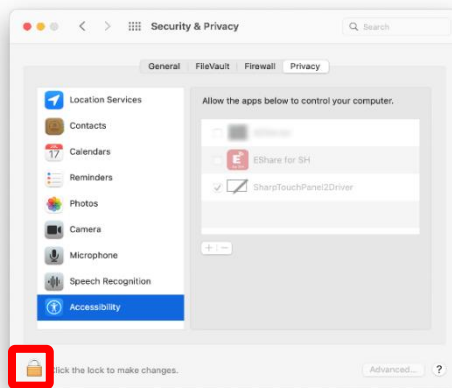

6. A pop-up window will appear. Enter the user password of your PC and click on Unlock.

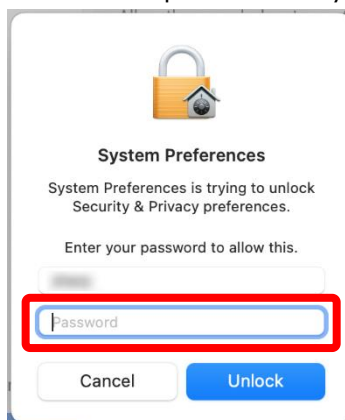

7. Select the tick box of EShare for SH, this will grant touch back permission.

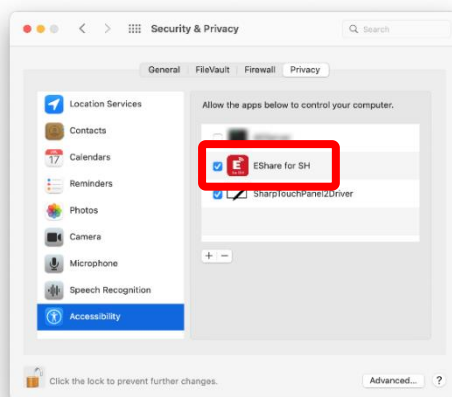

8. Click on the key icon in the lower left corner (step 5) again to lock the settings.

6. EShare Client application – Windows & macOS

6.5 TV Mirror

Windows

macOS

To receive the content of the display on your device, you can use TV Mirror. During mirroring you have the option to control the display and make annotations. To do this, please follow these steps.

1. Open the EShare Client application on your PC.



2. Click on TV Mirror.

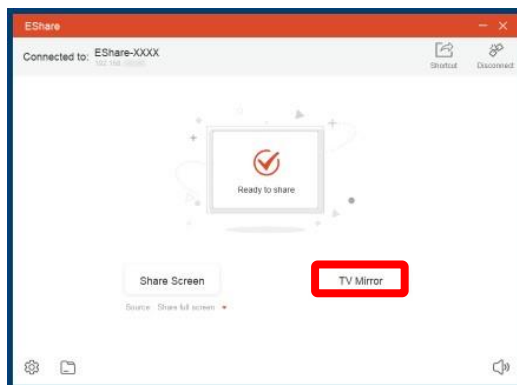

3. Click on the icon on the right side, to open the TV Mirror menu.



4. The TV Mirror menu will open. The options are:

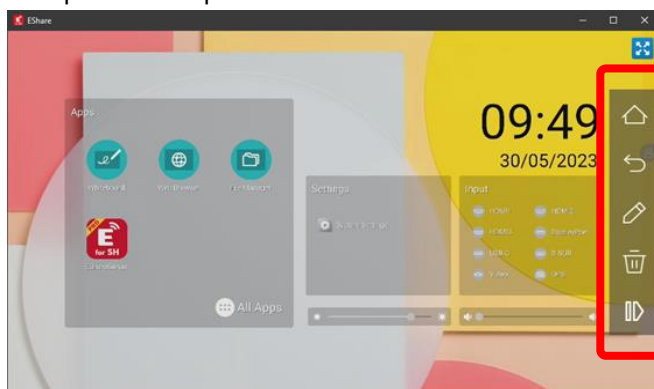

6. EShare Client application – Windows & macOS

6.6 TV Mirror functions

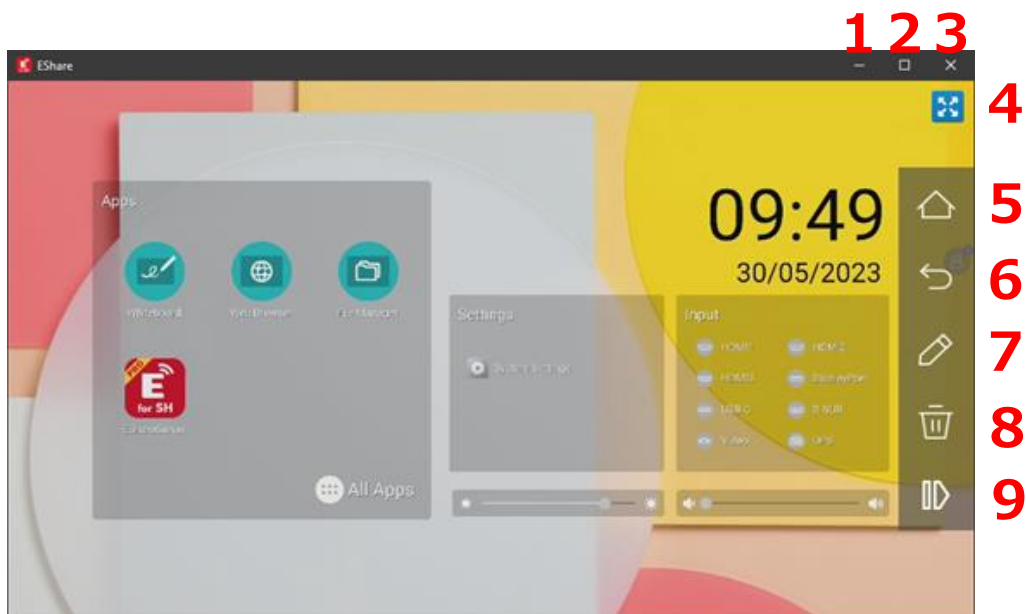

1. **Minimize:** minimize the windows of the EShare Client application.
2. **Resize:** make the window of the EShare Client application smaller or bigger.
3. **Close:** close the TV Mirror function.
4. **Full screen:** set the window of the EShare Client application in full-screen mode.
5. **Home:** when clicking on this button, the display show the home page. This is the application source by default.
6. **Back:** go back one step.
7. **Annotate:** start annotating.
Note: The annotations will be visible on the display, as well as on all the devices which receive the content from the display.
8. **Delete:** delete the annotations.
9. **Close:** close the tool menu.

7. EShare Client application – Android, iOS/iPadOS & Chrome OS

7.1 Connect

iOS/iPadOS

Android

Chrome OS

1. Open the EShare Client application on your mobile device.



2. The EShare application will open with the following window.



3. Select the display you want to connect with.
 - If the display is set to ask for a PIN code or password, please fill it in there too.



4. Tap here to connect by scanning the QR code on the display with the camera of your mobile device.

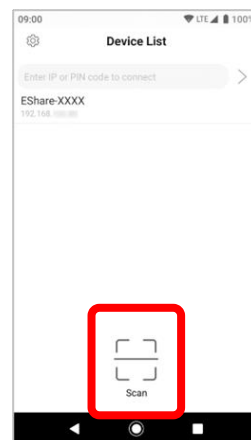

7. EShare Client application – Android, iOS/iPadOS & Chrome OS

7.2 Functions

iOS/iPadOS

Android

Chrome OS



1. **Settings:** open the Settings Menu of the EShare Client application
2. **Information:** shows the information of the connected display.
3. **Disconnect:** disconnect your device from sharing to the display.
4. **Share screen:** start casting the content of your device to the display.
5. **TV Mirror:** start mirroring the content of the display on your device.
6. **Photo:** search for a photo on your device to cast it to the display.
7. **Audio/Video:** search for audio or video on the library of your device to cast it to the display.
8. **Document:** search for a file on your device to cast it to the display.
9. **Camera:** use the camera of your device to cast video in real time.
10. **Remote Control:** use the Remote Control function. See chapter 7.6 for more information.
Note: this function does not available on Chrome OS

7. EShare Client application – Android, iOS/iPadOS & Chrome OS

7.3 Share screen

iOS/iPadOS

Android

Chrome OS

Once your device started casting to the display, the icons in the EShare Client application change slightly. Below we mentioned the changes in comparison with the previous window.

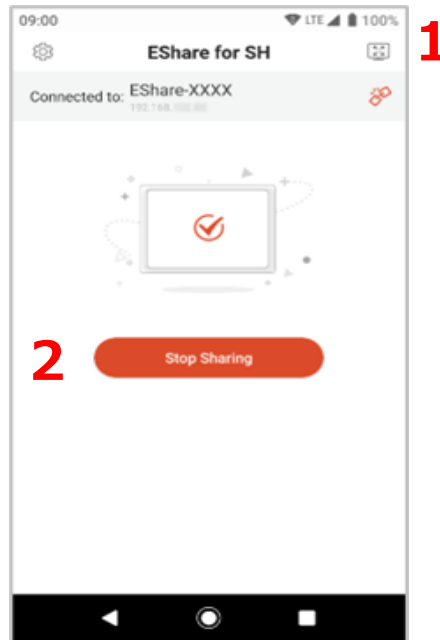

1. **Full Screen:** shows the content of your device in full screen on the display.

2. **Stop:** stop sharing.

Note: When using the EShare Client application on Chrome OS, the "Stop" button on the Chrome OS notification bar will not work properly. Please use the "Stop" button of the EShare Client application instead.

7. EShare Client application – Android, iOS/iPadOS & Chrome OS

7.4 TV Mirror

iOS/iPadOS

Android

Chrome OS

To receive the content of the display on your device, you can use TV Mirror. During mirroring you have the option to control the display and make annotations. To do this, please follow these steps.

1. Open the EShare Client application on your mobile device.



2. Click on TV Mirror.



3. Click on the icon on the right side, to open the TV Mirror menu.

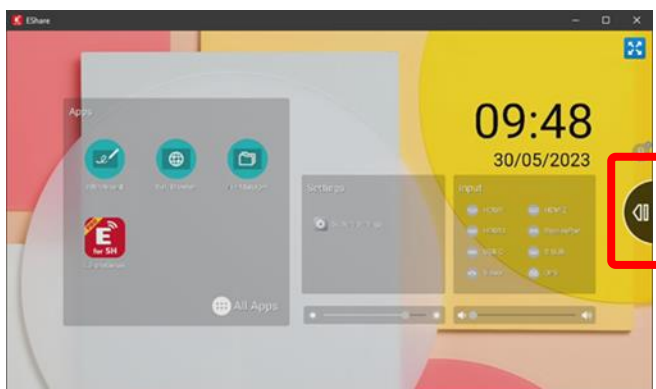

4. The TV Mirror menu will open. The options are:

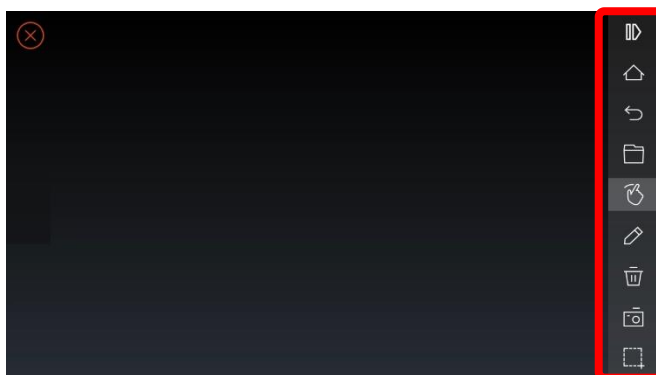

7.5 TV Mirror functions

iOS/iPadOS

Android

Chrome OS

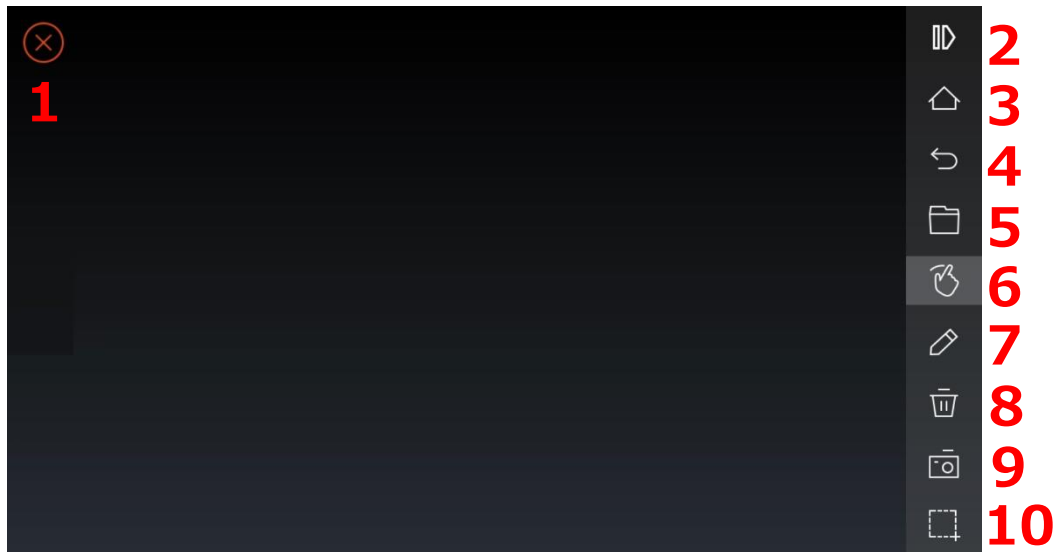

1. **Close:** close the TV Mirror function.
2. **Close:** close the tool menu.
3. **Home:** when clicking on this button, the display show the home page. This is the application source by default.
4. **Back:** go back one step.
5. **File:** search for a file on your device to cast it to the display.
6. **Touch:** control the display by using the touch of your device.
7. **Annotation:** start annotating.
Note: The annotations will be visible on the display, as well as on all the devices which receive the content from the display.
8. **Delete:** delete the annotations.
9. **Camera:** use the camera of your device to mirror video in real time.
10. **Screenshot:** take a screenshot.

7.6 Remote Control

iOS/iPadOS

Android

The EShare Client application for mobile devices has the possibility to use your device as a remote control. In other to use this function, please follow the following steps.

1. Click on Remote.

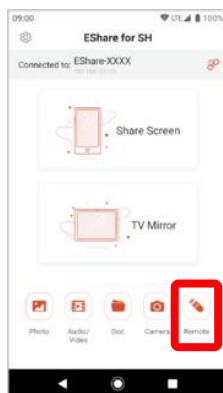

2. The Remote Control screen appears. Details are explained on the following pages.

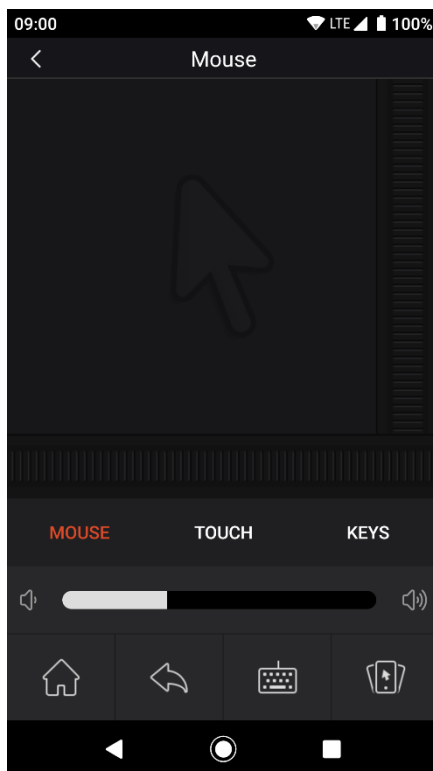

7.6 Remote Control

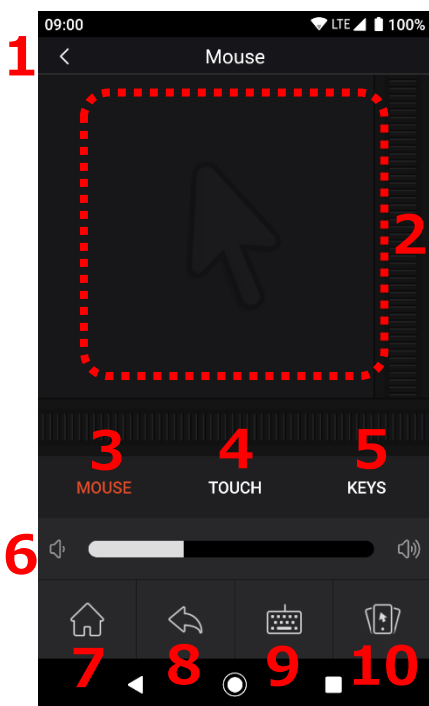

Mouse mode

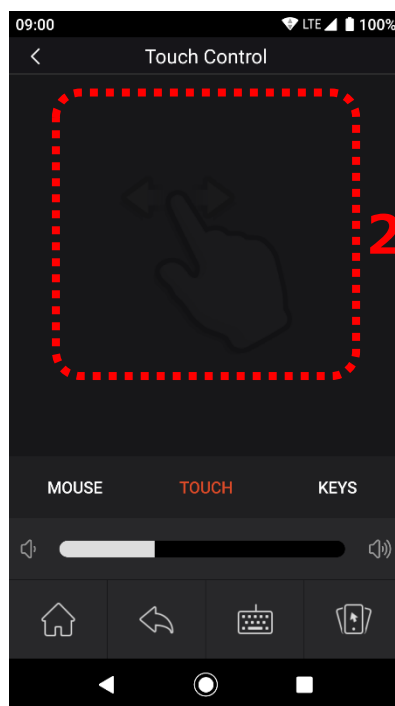

Touch mode

1. **Close:** close the Remote Control function.
2. **Control area:** touching this area performs remote operation to the display. This function can have different behavior, see item 3 and 4 below.
3. **MOUSE:** after selecting this mode, the Control area (number 2) will function like a touch pad. Touch input will move the cursor from its current position → you have to slide to get to the desired location.
4. **TOUCH:** after selecting this mode, the Control area (number 2) will function like an interactive display. The cursor will trigger an action wherever you touch the control area → touching the center moves the cursor to the center of the display, and touching the right edge moves the cursor to the right edge of the display.
5. **KEYS:** Select Keys mode. (see p.46)
6. **Volume:** adjusts the volume of the display.
7. **Home:** the display shows the home page. This is the application source by default.
8. **Back:** go back one step.
9. **Keyboard:** Start keyboard input. The characters you enter on your mobile device will be transferred and shown on the display.
10. **Air Mouse:** Select Air Mouse mode. (see p.47)

7.6 Remote Control



Keys mode

When selecting the keys mode, the Remote Control will function as a normal remote control.

1. **Close:** close the Remote Control function.
2. **Customize:** these buttons can be set as shortcuts to any app on the display. Clicking these buttons will launch the set app.
3. **▲▼▶◀:** these buttons have the same function as the cursor buttons on the remote control.
4. **OK:** the button has the same function as the ENTER button on the remote control
5. **PG+, PG-:** These functions are not used in the PN-LC652, PN-LC752 & PN-LC862

7.6 Remote Control

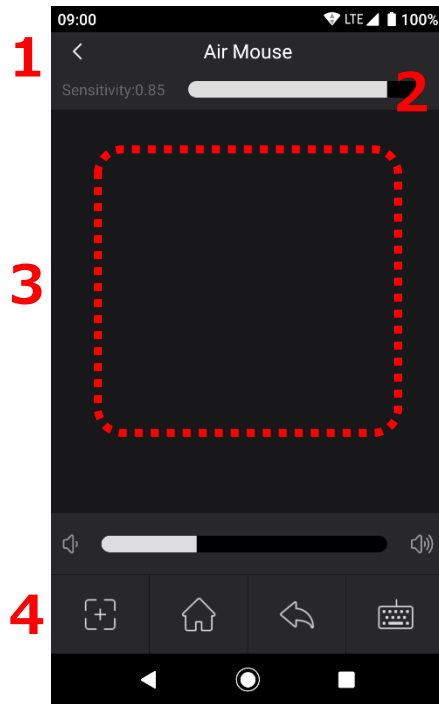

Air Mouse Mode

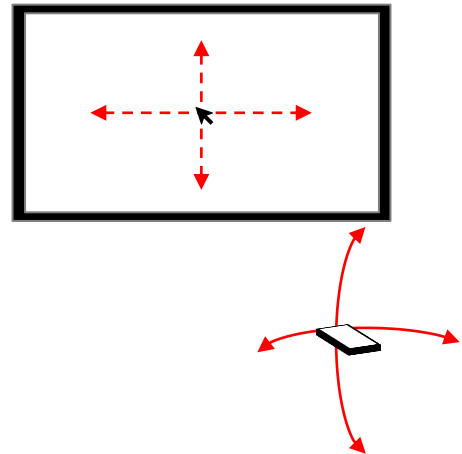

How to move your mobile device

The Air Mouse function allows you to move the cursor on the display up, down, left, or right by physically pointing your mobile device up, down, left, or right. Once the cursor is moved to the point you want to select, tap the touch area (number 2) to perform a touch operation on the cursor position on the display.

1. **Back:** exit Air Mouse function and go back to the start screen of the Remote Control.
2. **Sensitivity:** adjusts the amount of cursor movement relative to the movement of the mobile device.
3. **Touch area:** tap this area to perform a “click” with the cursor on the current position it is in on the display.
4. **Cursor reset:** returns the cursor on the display to the center of the screen.

8. Troubleshooting

8.1 Troubleshooting

Problem	Possible solution(s)
The QR-code is not working.	1. Check if the display has an active internet connection.
I cannot connect with my EShare Client application.	1. Check if you are in the same network → page 7 2. Make sure you downloaded the EShare Client application by using the onboard QR-code or used the shown IP-address.
I cannot use the Webcast function.	1. Check if the Webcast function is enabled → page 10. 2. Check if you are using the right browser → page 27. 3. Check if the correct ports are open → page 4.
I cannot see the Webcast ID, even though I check the settings & ports.	1. If there is no Webcast ID displayed, there is a temporary connection failure with the EShare server for Webcast, or a problem with the internet connection. This is not issue which can be solved on the display side. Please wait until it works again.
I have unwanted screensharing on the display.	1. Check if you set the right settings → page 17.
I cannot find the display when I am using my native screensharing solution (AirPlay, Google Cast).	1. Check if you are in the same network → page 7. 2. Check if the correct settings is turned on → page 17. 3. Check if the correct ports are open → page 4.
I cannot share with multiple screens at the same time.	1. Check if the multiscreen setting is correct → page 19. 2. Multiple streams of Google Cast will not work.
I do not have touchback functionality.	1. Check if you connecting from Windows or macOS using the EShare client app 2. Check if the touch enabled on the EShare server side → p.21
I cannot control / make annotation on the display while mirroring with the EShare Client application.	1. Check if you set the right settings → page 17. 2. Check if there is a pop-up message in the bottom right corner, which say the presenter to grant permission.
Some browsers/websites/apps show me the option to cast to the display directly. How does this work?	1. Please refer to the manual of the specific browser/website or application.
The stream is not smooth in Multiview with more than 4 devices connected.	1. If more than 4 still images or 1 movie are not displayed properly, please check the performance of the network, as this needs good bandwidth.

SHARP

SHARP CORPORATION