

Projector

PX750U2/PX700W2/PX800X2

User's Manual

Model No.

NP-PX750U, NP-PX750UG, NP-PX700W, NP-PX700WG, NP-PX800X, NP-PX800XG

- Each model is referred to as PX750U2, PX700W2, and PX800X2 respectively unless otherwise specified.

- DLP and BrilliantColor are trademarks of Texas Instruments.
- Macintosh, Mac OS X and PowerBook are trademarks of Apple Inc. registered in the U.S. and other countries.
- Microsoft, Windows, Windows Vista, Internet Explorer, .NET Framework and PowerPoint are either a registered trademark or trademark of Microsoft Corporation in the United States and/or other countries.
- MicroSaver is a registered trademark of Kensington Computer Products Group, a division of ACCO Brands.
- Adobe, Adobe PDF, Adobe Reader, and Acrobat are either registered trademarks or trademarks of Adobe Systems Incorporated in the United States and/or other countries.
- Virtual Remote Tool uses WinI2C/DDC library, © Nicomsoft Ltd.
- HDMI, the HDMI Logo and High-Definition Multimedia Interface are trademarks or registered trademarks of HDMI Licensing LLC.



- DisplayPort and DisplayPort Compliance Logo are trademarks owned by the Video Electronics Standards Association.



- Trademark PJLink is a trademark applied for trademark rights in Japan, the United States of America and other countries and areas.
- Wi-Fi®, Wi-Fi Alliance®, and Wi-Fi Protected Access (WPA, WPA2)® are registered trademarks of the Wi-Fi Alliance.
- Blu-ray is a trademark of Blu-ray Disc Association
- CRESTRON and ROOMVIEW are registered trademarks of Crestron Electronics, Inc. in the United States and other countries.
- Ethernet is either a registered trademark or trademark of Fuji Xerox Co., Ltd.
- Other product and company names mentioned in this user's manual may be the trademarks or registered trademarks of their respective holders.

NOTES

- (1) The contents of this user's manual may not be reprinted in part or whole without permission.
- (2) The contents of this user's manual are subject to change without notice.
- (3) Great care has been taken in the preparation of this user's manual; however, should you notice any questionable points, errors or omissions, please contact us.
- (4) Notwithstanding article (3), NEC will not be responsible for any claims on loss of profit or other matters deemed to result from using the Projector.

Important Information

Safety Cautions

Precautions

Please read this manual carefully before using your NEC projector and keep the manual handy for future reference.

CAUTION



To turn off main power, be sure to remove the plug from power outlet. The power outlet socket should be installed as near to the equipment as possible, and should be easily accessible.

CAUTION



TO PREVENT SHOCK, DO NOT OPEN THE CABINET. THERE ARE HIGH-VOLTAGE COMPONENTS INSIDE. REFER SERVICING TO QUALIFIED SERVICE PERSONNEL.



This symbol warns the user that uninsulated voltage within the unit may be sufficient to cause electrical shock. Therefore, it is dangerous to make any kind of contact with any part inside of the unit.



This symbol alerts the user that important information concerning the operation and maintenance of this unit has been provided. The information should be read carefully to avoid problems.

WARNING: TO PREVENT FIRE OR SHOCK, DO NOT EXPOSE THIS UNIT TO RAIN OR MOISTURE. DO NOT USE THIS UNIT'S PLUG WITH AN EXTENSION CORD OR IN AN OUTLET UNLESS ALL THE PRONGS CAN BE FULLY INSERTED.

DOC Compliance Notice (for Canada only)

This Class B digital apparatus meets all requirements of the Canadian Interference-Causing Equipment Regulations.

Machine Noise Information Regulation - 3. GPSGV,

The highest sound pressure level is less than 70 dB (A) in accordance with EN ISO 7779.

Disposing of your used product



EU-wide legislation as implemented in each Member State requires that used electrical and electronic products carrying the mark (left) must be disposed of separately from normal household waste. This includes projectors and their electrical accessories or lamps. When you dispose of such products, please follow the guidance of your local authority and/or ask the shop where you purchased the product.

After collecting the used products, they are reused and recycled in a proper way. This effort will help us reduce the wastes as well as the negative impact such as mercury contained in a lamp to the human health and the environment at the minimum level.

The mark on the electrical and electronic products only applies to the current European Union Member States.

WARNING



- When the projector is damaged, cooling fluids may come out of internal part. Should this happen, immediately turn off the AC supply to the projector and contact your dealer. DO NOT touch and drink the cooling fluid. When the cooling fluids are swallowed or contacted with your eyes, please consult medical attention immediately. If you touch the cooling fluid with your hand, rinse your hands well under running water.

WARNING TO CALIFORNIA RESIDENTS:

Handling the cables supplied with this product will expose you to lead, a chemical known to the State of California to cause birth defects or other reproductive harm. WASH HANDS AFTER HANDLING.

RF Interference (for USA only)

WARNING

The Federal Communications Commission does not allow any modifications or changes to the unit EXCEPT those specified by NEC Display Solutions of America, Inc. in this manual. Failure to comply with this government regulation could void your right to operate this equipment. This equipment has been tested and found to comply with the limits for a Class B digital device, pursuant to Part 15 of the FCC Rules. These limits are designed to provide reasonable protection against harmful interference in a residential installation. This equipment generates, uses, and can radiate radio frequency energy and, if not installed and used in accordance with the instructions, may cause harmful interference to radio communications. However, there is no guarantee that interference will not occur in a particular installation.

If this equipment does cause harmful interference to radio or television reception, which can be determined by turning the equipment off and on, the user is encouraged to try to correct the interference by one or more of the following measures:

- Reorient or relocate the receiving antenna.
- Increase the separation between the equipment and receiver.
- Connect the equipment into an outlet on a circuit different from that to which the receiver is connected.
- Consult the dealer or an experienced radio / TV technician for help.

For UK only: In UK, a BS approved power cord with moulded plug has a Black (five Amps) fuse installed for use with this equipment. If a power cord is not supplied with this equipment please contact your supplier.

Important Safeguards

These safety instructions are to ensure the long life of your projector and to prevent fire and shock. Please read them carefully and heed all warnings.

Installation

- Do not place the projector in the following conditions:
 - on an unstable cart, stand, or table.
 - near water, baths, or damp rooms.
 - in direct sunlight, near heaters, or heat radiating appliances.
 - in a dusty, smoky or steamy environment.
 - on a sheet of paper or cloth, rugs or carpets.
- If you wish to have the projector installed on the ceiling:
 - Do not attempt to install the projector yourself.
 - The projector must be installed by qualified technicians in order to ensure proper operation and reduce the risk of bodily injury.
 - In addition, the ceiling must be strong enough to support the projector and the installation must be in accordance with any local building codes.
 - Please consult your dealer for more information.

WARNING

- Do not cover the lens with the lens cap or equivalent while the projector is on. Doing so can lead to melting of the cap due to the heat emitted from the light output.
- Do not place any objects, which are easily affected by heat, in front of the projector lens. Doing so could lead to the object melting from the heat that is emitted from the light output.



Orientation and Fan Mode

- Do not tilt the projector to the left or right. Doing so may result in malfunction. There is no limit on the tilt angle upward or downward. Select the appropriate option for [FAN MODE] according to the installation angle.
- When changing the projector orientation or installation angle, also change the [SETTING] option of [FAN MODE] accordingly. Failure to do so may cause product malfunction. (→ page 122, 123, 128)



⚠ Fire and Shock Precautions ⚠

- Ensure that there is sufficient ventilation and that vents are unobstructed to prevent the build-up of heat inside your projector. Allow minimum spaces between your projector and a wall. (→ page v and vi)
- Do not try to touch the ventilation outlet on the rear side of the cabinet as it can become heated while the projector is turned on and immediately after the projector is turned off. Parts of the projector may become temporarily heated if the projector is turned off with the POWER button or if the AC power supply is disconnected during normal projector operation.

Use caution when picking up the projector.



HOT

- Prevent foreign objects such as paper clips and bits of paper from falling into your projector. Do not attempt to retrieve any objects that might fall into your projector. Do not insert any metal objects such as a wire or screwdriver into your projector. If something should fall into your projector, disconnect it immediately and have the object removed by a qualified service personnel.
- Do not place any objects on top of the projector.
- Do not touch the power plug during a thunderstorm. Doing so can cause electrical shock or fire.
- The projector is designed to operate on a power supply of 100-240V AC 50/60 Hz (PX750U2/PX700W2/PX800X2)/200-240V AC 50/60Hz (PX750UG2/PX700WG2/PX800XG2). Ensure that your power supply fits this requirement before attempting to use your projector.
- Do not look into the lens while the projector is on. Serious damage to your eyes could result.

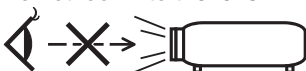

- Keep any items (magnifying glass etc.) out of the light path of the projector. The light path being projected from the lens is extensive, therefore any kind of abnormal objects that can redirect light coming out of the lens, can cause an unpredictable outcome such as a fire or injury to the eyes.
- Do not place any objects, which are easily affected by heat, in front of a projector exhaust vent. Doing so could lead to the object melting or getting your hands burned from the heat that is emitted from the exhaust.
- Handle the power cord carefully. A damaged or frayed power cord can cause electric shock or fire.

- Do not use any power cord other than the one supplied with the projector.
- Do not bend or tug the power cord excessively.
- Do not place the power cord under the projector, or any heavy object.
- Do not cover the power cord with other soft materials such as rugs.
- Do not heat the power cord.
- Do not handle the power plug with wet hands.
- Turn off the projector, unplug the power cord and have the projector serviced by a qualified service personnel under the following conditions:
 - When the power cord or plug is damaged or frayed.
 - If liquid has been spilled into the projector, or if it has been exposed to rain or water.
 - If the projector does not operate normally when you follow the instructions described in this user's manual.
 - If the projector has been dropped or the cabinet has been damaged.
 - If the projector exhibits a distinct change in performance, indicating a need for service.
- Disconnect the power cord and any other cables before carrying the projector.
- Turn off the projector and unplug the power cord before cleaning the cabinet or replacing the lamp.
- Turn off the projector and unplug the power cord if the projector is not to be used for an extended period of time.
- When using a LAN cable:
For safety, do not connect to the connector for peripheral device wiring that might have excessive voltage.

CAUTION

- A minimum of two persons are required to carry the projector. Otherwise the projector may tumble or drop, causing personal injury.
- Keep hands away from the lens mounting portion while the lens shift is in operation. Failure to do so could result in hands being pinched by the moving lens.
- Do not use the tilt-foot for purposes other than originally intended. Misuses such as gripping the tilt-foot or hanging on the wall can cause damage to the projector.
- Do not send the projector in the soft case by parcel delivery service or cargo shipment. The projector inside the soft case could be damaged.
- Set [LAMP SELECT] and [LAMP INTERVAL MODE] if you continue to use the projector for consecutive days. (From the menu, select [LAMP MODE] → [LAMP SELECT] and [LAMP INTERVAL MODE].)
- Before using Direct Power Off, be sure to allow at least 20 minutes immediately after turning on the projector and starting to display an image.
- Do not unplug the power cord from the wall outlet or projector when the projector is powered on. Doing so can cause damage to the AC IN connector of the projector and (or) the prong plug of the power cord. To turn off the AC power supply when the projector is powered on, use the projector's main power switch or a power strip equipped with a switch and a breaker.
- Do not turn off the AC power for 60 seconds after the lamp is turned on and while the POWER indicator is blinking blue. Doing so could cause premature lamp failure.
- Use of a wall outlet with a 20 A or more circuit breaker is recommended.

Performing Lens Calibration After Installation of the Optional Lens

Be sure to perform [CALIBRATION] by pressing and holding the ORIENTATION/CALIBRATION button for at least 2 seconds or by holding the CTL button and pressing the INFO/L-CALIB button on the remote control after installation or replacement of the lens. (→ page 125) Calibration corrects the adjustable zoom and focus range.

The following lenses need calibration:

- NP16FL, NP17ZL, NP18ZL, NP19ZL, NP20ZL, NP21ZL, NP31ZL

Caution on Carrying the Projector/Handling the Optional Lens

When shipping the projector with the lens, remove the lens before shipping the projector. Always attach the dust cap to the lens whenever it is not mounted on the projector. The lens and the lens shift mechanism may encounter damage caused by improper handling during transportation.

Remote Control Precautions

- Handle the remote control carefully.
- If the remote control gets wet, wipe it dry immediately.
- Avoid excessive heat and humidity.
- Do not short, heat, or take apart batteries.
- Do not throw batteries into fire.
- If you will not be using the remote control for a long time, remove the batteries.
- Ensure that you have the batteries' polarity (+/-) aligned correctly.
- Do not use new and old batteries together, or use different types of batteries together.
- Dispose of used batteries according to your local regulations.

Note for US Residents

The lamps in this product contain mercury. Please dispose according to Local, State or Federal Laws.

Lamp and Color Wheel Replacement

- Use the specified lamp for safety and performance.
- To replace the lamp and the color wheel, follow all instructions provided on page [182](#) and [217](#) respectively.
- Be sure to replace the lamp when the message **[THE LAMP HAS REACHED THE END OF ITS USABLE LIFE. PLEASE REPLACE THE LAMP 1 (OR 2). USE THE SPECIFIED LAMP FOR SAFETY AND PERFORMANCE.]** appears. If you continue to use the lamp after the lamp has reached the end of its usable life, the lamp bulb may shatter, and pieces of glass may be scattered in the lamp case. Do not touch them as the pieces of glass may cause injury.
If this happens, contact your dealer for lamp replacement.

A Lamp Characteristic

The projector has a discharge lamp for special purposes as a light source.

A lamp has a characteristic that its brightness gradually decreases with age. Also repeatedly turning the lamp on and off will increase the possibility of its lower brightness.

The actual lamp life may vary depending upon the individual lamp, the environmental conditions and usage.

CAUTION:

- DO NOT TOUCH THE LAMP or THE COLOR WHEEL immediately after it has been used. It will be extremely hot. Turn the projector off and then disconnect the power cord. Allow at least one hour for the lamp to cool before handling.
- When removing the lamp from a ceiling-mounted projector, make sure that no one is under the projector. Glass fragments could fall if the lamp has been burned out.

Clearance for Installing the Projector

Allow ample clearance between the projector and its surroundings as shown below.

Avoid installing the projector in a place where air movement from the HVAC is directed at the projector.

Heated air from the HVAC can be taken in by the projector's intake vent. If this happens, the temperature inside the projector will rise too high causing the over-temperature protector to automatically turn off the projectors power.

Example 1 – If there are walls on both sides of the projector.

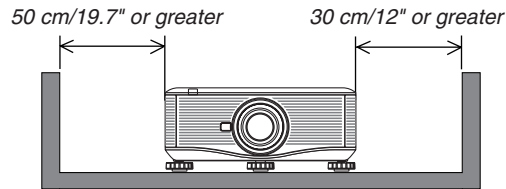

NOTE:

The drawing shows the proper clearance required for the front, back and top of the projector.

Example 2 – If there is a wall behind the projector.

(1) For floor installation:

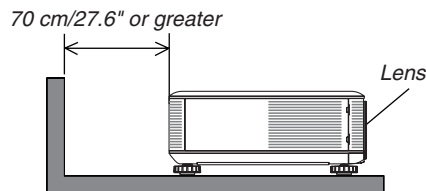

NOTE:

The drawing shows the proper clearance required for the back, sides and top of the projector.

(2) For ceiling mounting:

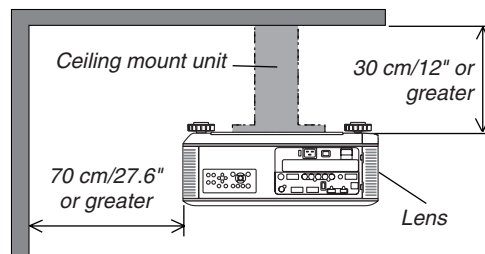

NOTE:

1. The drawing shows the proper clearance required for the front, sides, back and bottom of the projector.
2. If suspending the projector 30 cm/12 inches away from the ceiling, allow ample clearance for all four sides and the under the projector.

(3) Upward or downward projection:

When using the projector in an upward projection angle, allow 1 m/ 40 inches or greater between the exhaust vent and the wall.

When using the projector in a downward projection angle, allow 70 cm/ 27.6 inches or greater between the exhaust vent and the wall.

About High Altitude mode

- Set [FAN MODE] to [HIGH ALTITUDE] when using the projector at altitudes approximately 5500 feet/1600 meters or higher.
Using the projector at altitudes approximately 5500 feet/1600 meters or higher without setting to [HIGH ALTITUDE] can cause the projector to overheat and the projector could shut down. If this happens, wait a couple minutes and turn on the projector.
- Using the projector at altitudes less than approximately 5500 feet/1600 meters and setting to [HIGH ALTITUDE] can cause the lamp to overcool, causing the image to flicker. Switch [FAN MODE] to [AUTO].
- Using the projector at altitudes approximately 5500 feet/1600 meters or higher can shorten the life of internal parts such as the lamp.

About Copyright of original projected pictures:

Please note that using this projector for the purpose of commercial gain or the attraction of public attention in a venue such as a coffee shop or hotel and employing compression or expansion of the screen image with the following functions may raise concern about the infringement of copyrights which are protected by copyright law. [ASPECT RATIO], [3D REFORM], [D-ZOOM] feature and other similar features.

Turkish RoHS information relevant for Turkish market

EEE Yönetmeliğine Uygundur.

This device is not intended for use in the direct field of view at visual display workplaces. To avoid incommoding reflections at visual display workplaces this device must not be placed in the direct field of view.

Table of Contents

Important Information	i
1. Introduction	1
1 What's in the Box?	1
2 Introduction to the Projector	2
Congratulations on Your Purchase of the Projector	2
Features you'll enjoy:	2
About this user's manual.....	3
3 Part Names of the Projector	4
Front/Top.....	4
Rear	5
Control Panel/Indicator Section	6
Terminal Panel Features	7
4 Part Names of the Remote Control	8
Battery Installation	9
Remote Control Precautions.....	9
Operating Range for Wireless Remote Control.....	9
Using the Remote Control in Wired Operation.....	10
5 Operating Environment for Software Included on CD-ROM	11
Operating Environment	12
2. Projecting an Image (Basic Operation)	13
1 Flow of Projecting an Image.....	13
2 Connecting Your Computer/Connecting the supplied Power Cord	14
Using the Supplied Power Cord Stopper	15
3 Turning on the Projector	17
Performing Lens Calibration	18
Note on Startup screen (Menu Language Select screen).....	19
If the projected image is inverted or upside down.....	20
4 Selecting a Source	21
Selecting the computer or video source.....	21
5 Adjusting the Picture Size and Position	22
Adjusting the vertical position of a projected image (Lens shift).....	23
Focus	25
Zoom.....	28
Adjusting the Tilt Feet	29
6 Correcting Keystone Distortion.....	30
7 Optimizing Computer Signal Automatically	32
Adjusting the Image Using Auto Adjust.....	32
8 Turning off the Projector	33
9 After Use.....	34
3. Convenient Features	35
1 Blocking the lamp light (LENS SHUTTER).....	35
2 Turning off the Image.....	35
3 Turning Off the On-Screen Menu (On-Screen Mute).....	35
4 Freezing a Picture	35

5	Enlarging a Picture	36
6	Changing Eco Mode/Checking Energy-Saving Effect Using Eco Mode [ECO MODE] 37 Checking Energy-Saving Effect [CARBON METER]	38
7	Correcting Horizontal and Vertical Keystone Distortion [CORNERSTONE]	39
	Cornerstone	39
8	Displaying Two Pictures at the Same Time.....	42
	Selecting the PIP or PICTURE BY PICTURE Mode [MODE].....	42
	[POSITION].....	43
9	Preventing the Unauthorized Use of the Projector [SECURITY]	44
10	Storing Changes for Lens Shift, Zoom, and Focus [LENS MEMORY]	47
	Usage Example.....	47
	To store your adjusted values in [REF. LENS MEMORY]:.....	47
	To call up your adjusted values from [REF. LENS MEMORY]:.....	49
11	Displaying a Picture Using [EDGE BLENDING]	51
	Before explaining use of the Edge Blending function.....	51
	Black Level Adjustment.....	54
	9-segmented portions for Black Level adjustment	55
12	Controlling the Projector by Using an HTTP Browser	56
13	Projecting Your Computer's Screen Image from the Projector via a Network [NETWORK PROJECTOR].....	63
14	Using the Projector to Operate Your Computer via a Network [REMOTE DESKTOP]	67
4.	Using the Viewer	73
1	What you can do with the Viewer.....	73
2	Preparing presentation materials	76
3	Projecting images stored in a USB memory device	77
	Starting the Viewer.....	77
	Exiting the Viewer	80
	Names and functions of Viewer screen.....	81
	Viewer option settings.....	86
4	Projecting data from shared folder	89
	Connecting the projector to the shared folder	89
	Disconnecting the shared folder from the projector	92
5	Projecting data from media server.....	93
	Setting up "Media Sharing" in Windows Media Player 11	93
	Setting up "Media Sharing" in Windows Media Player 12	95
	Connecting the projector to the media server	96
	Disconnecting the projector from the media server	97
6	Restrictions on displaying files	98
	Some restrictions on PowerPoint files.....	98
	Some restrictions on PDF files	98
5.	Using On-Screen Menu.....	99
1	Using the Menus.....	99
2	Menu Elements.....	100
3	List of Menu Items	101
4	Menu Descriptions & Functions [SOURCE]	104
	COMPUTER 1, 2, and 3	104

HDMI.....	104
DisplayPort.....	104
VIDEO.....	104
S-VIDEO.....	104
VIEWER.....	104
NETWORK.....	104
SLOT (for optional board).....	104
ENTRY LIST.....	104
TEST PATTERN.....	104
5 Menu Descriptions & Functions [ADJUST].....	108
[PICTURE].....	108
[IMAGE OPTIONS].....	111
[VIDEO].....	115
Using the Lens Memory Function [LENS MEMORY].....	116
6 Menu Descriptions & Functions [SETUP].....	117
[BASIC].....	117
[MENU].....	121
[INSTALLATION(1)].....	122
[INSTALLATION(2)].....	126
[OPTIONS(1)].....	128
[OPTIONS(2)].....	130
[EDGE BLENDING].....	132
7 Menu Descriptions & Functions [INFO.].....	133
[USAGE TIME].....	133
[SOURCE(1)].....	134
[SOURCE(2)].....	134
[WIRED LAN].....	134
[WIRELESS LAN(1)].....	135
[WIRELESS LAN(2)].....	135
[VERSION(1)].....	135
[VERSION(2)].....	136
[OTHERS].....	136
8 Menu Descriptions & Functions [RESET].....	137
Returning to Factory Default [RESET].....	137
9 Application Menu.....	139
IMAGE EXPRESS UTILITY.....	139
NETWORK PROJECTOR.....	139
REMOTE DESKTOP CONNECTION.....	140
NETWORK SETTINGS.....	141
TOOLS.....	157
6. Connecting to Other Equipment	162
1 Mounting a lens (sold separately).....	162
Mounting the lens.....	162
Removing the lens.....	163
2 Making Connections.....	164
Analog RGB signal connection.....	164
Digital RGB signal connection.....	165
Connecting an External Monitor.....	167
Connecting Your DVD Player or Other AV Equipment.....	168
Connecting Component Input.....	169

Connecting HDMI Input.....	170
Connecting to a Wired LAN	171
Connecting to a Wireless LAN (sold separately).....	172
Mounting a wireless LAN unit	172
To remove the wireless LAN unit.....	174
Stacking projectors	176
7. Maintenance	179
① Cleaning the Filters.....	179
② Cleaning the Lens.....	181
③ Cleaning the Cabinet.....	181
④ Replacing the Lamp and the Filters.....	182
⑤ Replacing the Filters.....	185
8. User Supportware	187
① Installing Software Program	187
Installation for Windows software.....	187
Installation for Macintosh software.....	190
② Projecting Images or Videos from the Projector over a LAN (Image Express Utility 2.0).....	191
What you can do with Image Express Utility 2.0.....	191
Connecting the projector to a LAN.....	192
Basic Operation of Image Express Utility 2.0.....	193
③ Controlling the Projector over a LAN (PC Control Utility Pro 4).....	202
④ Projecting Your Mac's Screen Image from the Projector over a LAN (Image Express Utility 2 for Mac)	203
What you can do with Image Express Utility 2.....	203
Operating environment	203
Connecting the projector to a LAN.....	203
Using Image Express Utility 2.....	204
⑤ Operating the Projector Via the LAN (Virtual Remote Tool).....	207
⑥ Converting PowerPoint files to Slides (Viewer PPT Converter 3.0).....	210
9. Appendix.....	212
① Throw distance and screen size	212
Tables of screen sizes and dimensions	212
Lens types and throw distance	213
Lens shifting range.....	216
② Replacing the Color Wheel (included)	217
Storing Unused Color Wheel:.....	219
③ Mounting the Optional Board (sold separately)	220
④ Compatible Input Signal List.....	222
⑤ Specifications	224
Optical.....	224
Electrical	224
Mechanical.....	225
Option lens.....	226
⑥ Cabinet Dimensions	227

Table of Contents

7	Pin Assignments of D-Sub COMPUTER Input Connector	228
8	Troubleshooting	229
	Indicator Messages.....	229
	Common Problems & Solutions	231
	If there is no picture, or the picture is not displayed correctly.....	233
9	PC Control Codes and Cable Connection	234
10	Troubleshooting Check List.....	235
11	REGISTER YOUR PROJECTOR! (for residents in the United States, Canada, and Mexico)	237

1. Introduction

① What's in the Box?

Make sure your box contains everything listed. If any pieces are missing, contact your dealer. Please save the original box and packing materials if you ever need to ship your projector.

Projector

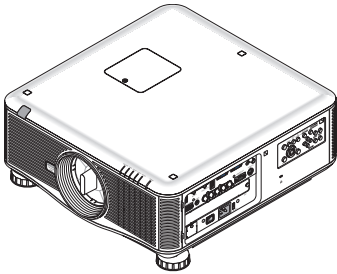

Dust cap for lens (79TM1061)
* The projector is shipped without a lens. For the types of lens and throw distances, see page 213, 214, 215.

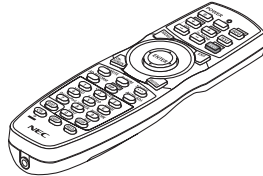

Remote control (7N901041)

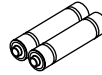

AA alkaline batteries (x2)

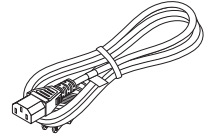

Power cord
(US: 79TM1001 for AC 120 V and 79TM1011 for AC 200 V)
(EU: 79TM1021)

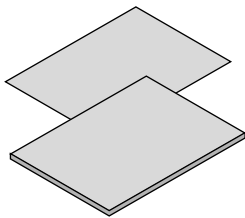

- Important Information (For North America: 7N8N4841) (For Other countries than North America: 7N8N4841 and 7N8N4851)
- Quick Setup Guide (For North America: 7N8N4861) (For Other countries than North America: 7N8N4861 and 7N8N4871)

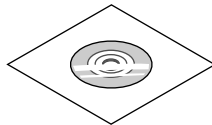

NEC Projector CD-ROM
User's manual (PDF) and the utility software (7N952052)

For North America only:
Limited warranty
For customers in Europe:
You will find our current valid Guarantee Policy on our Web Site:
www.nec-display-solutions.com

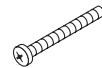

Lens theft prevention screw (79TM1071)
This screw makes it difficult to remove the lens mounted on the projector. (→ page 163)

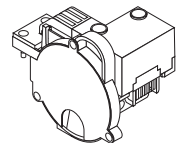

6-segment color wheel (79TM1081)
Stacking holders (x 3) (79TM1101)
Power cord stopper (79TM1111)
Anti-theft cap for LAN unit (for optional wireless LAN unit) (79TM1091)

Attaching/Removing the Dust Cap

To remove the dust cap from the projector, pull the upper end of the dust cap while clutching it.

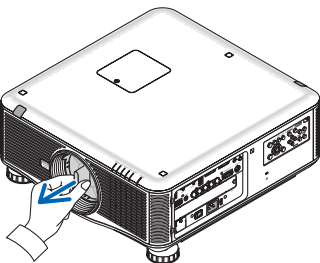

To attach the dust cap to the projector, locate the catch on the lower end of the dust cap and place it into the opening of the projector with the point of a triangle mark (▽) facing downward (① in the figure below), and then push the upper end of the dust cap against the projector to place the catches into the slot while clutching the handle (② in the figure below).

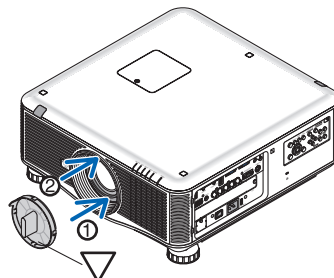

② Introduction to the Projector

This section introduces you to your new projector and describes the features and controls.

Congratulations on Your Purchase of the Projector

This projector is one of the very best projectors available today. The projector enables you to project precise images up to 500 inches (200 or 300 inches depending on the optional lens) across (measured diagonally) from your PC or Macintosh computer (desktop or notebook), VCR, DVD player, or document camera.

You can use the projector on a tabletop or cart, you can use the projector to project images from behind the screen, and the projector can be permanently mounted on a ceiling*¹. The remote control can be used wirelessly.

*¹ Do not attempt to mount the projector on a ceiling yourself.

The projector must be installed by qualified technicians in order to ensure proper operation and reduce the risk of bodily injury.

In addition, the ceiling must be strong enough to support the projector and the installation must be in accordance with any local building codes. Please consult your dealer for more information.

Features you'll enjoy:

- **DLP® projector with high resolution and high brightness**

High resolution display – PX750U2: WUXGA (1920 × 1200) native resolution (16:10), PX700W2: WXGA (1280 × 800) native resolution (16:10), PX800X2: XGA (1024 × 768) native resolution (4:3)

- **Wide range of optional lenses selectable according to the place of installation**

This projector supports 7 types* of optional lenses, providing a selection of lenses adapted for a variety of installation requirements.

In addition, the lenses can be mounted and removed in one touch.

Note that no lens is mounted upon shipment from the factory. Please purchase optional lenses separately.

* 6 types for PX700W2 and PX800X2

- **Dual Lamp system**

Two lamp system offers increased lamp life and energy savings along with redundancy.

- **Double stackable for built in redundancy and high light output requirements**

Double stacking projectors increase the brightness and visibility.

- **EDGE BLENDING function**

The EDGE BLENDING function allows a multi-screen image with high resolution to be displayed on a large screen.

- **Powered Lens Shift, Zoom, and Focus offer installation flexibility**

Powered Horizontal and Vertical lens shift provides the ability to project from off center screen installations. Powered zoom and focus provide quick and easy adjustment.

- **360° installation angle (tilt-free)**

The projector can be installed at any angle (360°).

Note, however, that the “fan mode” setting must be changed according to the angle of installation.

Also, the projector cannot be installed tilted to the left or right.

- **Two types of color wheels (6-segment white) and (6-segment color) interchangeable**

The projector is shipped with the 6-segment white color wheel installed. You can replace it with the included 6-segment color wheel to create images with more brilliant colors to match the source.

- **Wide range of input/output connectors (HDMI, DisplayPort, BNC, etc.)**

The projector is equipped with a variety of input/output connectors: computer (analog), 5 BNC, HDMI, DisplayPort, Video, S-Video, etc. (The computer (analog) and BNC connectors also support component inputs.)

The projector's HDMI and DisplayPort input connectors support HDCP.

- **Slot for optional board**

The projector has a slot for the optional board (SB-01HC or other NEC's interface boards).

- **High picture quality processing circuit**

The Reon-VX video processor is used to project high quality images.

- **Energy-saving design with a standby power consumption of 0.4 Watts or less**

When the on-screen menu's standby mode is set to "Power Saving", the power consumption in the standby mode is 0.2 W (100-130 V AC)/ 0.4W (200-240V AC).

- **"Eco mode" for low power consumption and "Carbon Meter" display**

The projector is equipped with an "eco mode" for reducing power consumption during use. Furthermore, the power-saving effect when the eco mode is set is converted into the amount of reductions of CO₂ emissions and this is indicated on the confirmation message displayed when the power is turned off and at "Information" on the on-screen menu (CARBON METER).

- **Seamless switch function for smoother screen changes when switching the signal (for PX750U2 only)**

When the input connector is switched, the image displayed before switching is held so that that projector can write the new image without going to black.

- **Simultaneous display of 2 images (PIP/PICTURE BY PICTURE)**

Two images can be projected simultaneously with a single projector.

There are two types of layouts for the two images: "picture-in-picture" in which a sub-picture is displayed on the main picture, and "picture-by-picture" in which the main and sub pictures are displayed next to each other.

- **Security function for preventing unauthorized use**

This projector is equipped with the following security functions:

- Password security: When a password is set in the on-screen menu, a screen to input the password appears when the projector's power is turned on.
- Theft prevention lock: A security cable compatible with Kensington locks can be connected to the projector.

- **Wired/wireless LAN compatibility (wireless LAN unit sold separately)**

The projector is equipped with a LAN port (RJ-45) for connection to a wired LAN for transferring images from a computer to the projector, controlling the projector from a computer, etc.

Furthermore, the projector can be used in a wireless LAN by mounting the separately sold wireless LAN unit (NP02LM).

- **Convenient utility software (User Supportware) provided as standard**

Three utility software programs (Image Express Utility 2.0, PC Control Utility Pro 4, Image Express Utility 2 for Mac) are provided on the included NEC Projector CD-ROM. Two more utility software programs can be downloaded from our website: Virtual Remote Tool and Viewer PPT Converter 3.0.

- **LAN-compatible viewer function**

Still and moving images in shared folders on a computer connected by wired or wireless LAN can be projected with the projector's viewer.

- The viewer supports the Windows Media Player 11's "media sharing" function.

- **CRESTRON ROOMVIEW compatibility**

The projector supports CRESTRON ROOMVIEW, allowing multiple devices connected in the network to be managed and controlled from a computer or controller.

About this user's manual

The fastest way to get started is to take your time and do everything right the first time. Take a few minutes now to review the user's manual. This may save you time later on. At the beginning of each section of the manual you'll find an overview. If the section doesn't apply, you can skip it.

3 Part Names of the Projector

Front/Top

The lens is sold separately. The description below is for when the NP18ZL lens is mounted on the PX750U2.

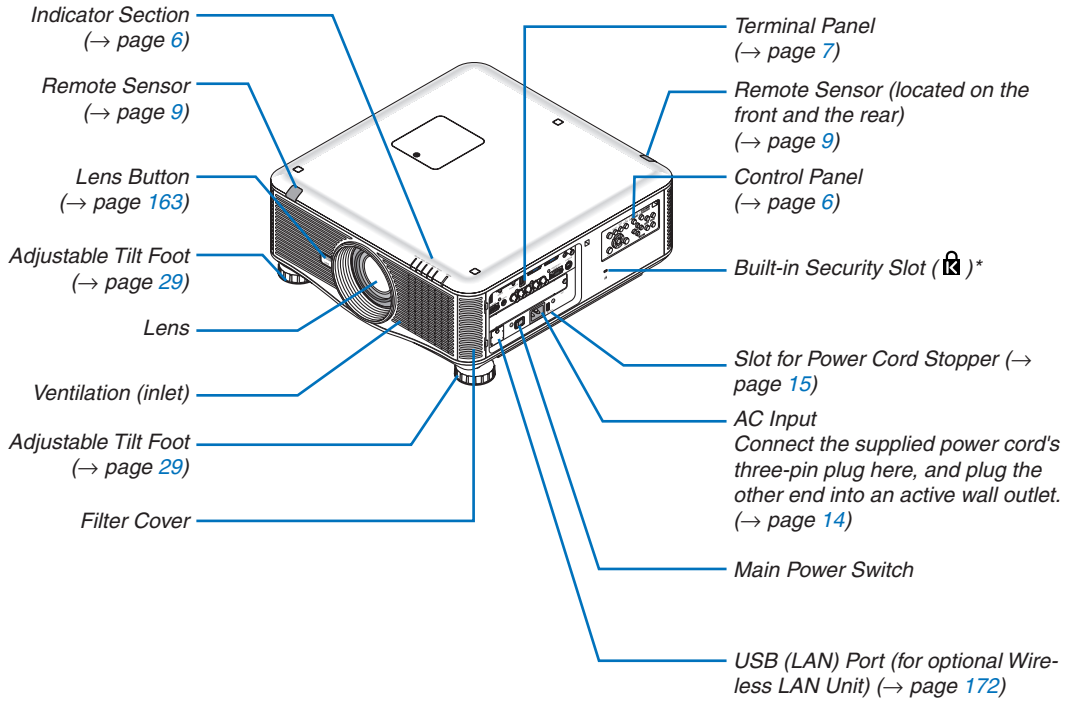

* This security slot supports the MicroSaver® Security System.



Lens Cap
(The lens cap is attached to the lens.)

Rear

CAUTION:

Parts of the projector may become temporarily heated if the projector is turned off with the POWER button or if the AC power supply is disconnected during normal projector operation. Use caution when picking up the projector.

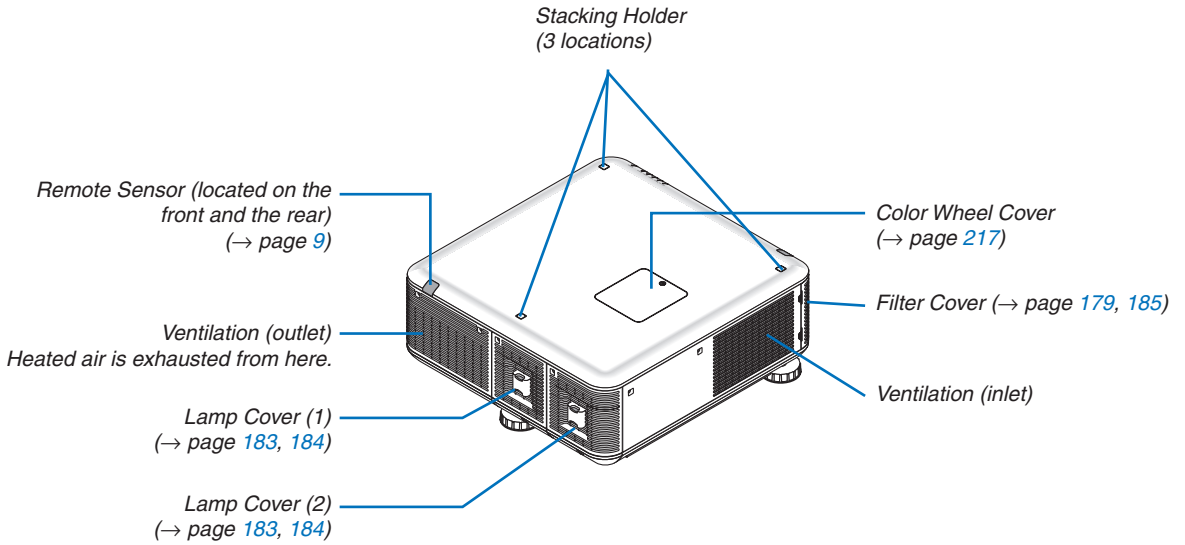

Control Panel/Indicator Section

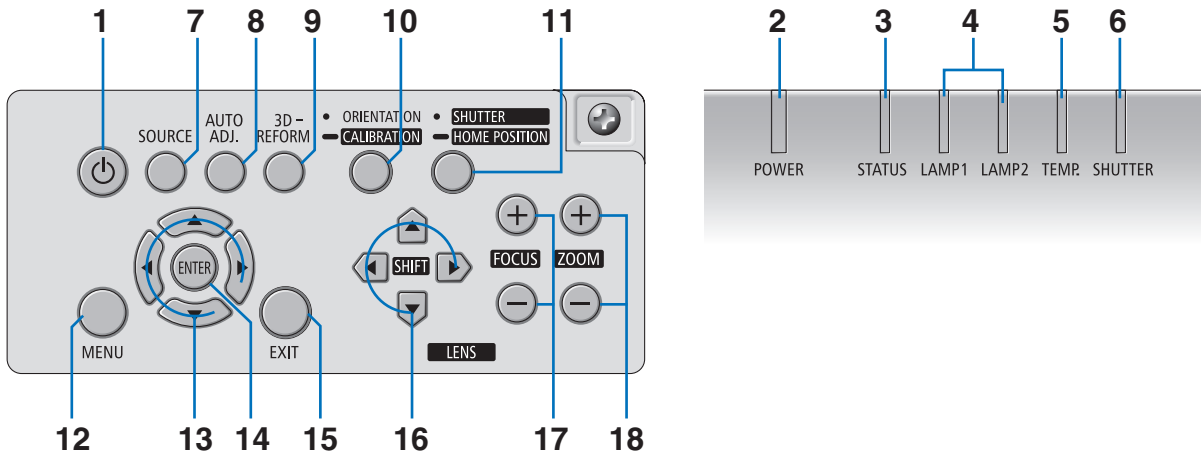

1. (POWER) Button (→ page 18, 33)
2. POWER Indicator (→ page 18, 33, 229)
3. STATUS Indicator (→ page 229)
4. LAMP 1 and LAMP 2 Indicators (→ page 182, 230)
5. TEMP. Indicator (→ page 230)
6. SHUTTER Indicator (→ page 230)
7. SOURCE Button (→ page 21)
8. AUTO ADJ. Button (→ page 32)
9. 3D REFORM Button (→ page 39)
10. ORIENTATION/CALIBRATION Button (→ page 18, 20)
11. SHUTTER/HOME POSITION Button (→ page 23, 35)

NOTE: The "home position" for lens shift position is not the center position of the adjustable lens shift range. The home position should be used for lens installation.

12. MENU Button (→ page 99)
13. Buttons (→ page 99)
14. ENTER Button (→ page 99)
15. EXIT Button (→ page 99)
16. LENS SHIFT Buttons (→ page 23)
17. FOCUS +/- Buttons (→ page 25)
18. ZOOM +/- Buttons (→ page 28)

Terminal Panel Features

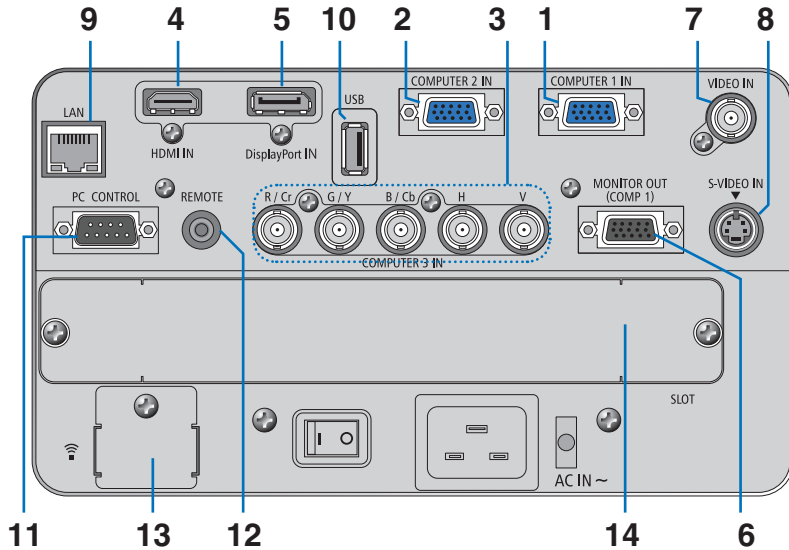

1. **COMPUTER 1 IN / Component Input Connector (Mini D-Sub 15 Pin)** (→ page [14](#), [164](#), [169](#))
2. **COMPUTER 2 IN / Component Input Connector (Mini D-Sub 15 Pin)** (→ page [164](#), [169](#))
3. **COMPUTER 3 IN/Component (R/Cr, G/Y, B/Cb, H, V) Connectors (BNC × 5)** (→ page [164](#), [169](#))
4. **HDMI IN Connector (Type A)** (→ page [165](#), [166](#), [170](#))
5. **DisplayPort IN Connector (DisplayPort 20P)** (→ page [165](#))
6. **MONITOR OUT (COMP 1) Connector (Mini D-Sub 15 Pin)** (→ page [167](#))
7. **VIDEO IN Connector (BNC)** (→ page [168](#))
8. **S-VIDEO IN Connector (Mini DIN 4 Pin)** (→ page [168](#))
9. **LAN Port (RJ-45)** (→ page [171](#))
10. **USB Port (Type A)** (→ page [77](#))
11. **PC CONTROL Port (D-Sub 9 Pin)** (→ page [234](#))

Use this port to connect a PC or control system. This enables you to control the projector using serial communication protocol. If you are writing your own program, typical PC control codes are on page [234](#).

12. REMOTE Jack (Stereo Mini)

Use this jack for wired remote control of the projector using a commercially available remote cable with $\varnothing 3.5$ stereo mini-plug (without resistance).

Connect the projector and the supplied remote control using a commercially available wired remote control cable. (→ page [10](#))

13. USB (LAN) Port (for optional Wireless LAN Unit)

 (→ page [172](#))

14. Optional Slot (SLOT)

 (→ page [220](#))

4 Part Names of the Remote Control

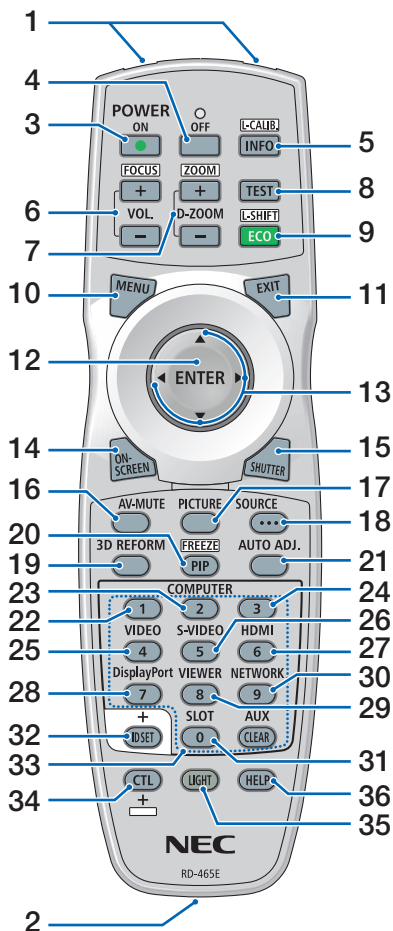

1. **Infrared Transmitter**
(→ page 9)
2. **Remote Jack**
Connect a commercially available remote cable here for wired operation. (→ page 10)
3. **POWER ON Button**
(→ page 18)
4. **POWER OFF Button**
(→ page 33)
5. **INFO/L-CALIB. Button**
(→ page 18) (The function of the INFO button will not work on this series of projectors.)
6. **VOL./FOCUS +/- Buttons**
(→ page 25)
7. **D-ZOOM/ZOOM +/- Buttons**
(→ page 28)
8. **TEST Button**
(→ page 22)
9. **ECO/L-SHIFT Button**
(→ page 24)
10. **MENU Button**
(→ page 99)
11. **EXIT Button**
(→ page 99)
12. **ENTER Button**
(→ page 99)
13. **▲▼◀▶ Button**
(→ page 99)
14. **ON-SCREEN Button**
(→ page 35)
15. **SHUTTER Button**
(→ page 35)
16. **AV-MUTE Button**
(→ page 35)
17. **PICTURE Button**
(→ page 108, 110)
18. **SOURCE Button**
(→ page 21)
19. **3D REFORM Button**
(→ page 39)
20. **PIP/FREEZE Button**
(→ page 35, 42)
21. **AUTO ADJ. Button**
(→ page 32)
- 22, 23, 24. **COMPUTER 1/2/3 Button**
(→ page 21)
25. **VIDEO Button**
(→ page 21)
26. **S-VIDEO Button**
(→ page 21)
27. **HDMI Button**
(→ page 21)
28. **DisplayPort Button**
(→ page 21)
29. **VIEWER Button**
(→ page 21, 73)
30. **NETWORK Button**
(→ page 21)
31. **SLOT Button**
32. **ID SET Button**
(→ page 127)
33. **Numeric (0 to 9/CLEAR) Buttons**
(The AUX button will not work on this series of projectors.)
34. **CTL Button**
This button is used in conjunction with other buttons, similar to a CTRL key on a computer.
35. **LIGHT Button**
This button is used to turn on the backlight for the remote control buttons.
The backlight will turn off if no button operation is made for 10 seconds.
36. **HELP Button**
(→ page 133)

Battery Installation

1. Press the catch and remove the battery cover.
 2. Install new ones (AA). Ensure that you have the batteries' polarity (+/-) aligned correctly.
 3. Slip the cover back over the batteries until it snaps into place.
- NOTE: Do not mix different types of batteries or new and old batteries.*

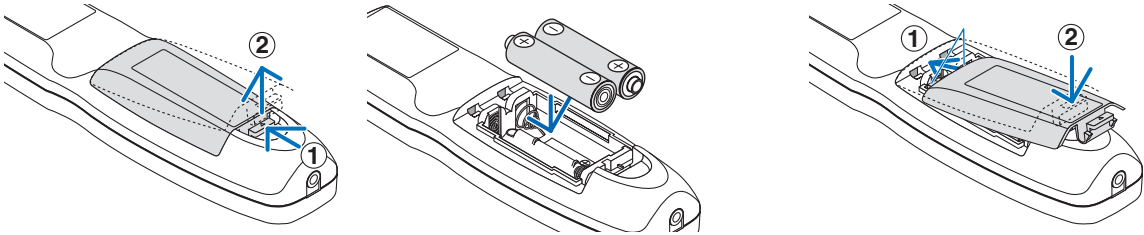

Remote Control Precautions

- Handle the remote control carefully.
- If the remote control gets wet, wipe it dry immediately.
- Avoid excessive heat and humidity.
- Do not short, heat, or take apart batteries.
- Do not throw batteries into fire.
- If you will not be using the remote control for a long time, remove the batteries.
- Ensure that you have the batteries' polarity (+/-) aligned correctly.
- Do not use new and old batteries together, or use different types of batteries together.
- Dispose of used batteries according to your local regulations.

Operating Range for Wireless Remote Control

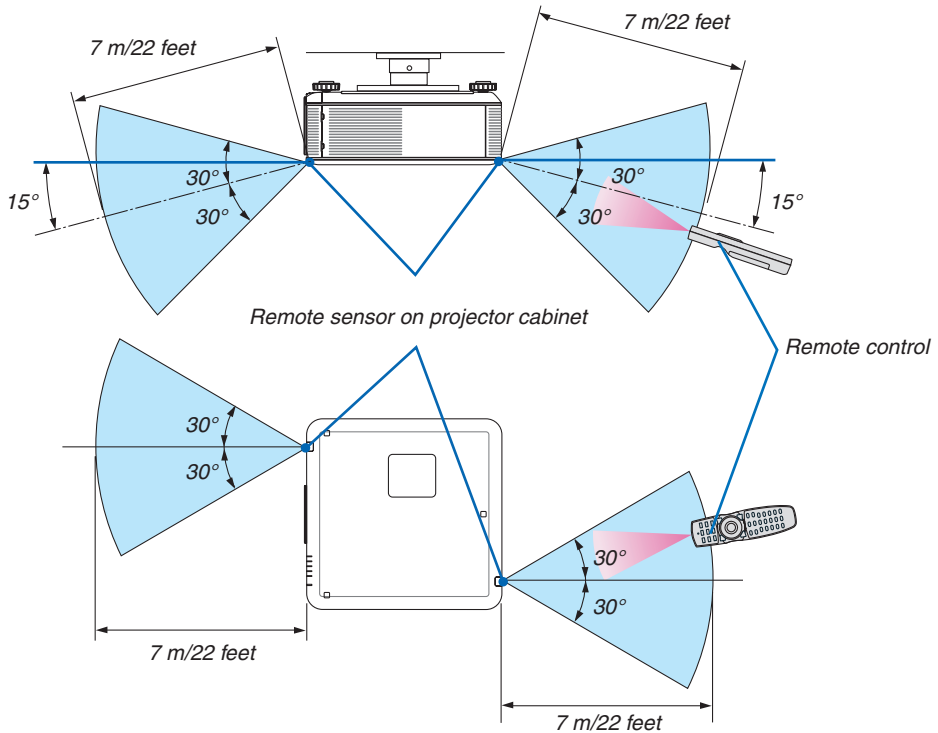

- The infrared signal operates by line-of-sight up to a distance of about 22 feet/7 m and within a 60-degree angle of the remote sensor on the projector cabinet.
- The projector will not respond if there are objects between the remote control and the sensor, or if strong light falls on the sensor. Weak batteries will also prevent the remote control from properly operating the projector.

Using the Remote Control in Wired Operation

Connect one end of the remote cable to the REMOTE mini jack and the other end to the remote jack on the remote control.

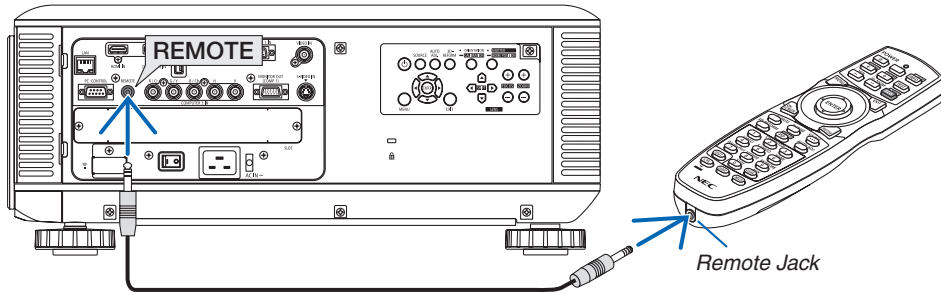

NOTE:

- When a remote cable is inserted into the REMOTE jack, the remote control does not work for infrared wireless communication.
 - When a remote cable is inserted into the REMOTE jack, the [POWER-SAVING] and [NORMAL2] functions in [STANDBY MODE] will not work.
 - Power will not be supplied to the remote control from the projector via the REMOTE jack. Battery is needed when the remote control is used in wired operation.
-

5 Operating Environment for Software Included on CD-ROM

Names and Features of Bundled Software Programs

Name of software program	Features
Image Express Utility 2.0	<ul style="list-style-type: none"> This is a software program used to send the screens of your personal computers to the projector via wired/wireless LAN (Meeting mode). Projected images can be transferred and saved to personal computers. When "Meeting Mode" is used, projected images can be sent and saved to the personal computers. Images can be sent from a personal computer to not only one projector but also to two or more projectors at the same time. (→ page 191)
PC Control Utility Pro 4	This is a software program used to operate the projector from the computer when the computer and the projector are connected with LAN (wired or wireless) or a serial cable. (→ page 202)
Image Express Utility for Mac	<ul style="list-style-type: none"> This is a software program used to send the Mac's screen image to the projector over a network (wired or wireless LAN). For Mac's operating environment, see page 203.

* A separately sold wireless LAN unit is required to use a wireless LAN.

NOTE:

- Image Express Utility for Mac does not support "Meeting Mode" which is provided in Image Express Utility 2.0.

The following software programs can be downloaded from our website.

Name of software program	Features
Virtual Remote Tool	When the computer and projector are connected using a network (wired/wireless LAN), such operations as turning the projector's power on and off and switching the signal can be performed. It is also possible to send an image to the projector and register it as the background logo. Once the image is registered, it can be locked to prevent the logo from being overwritten. (→ page 207)
Viewer PPT Converter 3.0	This is a software program used to convert files created with PowerPoint into JPEG files that can be displayed with the viewer function of the projector when a USB memory device is inserted into the projector. (→ page 210)

Download service

For downloading or updating these software programs, visit our website:

URL: <http://www.nec-display.com/dl/en/index.html>

Operating Environment

The following is the operating environment for Image Express Utility 2.0. For the operating environment of other software program, refer to the help function of each software program.

Supported OS	<p>Windows 7 Home Basic Windows 7 Home Premium Windows 7 Professional Windows 7 Ultimate Windows 7 Enterprise Windows Vista Home Basic Windows Vista Home Premium Windows Vista Business Windows Vista Ultimate Windows Vista Enterprise Windows XP Home Edition Service Pack 2 or later Windows XP Professional Service Pack 2 or later Windows XP Tablet PC Edition 2005 or later (Windows XP Tablet PC Edition Service Pack 2 or later)</p> <ul style="list-style-type: none"> • Only 32-bit version * “Easy Connection” supports the Administrative privileges of Windows XP and Windows 7/Windows Vista only • Windows power-saving function is not supported.
Processor	<ul style="list-style-type: none"> • Windows 7/Windows Vista Pentium 4/Pentium M 800 MHz equivalent or higher required Dual core 1 GHz or higher recommended • Windows XP Pentium III 800 MHz or higher required Pentium 4 1.6 GHz or higher recommended
Memory	<ul style="list-style-type: none"> • Windows 7/Windows Vista 512 MB or more required 1 GB or more recommended • Windows XP 128 MB or more required 192 MB or more recommended * More memory may be required to run additional applications simultaneously.
Graphic processor	<ul style="list-style-type: none"> • Windows 7/Windows Vista The “Graphics” score 3.0 or more of “Windows Experience Index” recommended.
Network environment	TCP/IP-compatible wired LAN or wireless LAN (* Use a wireless LAN unit complying with the Wi-Fi standard.)
Resolution	<ul style="list-style-type: none"> • Windows 7/Windows Vista SVGA (800 × 600) or higher required XGA (1024 × 768) recommended • Windows XP VGA (640 × 480) or higher required XGA (1024 × 768) recommended
Screen Colors	<p>High Color (15 bits, 16 bits) True Color (24 bits, 32 bits) (recommended)</p> <ul style="list-style-type: none"> • 256 or fewer colors are not supported.

2. Projecting an Image (Basic Operation)

This section describes how to turn on the projector and to project a picture onto the screen.

① Flow of Projecting an Image

Step 1

- *Connecting your computer / Connecting the supplied power cord* (→ [page 14](#))



Step 2

- *Turning on the projector* (→ [page 17](#))



Step 3

- *Selecting a source* (→ [page 21](#))



Step 4

- *Adjusting the picture size and position* (→ [page 22](#))
- *Correcting keystone distortion [KEYSTONE]* (→ [page 30](#))



Step 5

- *Adjusting a picture*
 - *Optimizing a computer signal automatically* (→ [page 32](#))



Step 6

- *Making a presentation*



Step 7

- *Turning off the projector* (→ [page 33](#))



Step 8

- *After use* (→ [page 34](#))

② Connecting Your Computer/Connecting the supplied Power Cord

NOTE:

- Install a lens before performing the following steps. (→ page 162)

1. Connect your computer to the projector.

This section will show you a basic connection to a computer. For information about other connections, see “(2) Making Connections” on page 164.

Connect the computer cable (VGA) between the projector’s COMPUTER 1 IN connector and the computer’s port (mini D-Sub 15 Pin). Turn two thumb screws of both connectors to fix the computer cable (VGA).

2. Connect the supplied power cord to the projector.

WARNING: TO PREVENT FIRE OR SHOCK, DO NOT EXPOSE THIS UNIT TO RAIN OR MOISTURE. DO NOT USE THIS UNIT’S PLUG WITH AN EXTENSION CORD OR IN AN OUTLET UNLESS ALL THE PRONGS CAN BE FULLY INSERTED.

Important Information:

- When plugging in or unplugging the supplied power cord, make sure that the main power switch is pushed to the off [O] position. Failure to do so may cause damage to the projector.
- Do not use a three-phase power supply. Doing so may cause malfunction.

First connect the supplied power cord’s three-pin plug to the AC IN of the projector, and then connect the other plug of the supplied power cord in the wall outlet.

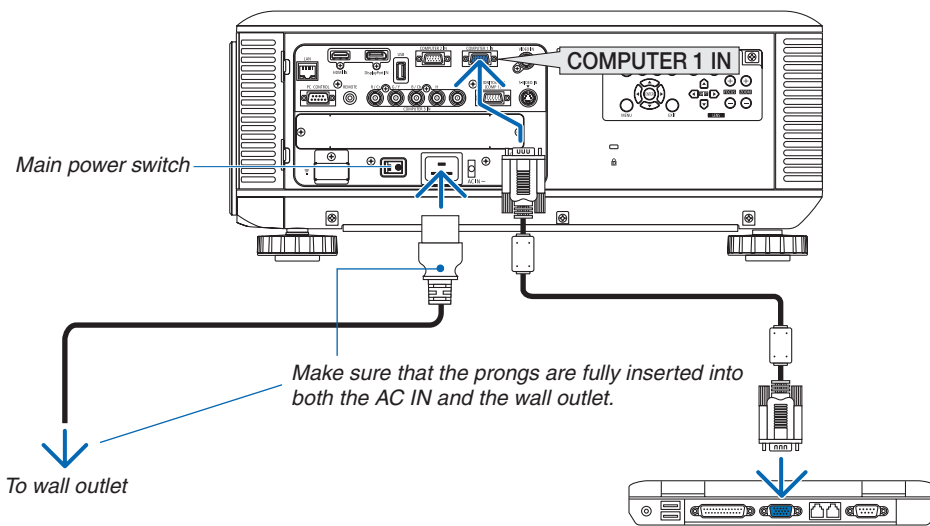

NOTE (for North America only)

- The model distributed in North America comes with two different types of power cords: one for 120V and the other for 200V. Use the power cord suitable for the voltage being used.

CAUTION:

Parts of the projector may become temporarily heated if the projector is turned off with the POWER button or if the AC power supply is disconnected during normal projector operation. Use caution when picking up the projector.

2. Projecting an Image (Basic Operation)

Using the Supplied Power Cord Stopper

To prevent the power cord from accidentally removing from the AC IN of the projector, attach the supplied power cord stopper to clamp the power cord.

NOTE:

- Do not clamp the power cord with other cables. Doing so can generate noise, which can affect adversely the signal cable.

⚠ CAUTION

- To prevent the power cord from coming loose, make sure that all the prongs of the power cord are fully inserted into the AC IN terminal of the projector before using the power cord stopper to fix the power cord. A loose contact of the power cord may cause a fire or electric shock.
- Do not bundle the power cord. Doing this could cause heat or a fire.
- Do not clamp two power cords that would be used when stacking two projectors. Doing this could cause a fire.

NOTE: Be careful not to insert the band inversely. Once the band is attached, it cannot be removed from the slot.

Attaching the power cord stopper

1. Insert the end of band of the power cord stopper into the slot next to the AC IN on the terminal panel.

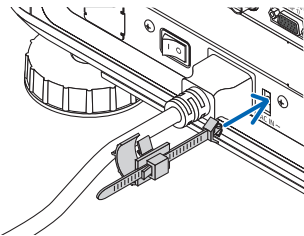

2. Use the power cord stopper to clamp the power cord.

Push the clamber to lock it.

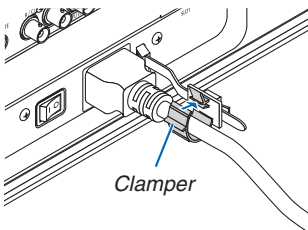

3. Slide the clamber to the hilt of the power cord.

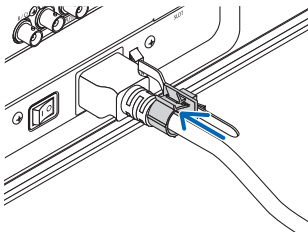

2. Projecting an Image (Basic Operation)

Removing the power cord from the power cord stopper

1. Push the clamber of the power cord stopper to unclasp it.

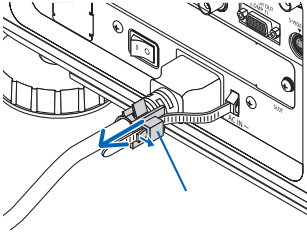

2. Push the power cord clamber to open it wide enough to pull out the power cord.

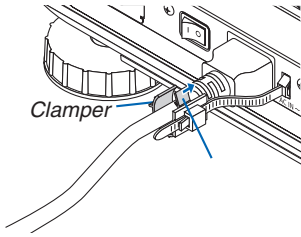

③ Turning on the Projector

NOTE:

- The projector has two power switches: A main power switch and a POWER button (POWER ON and OFF on the remote control)

• **Turning on the projector:**

1. **Press the main power switch to the ON position (I).**

The projector will go into standby mode.

2. **Press the POWER button .**

The projector will become ready to use.

• **Turning off the projector:**

1. **Press the POWER button.**

The confirmation message will be displayed.

2. **Press the POWER button again.**

The projector will go into standby mode.

3. **Press the main power switch to the OFF position (O).**

The projector will be turned off.

Remove the lens cap.

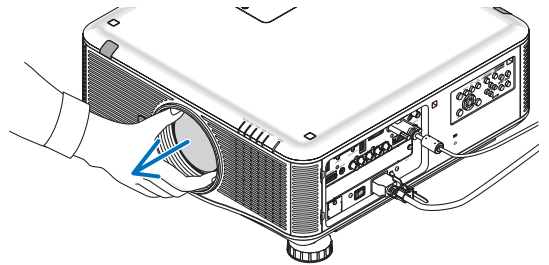

1. **Press the main power switch to the ON position (I).**

The projector will go into standby mode. When in standby mode, the POWER indicator will light orange and the STATUS indicator will light green when [NORMAL] is selected for [STANDBY MODE]. See the Power Indicator section. (→ page 229)

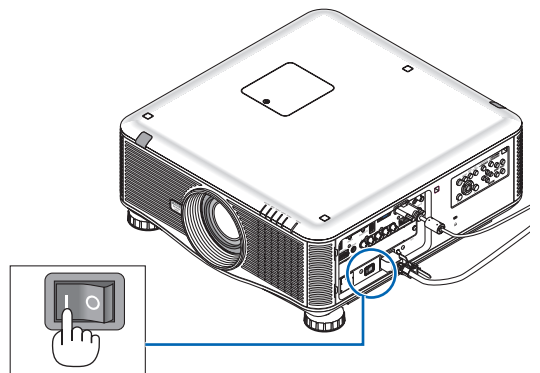

2. Projecting an Image (Basic Operation)

2. Press the (POWER) button on the projector cabinet or the POWER ON button on the remote control.

The POWER indicator will turn to blue and the projector will become ready to use.

TIP:

- When the message "PROJECTOR IS LOCKED! ENTER YOUR PASSWORD." is displayed, it means that the [SECURITY] feature is turned on. (→ page 44)
- When the ECO message is displayed, it means that [ON] is selected for [ECO MESSAGE]. (→ page 121)

After you turn on your projector, ensure that the computer or video source is turned on.

NOTE: The logo screen ([LOGO] background) is displayed when no signal is being input (by factory default menu settings).

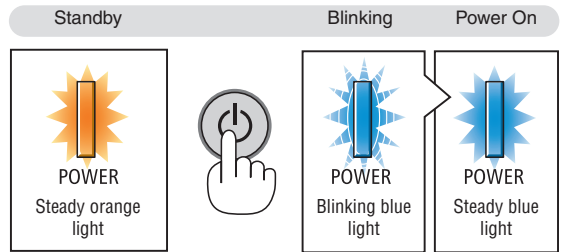
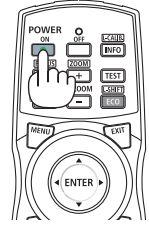
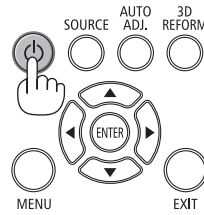

(→ page 229)

Performing Lens Calibration

After installation or replacement of the lens, be sure to perform [CALIBRATION] by pressing and holding the ORIENTATION button for at least two seconds or by holding the CTL button and pressing the INFO/L-CALIB button on the remote control. Calibration corrects the adjustable zoom and focus range. If calibration is not performed, you may not be able to get the best focus and zoom even if you adjust the focus and zoom for the lens.

- The following lenses need calibration:
NP16FL, NP17ZL, NP18ZL, NP19ZL, NP20ZL, NP21ZL, NP31ZL

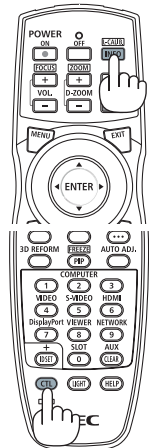
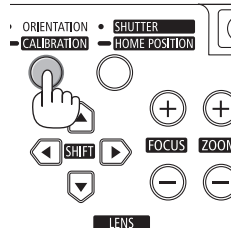

2. Projecting an Image (Basic Operation)

Note on Startup screen (Menu Language Select screen)

When you first turn on the projector, you will get the Startup menu. This menu gives you the opportunity to select one of the 27 menu languages.

To select a menu language, follow these steps:

1. Use the ▲, ▼, ◀ or ▶ button to select one of the 27 languages from the menu.

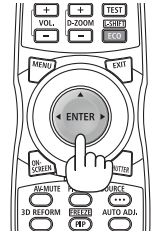
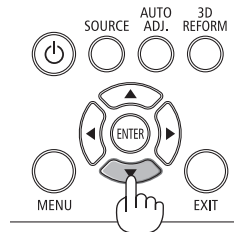

2. Press the ENTER button to execute the selection.

After this has been done, you can proceed to the menu operation.

If you want, you can select the menu language later.

(→ [LANGUAGE] on page 102 and 120)

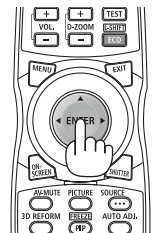
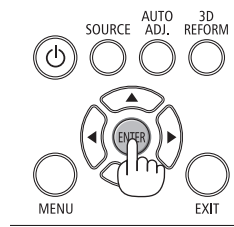

NOTE:

- Turning the power back on directly after it is turned off (by direct power off) while an image is being projected can result in malfunction. Be sure to wait at least 1 second before turning the power back on.
- Keep the lens cap off the lens while the projector's power is on.
If the lens cap is on, it could be warped due to high temperature.
- If one of the following things happens, the projector will not turn on.
 - If the internal temperature of the projector is too high, the projector detects abnormal high temperature. In this condition the projector will not turn on to protect the internal system. If this happens, wait for the projector's internal components to cool down.
 - Starting under low temperature conditions
If the usage environment temperature is lower than the projector's operating temperature, the TEMP. indicator will flash. Increase the usage environment temperature to 0°C or higher and turn on the projector again.
If you turn on the projector at around 0°C, it may take 5 minutes to warm up the projector.
During warm-up, the TEMP. indicator will flash. When the warm-up is completed, the TEMP. indicator will light out.
 - When the lamp reaches its end of usable life, the projector will not turn on. If this happens, replace the lamp.
 - If the STATUS indicator lights orange with the power button pressed, it means that the [CONTROL PANEL LOCK] is turned on. Cancel the lock by turning it off. (→ page 126)
 - If the lamp fails to light, and if the LAMP 1 or LAMP 2 indicator flashes on and off in a cycle of six times, wait a full minute and then turn on the power.
- While the POWER indicator is blinking blue in short cycles, the power cannot be turned off by using the power button.
- Immediately after turning on the projector, screen flicker may occur. This is normal. Wait 3 to 5 minutes until the lamp lighting is stabilized.
- When the projector is turned on, it may take some time before the lamp light becomes bright.
- If you turn on the projector immediately after the lamp is turned off or when the temperature is high, the fans run without displaying an image for some time and then the projector will display the image.

2. Projecting an Image (Basic Operation)

If the projected image is inverted or upside down

1 Press the ORIENTATION button.

The [ORIENTATION] screen will be displayed.

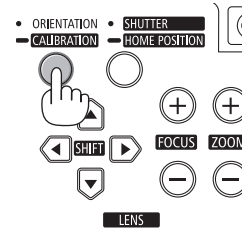

2 Press again to select a correct orientation.

Each time the ORIENTATION/CALIBRATION button is pressed, the choice you highlight will be changed.

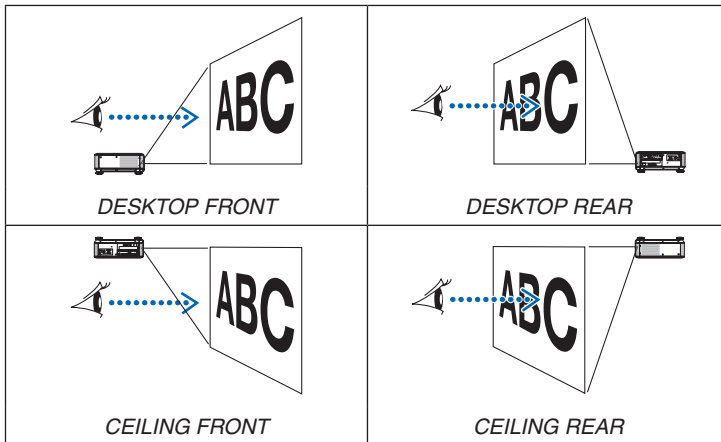

3 Stop pressing the ORIENTATION button.

The menu will be closed in about two seconds and the projected image will be displayed in the orientation you select.

A confirmation message will be also displayed.

4 Press the ENTER button.

The confirmation message will be closed.

4 Selecting a Source

Selecting the computer or video source

NOTE: Turn on the computer or video source equipment connected to the projector.

Detecting the Signal Automatically

Press the SOURCE button once. The projector will search for the available input source and display it. The input source will change as follows:

COMPUTER1 → COMPUTER2 → COMPUTER3 → HDMI → DisplayPort → VIDEO → S-VIDEO → VIEWER → SLOT → COMPUTER1 → ...

- With the SOURCE screen displayed, you can press the SOURCE button a few times to select the input source.

TIP: If no input signal is present, the input will be skipped.

Using the Remote Control

Press any one of the COMPUTER1, COMPUTER2, COMPUTER3, HDMI, DisplayPort, VIDEO, S-VIDEO, VIEWER, NETWORK, or SLOT buttons.

Selecting Default Source

You can set a source as the default source so that it will be displayed each time the projector is turned on.

1. Press the MENU button.

The menu will be displayed.

2. Press the ► button twice to select [SETUP] and press the ▼ button or the ENTER button to select [BASIC].

3. Press the ► button five times to select [OPTIONS(2)].

4. Press the ▼ button five times to select [DEFAULT SOURCE SELECT] and press the ENTER button.

The [DEFAULT SOURCE SELECT] screen will be displayed.

(→ page 131)

5. Select a source as the default source, and press the ENTER button.

6. Press the EXIT button a few times to close the menu.

7. Restart the projector.

The source you selected in step 5 will be projected.

NOTE: Even when [AUTO] is turned on, the [NETWORK] will not be automatically selected. To set your network as the default source, select [NETWORK].

TIP:

- When the projector is in Standby mode, applying a computer signal from a computer connected to the COMPUTER 1/3 IN input will power on the projector and simultaneously project the computer's image. ([AUTO POWER ON(COMP1/3)] → page 131)
- On the Windows 7 keyboard, a combination of the Windows and P keys allows you to set up external display easily and quickly.

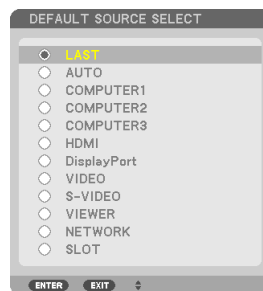
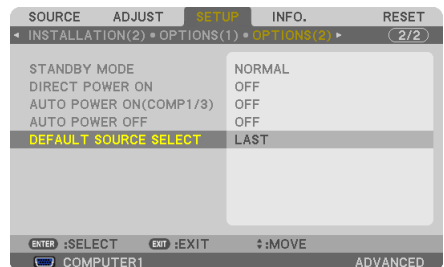
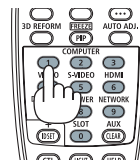
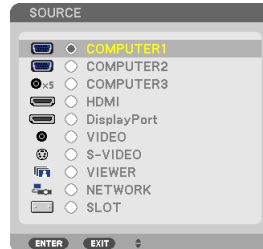
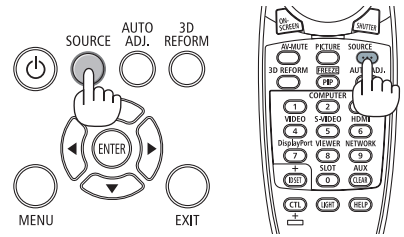

5 Adjusting the Picture Size and Position

Use the lens shift dial, the adjustable tilt foot lever, the zoom buttons and the focus buttons to adjust the picture size and position.

In this chapter drawings and cables are omitted for clarity.

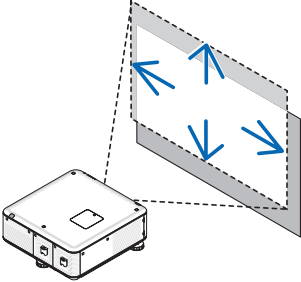
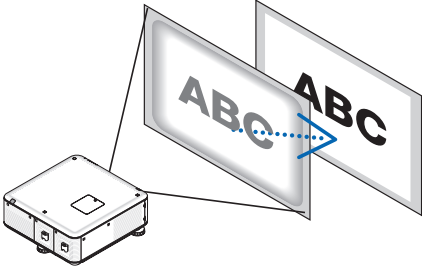
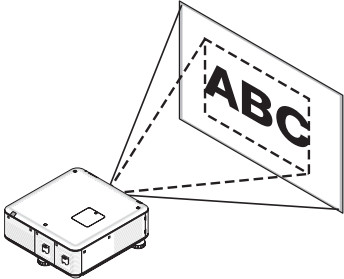
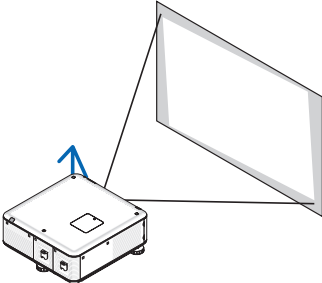
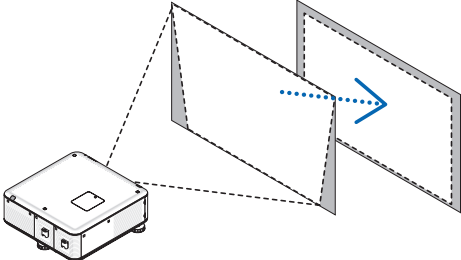
<p>Adjusting the projected image's vertical and horizontal position [Lens shift]</p>  <p>(→ page 23)</p>	<p>Adjusting the focus [Focus]</p>  <p>(→ page 25)</p>
<p>Finely adjusting the size of an image [Zoom]</p>  <p>(→ page 28)</p>	<p>Adjusting the projected image's height and horizontal tilt [Tilt foot] *1</p>  <p>(→ page 29)</p>
<p>Adjusting the keystone correction [Keystone]</p>  <p>(→ page 30)</p>	

NOTE*1: Adjust the projected image's height using the tilt feet when you want to project the image at a position higher than the lens shift adjustment range.

TIP:

- Built-in test patterns can be conveniently used for adjusting the picture size and position. (→ page 104)
A press of the TEST button will display the test pattern. The ◀ or ▶ button can select one test pattern. To close the test pattern, change the source to another.

2. Projecting an Image (Basic Operation)

Adjusting the vertical position of a projected image (Lens shift)

CAUTION

- Perform the adjustment from behind or from the side of the projector. Adjusting from the front could expose your eyes to strong light which could injure them.
- Keep hands away from the lens mounting portion while the lens shift is in operation. Failure to do so could result in hands being pinched by the moving lens.

NOTE:

- The lens shift function is not available on the projector with NP16FL (PX750U2) and NP06FL (PX700W2/PX800X2) lens installed. Return the lens shift position to the home position before installing the lens to the projector.
- Shifting the lens to the maximum in two directions combined will cause the edges of the image to become dark or will cause some shadows.

Adjusting with buttons on the cabinet

1. Press one of the LENS SHIFT ▼▲◀▶ buttons.

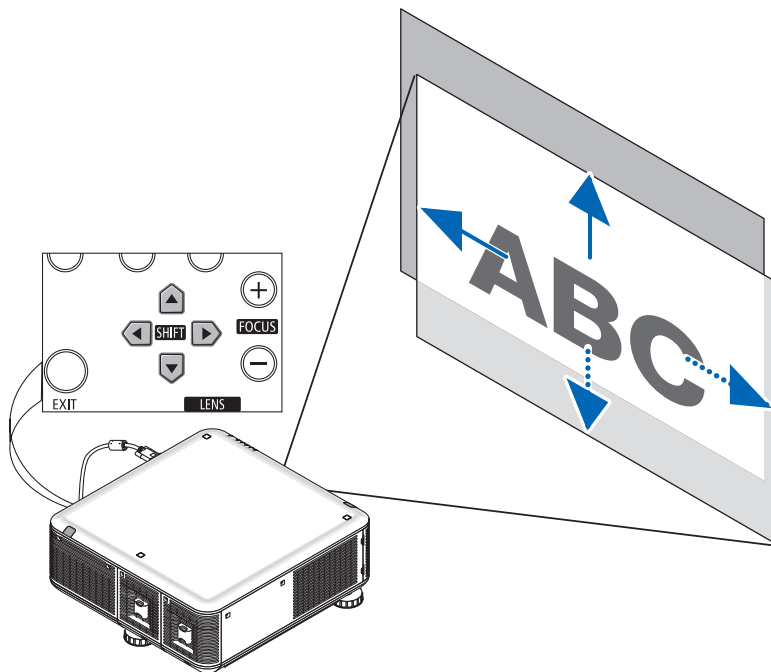

2. Use the LENS SHIFT ▼▲◀▶ buttons to move the projected image.

Returning the lens shift position to the home position

Press and hold the SHUTTER/HOME POSITION button for 2 seconds to return the lens shift position to the home position (nearly center position)

2. Projecting an Image (Basic Operation)

Adjusting with the remote control

1. Hold the CTL button and press the ECO/L-SHIFT button.

The Lens Shift screen will be displayed.

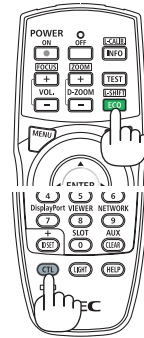
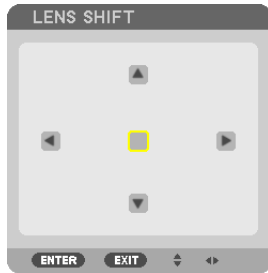

2. Press the ▼▲◀ or ▶ button.

Use the ▼▲◀▶ buttons to move the projected image.

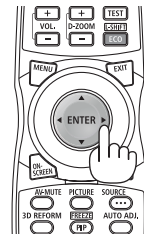

TIP:

- The diagram below shows the lens shift adjustment range for the desktop front. To raise the projection position higher than this, use the tilt feet. (→ page 29)
- For the ceiling mount/front projection lens shift adjustment range, see page 216.

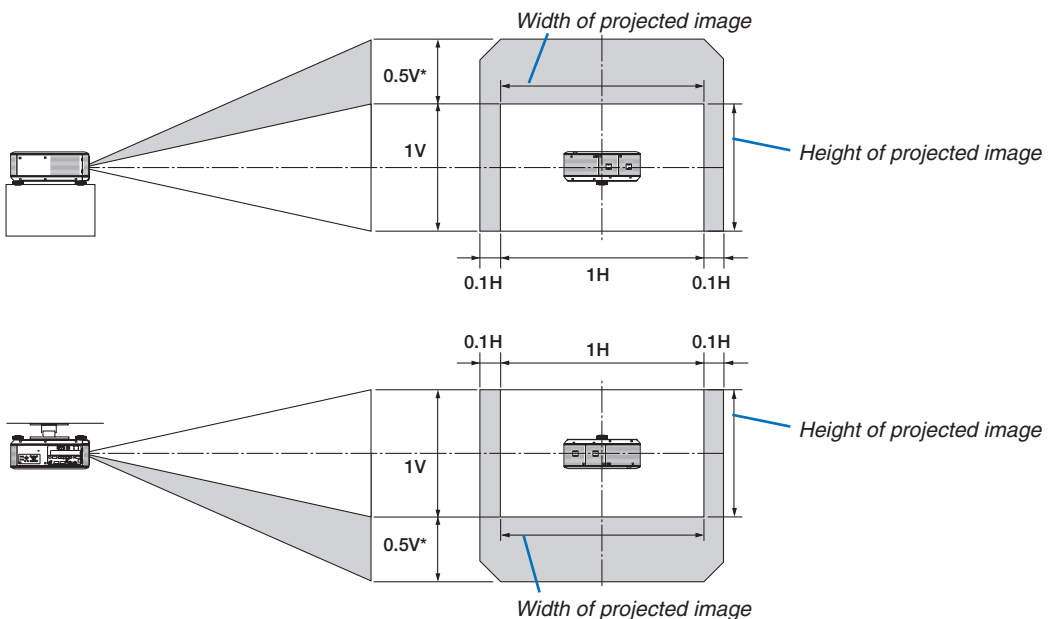

* For PX800X2, the value should be $0.43V$ on the NP31ZL lens.

2. Projecting an Image (Basic Operation)

Focus

Applicable lens:

- PX750U2: NP16FL/NP17ZL/NP18ZL/NP19ZL/NP20ZL/NP21ZL
- PX700W2/PX800X2: NP06FL/NP07ZL/NP08ZL/NP09ZL/NP10ZL

Use the FOCUS (+) or (-) button on the projector cabinet to obtain the best focus.

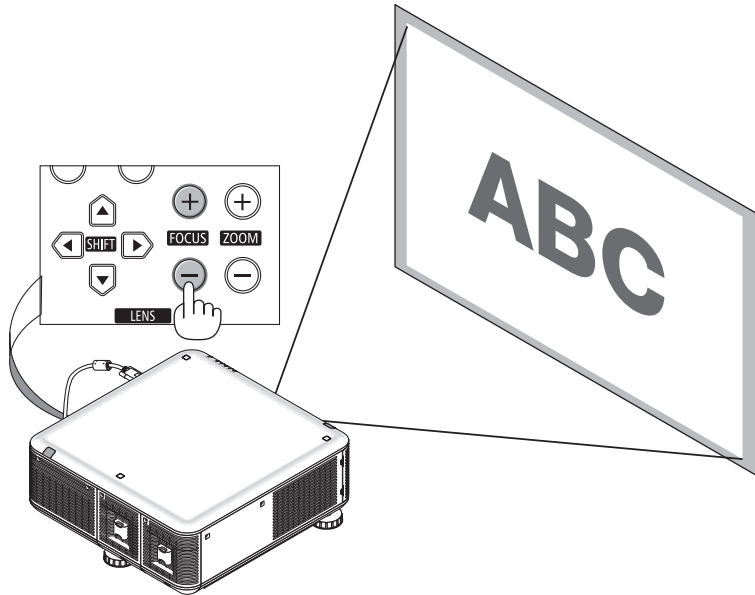

TIP: To obtain the best focus, perform the following (for fixed installation)

Preparation: Warm up the projector for one hour.

1. Use the FOCUS +/- buttons to make sure you obtain the best focus. If you do not, move the projector back and forth.
2. Select the [TEST PATTERN] from the menu and display the test pattern. (→ page 104)
 - You can also use the TEST button on the remote control to display the test pattern.
3. Keep pressing the FOCUS - button until the grid of the text pattern is made invisible.
4. Keep pressing the FOCUS + button until you obtain the best focus.
If you adjust beyond the best focal point, go back to step 3 and repeat the procedures.

Adjusting with the remote control

- Hold the CTL button and press the VOL/FOCUS +/- button.

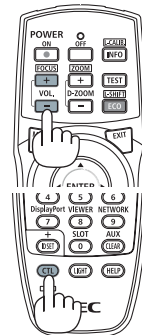

2. Projecting an Image (Basic Operation)

Applicable lens:

- PX750U2/PX700W2/PX800X2: NP31ZL

1. Focus on the projected image around the optical axis. (Powered focus)

The drawing below shows an example when the projected image is shifted upward. In this case the optical axis is at the bottom edge of the projected image.

Adjusting with buttons on the cabinet

Use the FOCUS (+) or (-) button on the projector cabinet.

Adjusting with the remote control

Hold the CTL button and press the VOL/FOCUS +/- button.

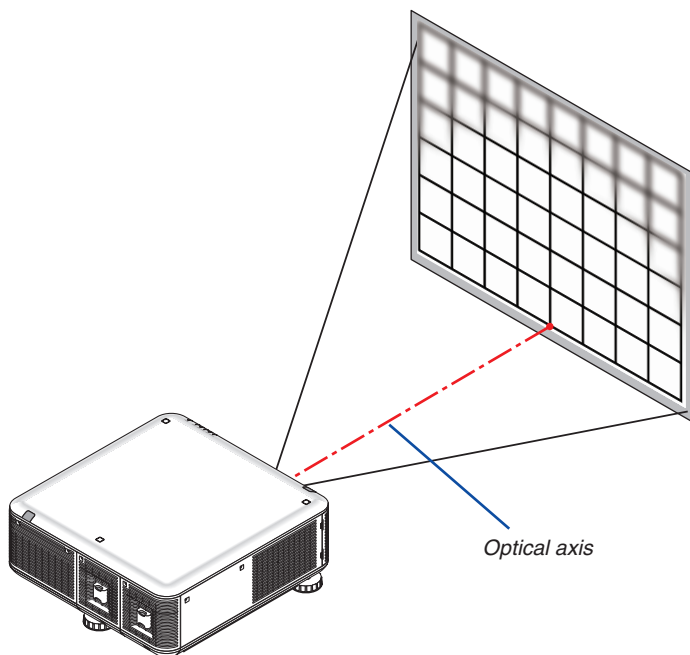
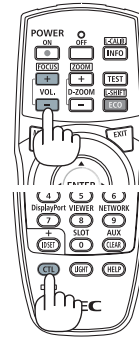
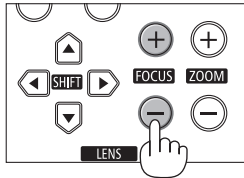

* With the lens shift in the center position the optical axis is at the center of the image. In this case, adjust the focus at the center of the projected image.

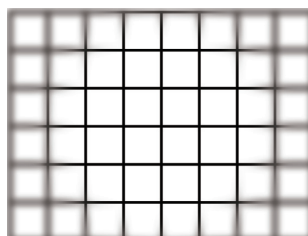

2. Projecting an Image (Basic Operation)

2. Adjust the focus at the edges of the projected image. (Manual focus)

Turn the edge focus ring clockwise or counterclockwise.

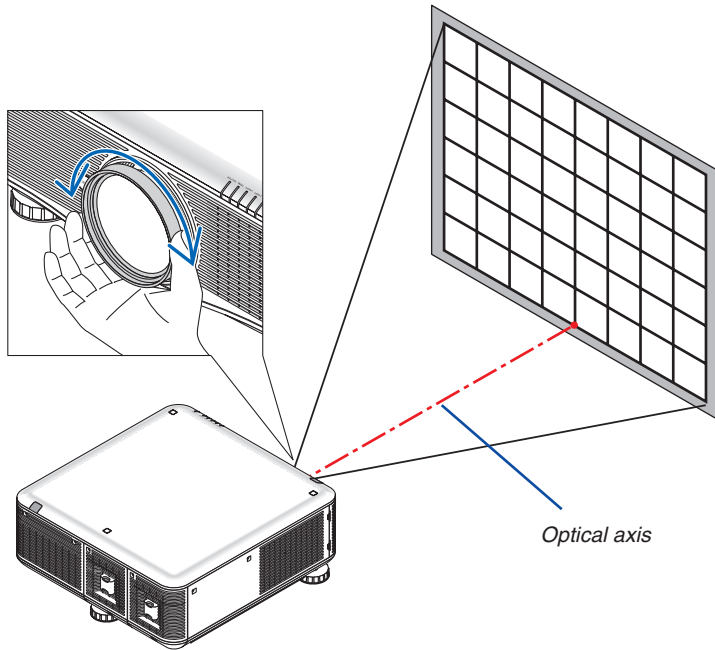

This completes adjusting the projected image's overall focus.

NOTE:

The NP31ZL supports the Lens Memory function, which allows you to store changes for Lens Shift, Zoom, and Focus.

If you accidentally move the Edge focus ring (drawing shown below) after having stored adjusted values, the adjusted values stored in the Lens Memory will not be correctly applied.

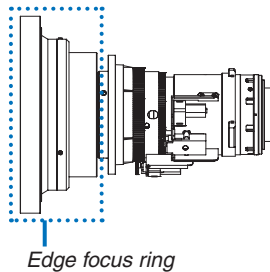

After having removed the lens from the projector and mounted it back, call up the adjusted values stored in the Lens Memory and then follow Step 2 in the procedure above to adjust the focus at the edges of the projected image again.

TIP: To obtain the best focus, perform the following (for fixed installation)

Preparation: Warm up the projector for one hour.

1. Use the FOCUS +/- buttons to make sure you obtain the best focus. If you do not, move the projector back and forth.
2. Select the [TEST PATTERN] from the menu and display the test pattern. (→ page 104)
 - You can also use the TEST button on the remote control to display the test pattern.
3. Keep pressing the FOCUS - button until the grid of the text pattern is made invisible.
4. Keep pressing the FOCUS + button until you obtain the best focus.
If you adjust beyond the best focal point, go back to step 3 and repeat the procedures.
5. Turn the edge focus ring clockwise or counterclockwise to adjust the focus at the edges of the projected image.

2. Projecting an Image (Basic Operation)

Zoom

Use the ZOOM (+) or (-) button on the projector cabinet to zoom in or out.

- The zoom is not available on the separately sold NP16FL (PX750U2) and NP06FL (PX700W2/PX800X2) lens.

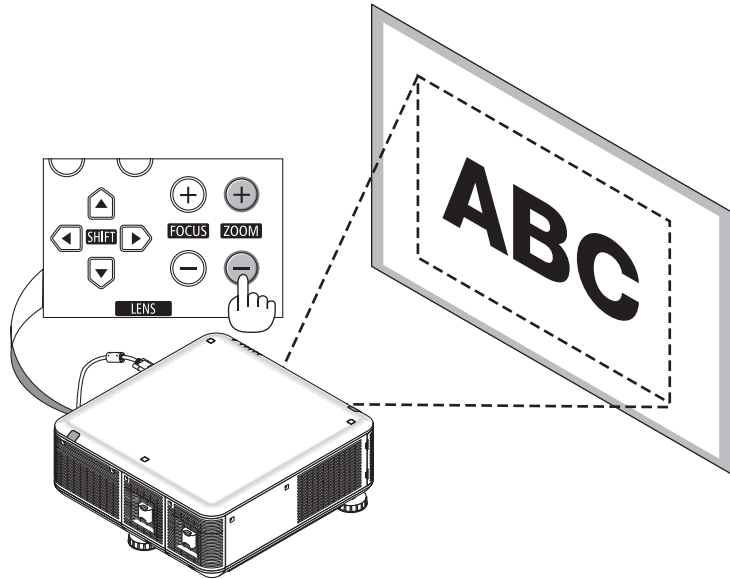

Adjusting with the remote control

- Hold the CTL button and press the D-ZOOM/ZOOM +/- button.

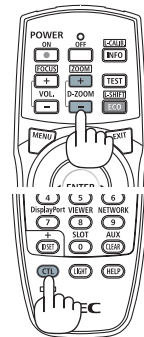

2. Projecting an Image (Basic Operation)

Adjusting the Tilt Feet

- Turn the left and right tilt feet on the right, left, and rear to adjust.

The tilt feet lengthen and shorten when turned.

The height of the projected image is adjusted by turning the left and right tilt feet.

If the projected image is tilted, turn one of the tilt feet to adjust the image so that it is level.

- If the projected image is distorted, see "2-6 Correcting Keystone Distortion" (→ page 30).
- The tilt feet can be used to tilt +/- 50 mm/1.97" (6.75°), -9 mm/0.35" (1.2°).

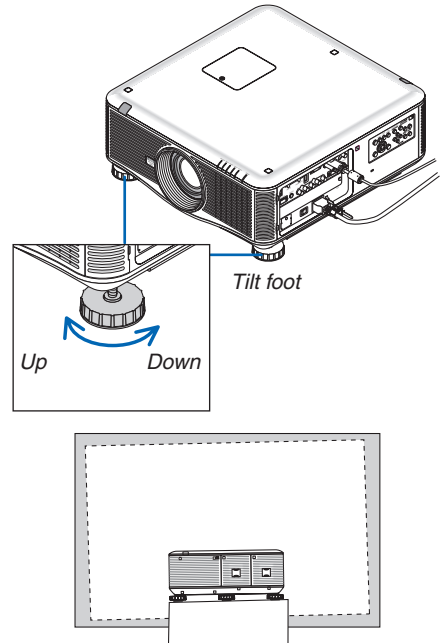

CAUTION

The rear vents of the projector may become heated during normal projector operation.
Use caution when adjusting the tilt foot on the rear side.

NOTE:

- Do not lengthen the tilt feet on the right and left any more than 50 mm/1.97" and the tilt foot on the rear any more than 9 mm/0.35" on the rear. The force of doing so may cause the rear foot to come off, resulting in damage to the projector.
- Do not use the tilt feet for any purpose other than adjusting the projector's projection angle.
Handling the tilt feet improperly, such as carrying the projector by grasping the tilt feet or hooking it onto a wall using the tilt feet, could damage the projector.

6 Correcting Keystone Distortion

When the projector is not exactly perpendicular to the screen, keystone distortion occurs. To overcome it, you can use the “Keystone” function, a digital technology that can adjust for keystone-type distortion, resulting in a crisp, square image. The following procedure explains how to use the [KEystone] screen from the menu to correct trapezoidal distortions. When the projector is placed diagonally to the screen,

When the projector is set up at an angle in relation to the screen, adjust the Horizontal option of the Keystone menu so that the top and bottom of sides of the projected image are parallel.

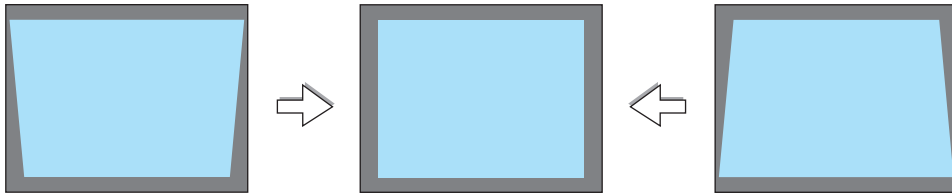

1. Press the 3D REFORM button on the remote control or the projector cabinet.

The Keystone screen will be displayed on the screen.

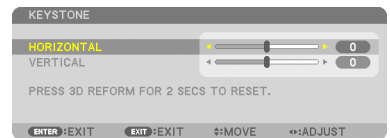

2. Press the ▼ button to select [VERTICAL] and then use the ◀ or ▶ so that the left and right sides of the projected image are parallel.

* Adjust the vertical keystone distortion.

3. Align the left (or right) side of the screen with the left (or right) side of the projected image.

- Use the shorter side of the projected image as the base.
- In the right example, use the left side as the base.

4. Press the ▲ button to select [HORIZONTAL] and then use the ◀ or ▶ so that the top and bottom sides of the projected image are parallel.

- Adjust the horizontal keystone distortion.

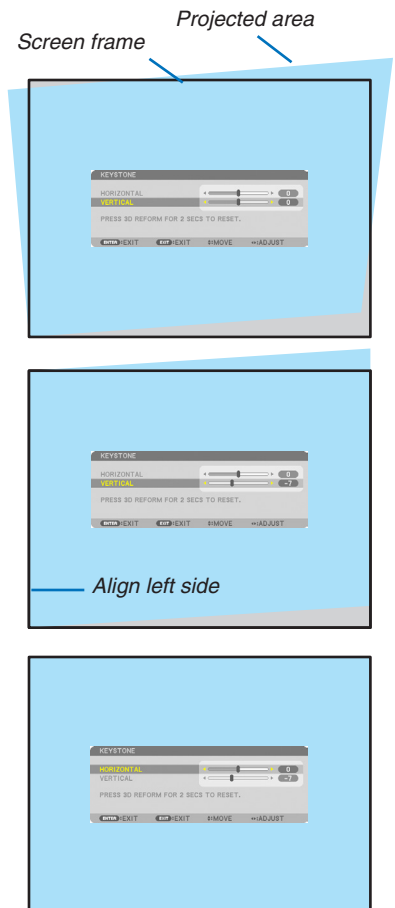

2. Projecting an Image (Basic Operation)

5. Repeat steps 2 and 4 to correct keystone distortion.

6. After completing Keystone correction, press the EXIT button.

The Keystone screen will disappear.

- To perform Keystone correction again, press the 3D REFORM button to display the Keystone screen and repeat above steps 1 to 6.



NOTE:

- If the projection angle is the same as in the last use, the previous correction setting values are retained in the memory.
 - When doing Step 2, adjust the position of image so that the screen is smaller than the area of the projected area.
 - To reset the 3D Reform correction setting values, press and hold the 3D REFORM button for a minimum of 2 seconds.
 - Each time the 3D REFORM button is pressed, the item will change as follows: KEYSTONE → CORNERSTONE → None → KEYSTONE → ...
For information on [CORNERSTONE], see “Correcting Horizontal and Vertical Keystone Distortion (Cornerstone)” on page 39.
 - The Cornerstone adjustment will not be available during the Keystone adjustment. To perform the Cornerstone adjustment, press and hold the 3D REFORM button for a minimum of 2 seconds to reset the Keystone correction setting values. The Keystone adjustment will not be available during the Cornerstone adjustment. To perform the Keystone adjustment, press and hold the 3D REFORM button for a minimum of 2 seconds to reset the Cornerstone correction setting values.
 - The 3D Reform feature can cause an image to be slightly blurred because the correction is made electronically.
-

⑦ Optimizing Computer Signal Automatically

Adjusting the Image Using Auto Adjust

Optimizing a computer image automatically. (COMPUTER1/COMPUTER2/COMPUTER3)

Press the AUTO ADJ. button to optimize a computer image automatically.

This adjustment may be necessary when you connect your computer for the first time.

[Poor picture]

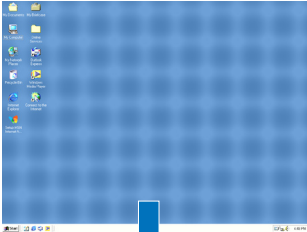

[Normal picture]

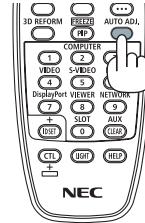
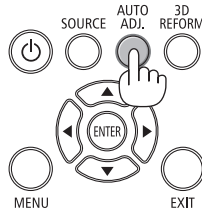
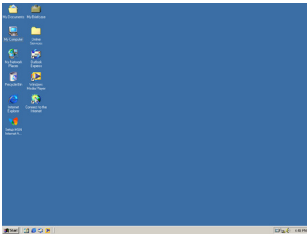

NOTE:

Some signals may take time to display or may not be displayed correctly.

- If the Auto Adjust operation cannot optimize the computer signal, try to adjust [HORIZONTAL], [VERTICAL], [CLOCK], and [PHASE] manually. (→ page 111, 112)
-

8 Turning off the Projector

To turn off the projector:

1. First, press the  (POWER) button on the projector cabinet or the POWER OFF button on the remote control.

The [POWER OFF / ARE YOU SURE ? / CARBON SAVINGS- SESSION 0.000[g-CO2]] message will appear.

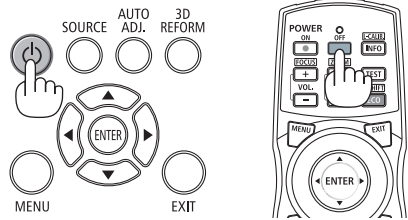
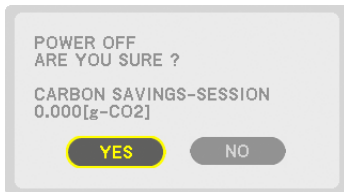

2. Secondly, press the ENTER button or press the  (POWER) or the POWER OFF button again.

The lamp will turn off and the projector will go into standby mode. When in standby mode, the POWER indicator will light orange and the STATUS indicator will light green when [NORMAL] is selected for [STANDBY MODE].

3. Press the main power switch to the OFF position (O).

The POWER indicator will go off and the main power will turn off.

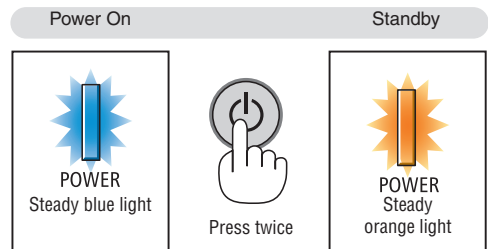

CAUTION:

Parts of the projector may become temporarily heated if the projector is turned off with the POWER button or if the AC power supply is disconnected during normal projector operation. Use caution when picking up the projector.

NOTE:

- While the POWER indicator is blinking blue in short cycles, the power cannot be turned off.
- You cannot turn off the power for 60 seconds immediately after turning it on and displaying an image.
- Wait at least 20 minutes after the power is turned on (after starting to project) before turning the AC power off while an image is being projected or while the cooling fan is running.
- Do not unplug the power cord from the projector or from the power outlet while an image is being projected. Doing so could deteriorate the projector's AC input connector or the power plug's contact. To turn off the AC power while an image is being projected, use the projector's main power switch, the power strip's switch, the breaker, etc.
- Do not disconnect the AC power supply to the projector within 10 seconds of making adjustment or setting changes and closing the menu. Doing so can cause loss of adjustments and settings.

9 After Use

Preparation: Make sure that the projector is turned off.

1. *Unplug the power cord.*
2. *Disconnect any other cables.*
 - *Remove the USB memory if it is inserted into the projector.*
3. *Mount the lens cap on the lens.*
4. *Before moving the projector, screw in the tilt feet if they have been lengthened.*

3. Convenient Features

1 Blocking the lamp light (LENS SHUTTER)

Press the SHUTTER/HOME POSITION button to block the lamps light from hitting the screen. Press again to allow the screen to become illuminated again.

- Another way to shut the lamp light off is to press the SHUTTER button on the remote control.

NOTE:

- Do not press and hold the SHUTTER/HOME POSITION button for 2 seconds or longer.
Doing so will cause the lens shift position to return to the home position.

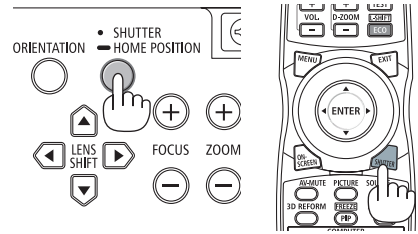

2 Turning off the Image

Press the AV-MUTE button to turn off the image for a short period of time. Press again to restore the image.

The projector's power-saving function will work in some seconds after the image is turned off. As a result, the lamp power will be reduced.

NOTE:

- To restore the image, even if you press the AV-MUTE button immediately after the start of the power-saving function, the lamp brightness may not be restored to its original level.

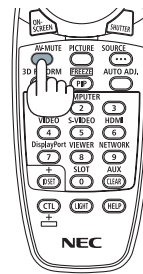

3 Turning Off the On-Screen Menu (On-Screen Mute)

A press of the ON-SCREEN button on the remote control will hide the on-screen menu, the source display and other messages. Press again to restore them.

TIP:

- To confirm that the on-screen mute is turned on, press the MENU button. If the on-screen menu is not displayed even though you press the MENU button, it means the on-screen mute is turned on.
- The on-screen mute is maintained even when the projector is turned off,
- Holding down the MENU button for at least 10 seconds will turn off the on-screen mute.

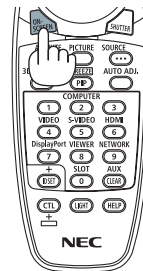

4 Freezing a Picture

Hold the CTL button and press the PIP/FREEZE button to freeze a picture. Press again to resume motion.

NOTE: The image is frozen but the original video is still playing back.

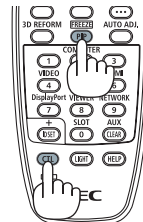

5 Enlarging a Picture

You can enlarge the picture up to four times.

NOTE: The maximum magnification may be less than four times depending on the signal.

To do so:

1. Press the D-ZOOM/ZOOM (+) button to magnify the picture.

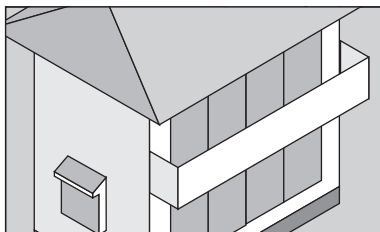
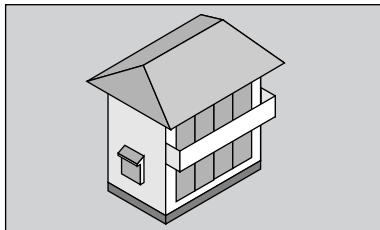

2. Press the ▲▼◀▶ button.

The area of the magnified image will be moved

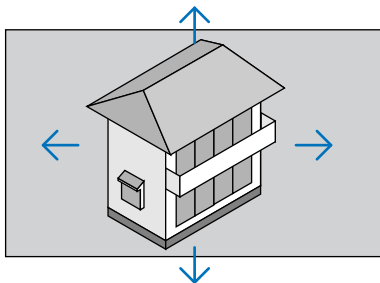

3. Press the D-ZOOM/ZOOM (-) button.

Each time the D-ZOOM/ZOOM (-) button is pressed, the image is reduced.

NOTE:

- The image will be enlarged or reduced at the center of the screen.
- Displaying the menu will cancel the current magnification.



⑥ Changing Eco Mode/Checking Energy-Saving Effect Using Eco Mode [ECO MODE]

This feature enables you to select two brightness modes of the lamp: OFF and ON modes. The lamp life can be extended by turning on the [ECO MODE].

[ECO MODE]	Description
[OFF]	This is the default setting (100% Brightness).
[ON] 	Low lamp power consumption (approx. 80% Brightness).

To turn on the [ECO MODE], do the following:

1. **Press the ECO/L-SHIFT button on the remote control to display [ECO MODE] screen.**
2. **Use the ▲ or ▼ button to select [ON].**
3. **Press the ENTER button.**

To change from [ON] to [OFF], Go back to Step 2 and select [OFF]. Repeat Step 3.

NOTE:

- The [ECO MODE] can be changed by using the menu.
Select [SETUP] → [BASIC] → [LAMP MODE] → [ECO MODE].
 - The lamp life remaining and lamp hours used can be checked in [USAGE TIME]. Select [INFO.] → [USAGE TIME].
 - [ECO MODE] is always set to [OFF] immediately after the lamp is turned on. The lamp condition will not be affected even when [ECO MODE] is changed.
 - After a lapse of 1 minute from when the projector displays a blue, black or logo screen, [ECO MODE] will automatically switch to [ON].
-

Checking Energy-Saving Effect [CARBON METER]

This feature will show energy-saving effect in terms of CO₂ emission reduction (kg) when the projector's [ECO MODE] is set to [OFF], or [ON]. This feature is called as [CARBON METER].

There are two messages: [TOTAL CARBON SAVINGS] and [CARBON SAVINGS-SESSION]. The [TOTAL CARBON SAVINGS] message shows the total amount of CO₂ emission reduction from the time of shipment up to now. You can check the information on [USAGE TIME] from [INFO.] of the menu. (→ page 133)

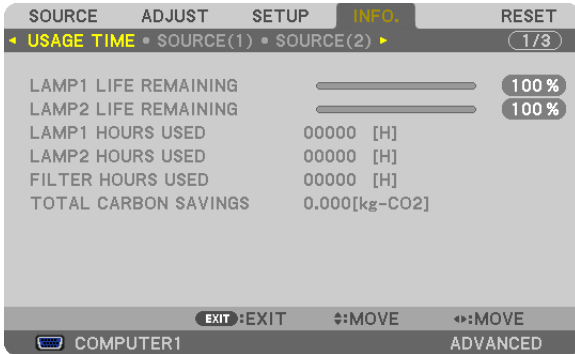

The [CARBON SAVINGS-SESSION] message shows the amount of CO₂ emission reduction between the time of changing to ECO MODE immediately after the time of power-on and the time of power-off. The [CARBON SAVINGS-SESSION] message will be displayed in the [POWER OFF/ ARE YOU SURE ?] message at the time of power-off.

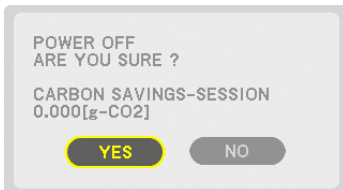

TIP:

- The formula as shown below is used to calculate the amount of CO₂ emission reduction.

$$\text{Amount of CO}_2 \text{ emission reduction} = (\text{Power consumption in OFF for ECO MODE} - \text{Power consumption in ON for ECO MODE}) \times \text{CO}_2 \text{ conversion factor.}$$
 * When the image is turned off, the amount of CO₂ emission reduction will also increase.
 * Calculation for amount of CO₂ emission reduction is based on an OECD publication "CO₂ Emissions from Fuel Combustion, 2008 Edition".
- The [TOTAL CARBON SAVINGS] is calculated based on savings recorded in 15 minutes intervals.
- This formula will not apply to the power consumption which is not affected by whether [ECO MODE] is turned on or off.

7 Correcting Horizontal and Vertical Keystone Distortion [CORNERSTONE]

Use the 3D Reform feature to correct keystone (trapezoidal) distortion to make the top or bottom and the left or right side of the screen longer or shorter so that the projected image is rectangular.

Cornerstone

1. Press and hold the 3D REFORM button for a minimum of 2 seconds to reset current adjustments.

Current adjustments for [KEystone] or [CORNERSTONE] will be cleared.

2. Project an image so that the screen is smaller than the area of the raster.

3. Pick up any one of the corners and align the corner of the image with a corner of the screen.

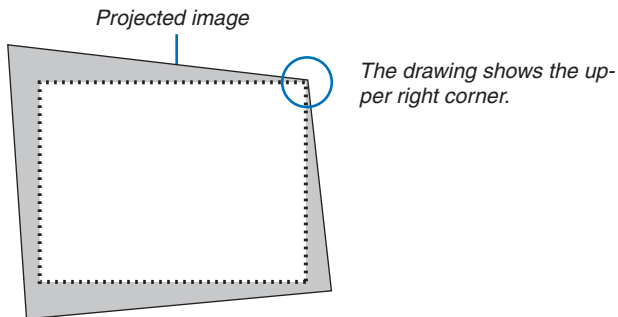

4. Press the 3D REFORM button twice.

The Cornerstone adjustment screen is displayed.

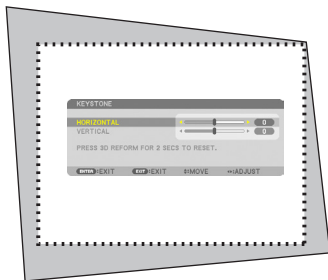

The drawing shows the upper left icon (▼) is selected.

TIP: If you are adjusting [KEYSTONE], [CORNERSTONE] will not be available. If this happens, press and hold the 3D REFORM button for a minimum of 2 seconds to reset the [KEYSTONE] adjustments.

5. Use the ▲▼◀▶ button to select one icon (▲) which points in the direction you wish to move the projected image frame.

6. Press the ENTER button.

7. Use the ▲▼◀▶ button to move the projected image frame as shown on the example.

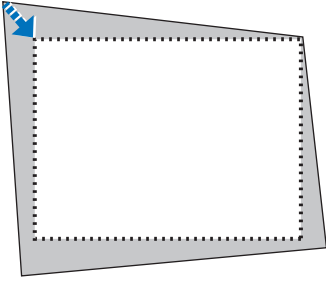

8. Press the ENTER button.

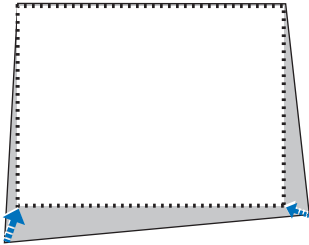

9. Use the ▲▼◀▶ button to select another icon which points in the direction.

On the Cornerstone adjustment screen, select [EXIT] or press the EXIT button on the remote control.



The confirmation screen is displayed.

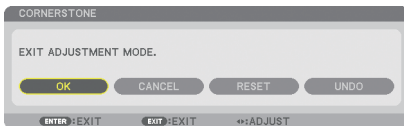

10. Press the ◀ or ▶ button to highlight the [OK] and press the ENTER button.

This completes the Cornerstone correction.

Selecting [CANCEL] will return to the adjustment screen without saving changes (Step 3).

Selecting [RESET] will return to the factory default.

Selecting [UNDO] will exit without saving changes.

NOTE: To reset the 3D Reform correction setting values, press and hold the 3D REFORM button for a minimum of 2 seconds.

3. Convenient Features

The adjustable ranges for 3D Reform are as follows:

	HORIZONTAL	VERTICAL
CORNERSTONE	PX750U2: Max. +/- 35° approx.	Max. +/- 30° approx.
KEYSTONE	PX700W2/PX800X2: Max. +/-40° approx.	

* The following are conditions under which the maximum angle is achieved:

- When the NP18ZL (PX750U2) and NP08ZL (PX700W2/PX800X2) lens is used

- When the lens shift is set to the center

When the lens shift is used and yet the image is not displayed in the center of the screen, the adjustable range will be increased or decreased.

- Image is projected in maximum wide with the zoom

NOTE:

- Even when the projector is turned on, the last used correction values are applied.
 - If the Cornerstone screen is unavailable (grayed), press and hold the 3D REFORM button for a minimum of 2 seconds to reset the current correction data. The Cornerstone function becomes available.
 - Turning on the projector will reset the previous correction setting values and correct distortion anew if the projection angle is changed from the last use.
If the projection angle is the same as in the last use, the previous correction setting values are retained in the memory.
 - The range of keystone correction is not the maximum tilt angle of projector.
-

NOTE: Using 3D Reform correction can cause the image to be slightly blurred because the correction is made electronically.

8 Displaying Two Pictures at the Same Time

The projector has a feature that allows you to view two different signals simultaneously. You have two modes: PIP mode and PICTURE BY PICTURE mode.

- From the menu you can select [SETUP] → [BASIC] → [PIP/PICTURE BY PICTURE].

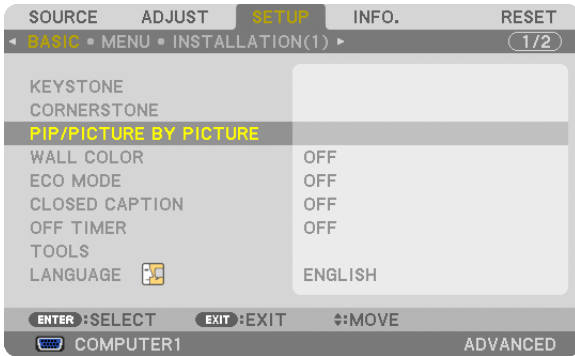

The [PIP/PICTURE BY PICTURE] menu item has the following three options: MODE, POSITION, and SOURCE. Use the ▲ or ▼ button to select [MODE], [POSITION] or [SOURCE] and press the ENTER button.

Selecting the PIP or PICTURE BY PICTURE Mode [MODE]

This option allows you to select two modes: PIP and PICTURE BY PICTURE.

Use the ▲ or ▼ button to select [PIP] or [PICTURE BY PICTURE] and press the ENTER button.

PIP: This option allows you to view a sub picture in the main picture.

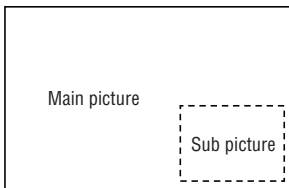

PICTURE BY PICTURE: This allows you to view two pictures side by side.

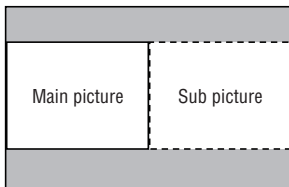

NOTE:

- The main picture will be displayed on the left side and the sub picture on the right side.
- The main picture signal supports the COMPUTER 1, COMPUTER 2, and COMPUTER 3 connectors. The sub picture signal supports the VIDEO IN and S-VIDEO IN connectors.
- The main picture supports an RGB signal with a resolution of 1280 × 1024 pixels or less.

Viewing Two Pictures

1. Press the PIP/FREEZE button on the remote control.

The PIP/PBP SOURCE screen will be displayed.



2. Use the ▲ or ▼ button to select the source and press the ENTER button.

The PIP screen or PICTURE BY PICTURE screen will be displayed, depending on which was selected in the [MODE] setting screen.

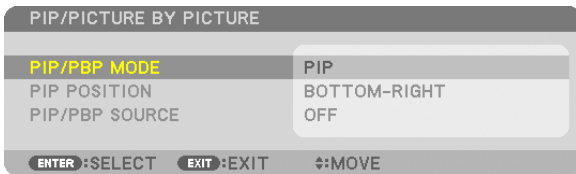

3. Press the PIP/FREEZE button again to return to the normal screen (single picture).

TIP:

- Selecting another source will return to the normal screen.
- Selecting a source not supported for the main picture or the sub picture will return to the normal screen.

[POSITION]

This option allows you to select the position of a sub picture in the main picture.

NOTE:

- The default setting is [BOTTOM-RIGHT].



Use the ▲ or ▼ button to select the sub picture's position and press the ENTER button. The options are: TOP-LEFT, TOP-RIGHT, BOTTOM-LEFT, and BOTTOM-RIGHT.

The following adjustments and settings are available for the main picture only.

- Adjusting picture
- Magnifying a picture with the D-ZOOM/ZOOM +/- button.

The following operations are available for both the main and sub pictures.

- Picture mute
- Freezing a moving picture

9 Preventing the Unauthorized Use of the Projector [SECURITY]

A keyword can be set for your projector using the Menu to avoid operation by an unauthorized user. When a keyword is set, turning on the projector will display the Keyword input screen. Unless the correct keyword is entered, the projector cannot project an image.

- The [SECURITY] setting cannot be cancelled by using the [RESET] of the menu.

To enable the Security function:

1. Press the MENU button.

The menu will be displayed.

2. Press the ► button twice to select [SETUP] and press the ▼ button or the ENTER button to select [BASIC].

3. Press the ► button to select [INSTALLATION(2)].

4. Press the ▼ button three times to select [SECURITY] and press the ENTER button.

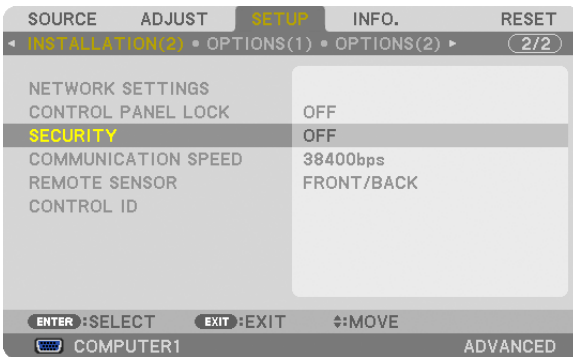

The OFF/ON menu will be displayed.

5. Press the ▼ button to select [ON] and press the ENTER button.

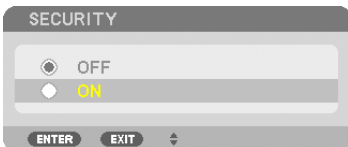

The [SECURITY KEYWORD] screen will be displayed.

6. Type in a combination of the four ▲▼◀▶ buttons and press the ENTER button.

NOTE: A keyword must be 4 to 10 digits in length.

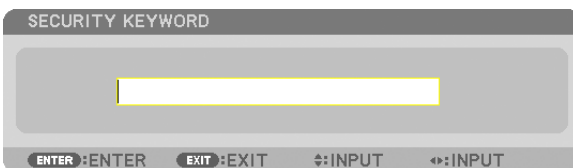

The [CONFIRM KEYWORD] screen will be displayed.

NOTE: Make a note of your password and store it in a safe place.

7. Type in the same combination of ▲▼◀▶ buttons and press the ENTER button.

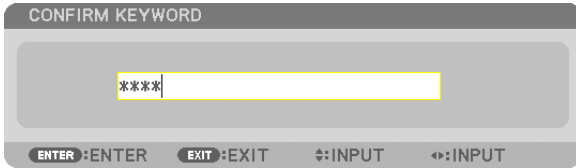

The confirmation screen will be displayed.

8. Select [YES] and press the ENTER button.



The SECURITY function has been enabled.

To turn on the projector when [SECURITY] is enabled:

1. Press the POWER button.

The projector will be turned on and display a message to the effect that the projector is locked.

2. Press the MENU button.

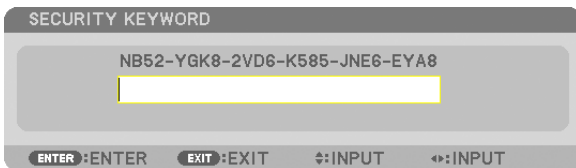

3. Type in the correct keyword and press the ENTER button. The projector will display an image.



NOTE: The security disable mode is maintained until the main power is turned off or unplugging the power cord.

To disable the SECURITY function:

1. Press the MENU button.

The menu will be displayed.

2. Select [SETUP] → [INSTALLATION(2)] → [SECURITY] and press the ENTER button.

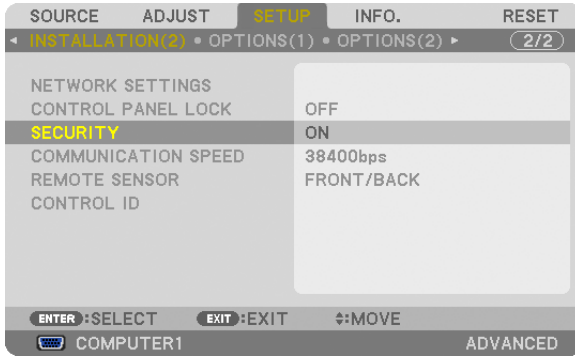

The OFF/ON menu will be displayed.

3. Select [OFF] and press the ENTER button.



The SECURITY KEYWORD screen will be displayed.

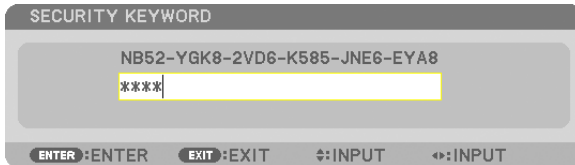

4. Type in your keyword and press the ENTER button.

When the correct keyword is entered, the SECURITY function will be disabled.

NOTE: If you forget your keyword, contact your dealer. Your dealer will provide you with your keyword in exchange for your request code. Your request code is displayed in the Keyword Confirmation screen. In this example [NB52-YGK8-2VD6-K585-JNE6-EYA8] is a request code.

⑩ Storing Changes for Lens Shift, Zoom, and Focus [LENS MEMORY]

The adjusted values can be stored in projector memory when using the LENS SHIFT, ZOOM and FOCUS buttons of the projector. Adjusted values can be applied to the signal you selected. This will eliminate the need to adjust lens shift, focus, and zoom at the time of source selection. There are two ways to save adjusted values for lens shift, zoom, and focus.

Function name	Description	page
REF. LENS MEMORY	Adjusted values common to all the input signals. If no adjusted values are stored in [LENS MEMORY], the values stored in [REF. LENS MEMORY] will be applied for lens adjustment.	→ page 125
LENS MEMORY	Adjusted values for each input signal. Use the adjusted values for the signal with a different aspect ratio or resolution. The adjusted values can be applied at the time of source selection.	→ page 116

NOTE:

- The lens shift, zoom, and focus adjustments can be performed with the remote control. (→ page 24, 25, 28)
- PX700W2/PX800X2: The NP06FL, NP07ZL, NP08ZL, NP09ZL and NP10ZL lenses do not support Zoom position and Focus position. Do not use the LENS MEMORY function to store the lens shift position data when using the NP06FL lens. Doing so may cause a shadow on the screen.
- PX750U2: Do not use the LENS MEMORY function to store the lens shift position data when using the NP16FL lens. Doing so may cause a shadow on the screen.
Zoom position data cannot be stored because the NP16FL lens does not have a zoom function.
- Be sure to perform [CALIBRATION] after replacement of the lens.

Usage Example

When you wish to display on a screen having a 4:3 aspect ratio an NTSC or other 4:3 aspect ratio signal and an SXGA or other 5:4 aspect ratio signal:

Perform shift, focus, and zoom adjustments to set the vertical screen size of the vertically tall 5:4 aspect ratio signal to standard.

Both 4:3 aspect ratio signals and 5:4 aspect ratio signals can now be displayed.

Note that with these shift, focus, and zoom adjustments, the 4:3 aspect ratio signal will become smaller on the screen. To eliminate this size reduction, adjust the shift, focus and zoom to the optimum condition for each of the 4:3 aspect ratio signal and the 5:4 aspect ratio signal.

Memory (storage) of each of these values will permit projection at an optimum condition upon signal switching.

To store your adjusted values in [REF. LENS MEMORY]:

1. Press the MENU button.



The menu will be displayed.

2. Press the ► button to select [SETUP] and press the ENTER button.

3. Press the ► button to select [INSTALLATION (1)].

4. Press the ▼ button to select [REF. LENS MEMORY] and press the ENTER button.

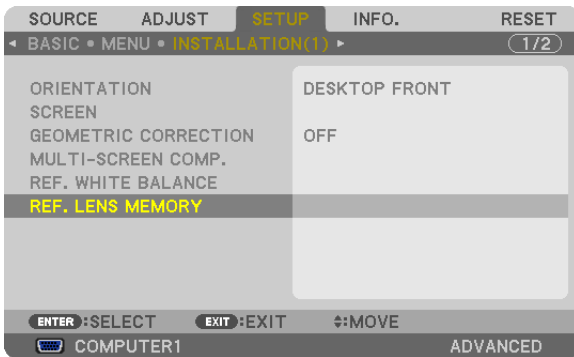

The [REF. LENS MEMORY] screen will be displayed.

5. Select [STORE] and press the ENTER button.



The confirmation screen will be displayed.

6. Press the ◀ button to select and [YES] and press the ENTER button.

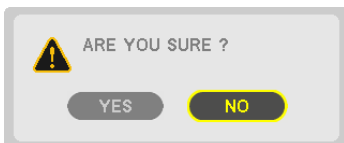

The adjusted values for lens shift, zoom, and focus have been stored in [REF. LENS MEMORY].

7. Press the MENU button.

The menu will be closed.

TIP:

- To store adjusted values for each input source, use the Lens Memory function.

To call up your adjusted values from [REF. LENS MEMORY]:

1. Press the **MENU** button.



The menu will be displayed.

2. Press the **▶** button to select [SETUP] and press the **ENTER** button.
3. Press the **▶** button to select [INSTALLATION (1)].
4. Press the **▼** button to select [REF. LENS MEMORY] and press the **ENTER** button.

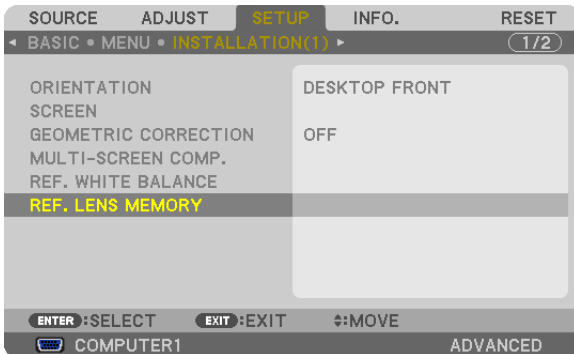

The [REF. LENS MEMORY] screen will be displayed.

5. Select [MOVE] and press the **ENTER** button.



The confirmation screen will be displayed.

6. Press the **◀** button to select and [YES] and press the **ENTER** button.

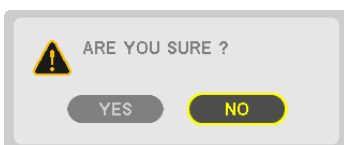

The adjusted values will be applied to the current signal. .

7. Press the **MENU** button.

The menu will be closed.

TIP:

To call up the adjusted values from [LENS MEMORY]:

1. From the menu, select [ADJUST] → [LENS MEMORY] → [MOVE] and press the ENTER button.



The confirmation screen will be displayed.

2. Press the ◀ button to select and [YES] and press the ENTER button.

The adjusted values stored in [LENS MEMORY] will be applied to the current signal.

To automatically apply the adjusted values at the time of source selection:

1. From the menu, select [SETUP] → [REF. LENS MEMORY] → [LOAD BY SIGNAL] and press the ENTER button.



2. Press the v button to select and [ON] and press the ENTER button.

This will move the lens automatically to the position at the time of source selection according to the adjusted values.

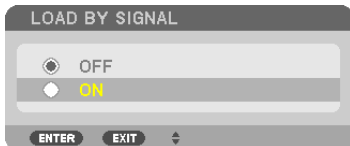

NOTE: The Lens Memory function may not produce a completely aligned image (due to tolerances in the lenses) using the adjusted values stored in the projector. After calling up and applying the adjusted values from the Lens Memory function, finely adjust the lens shift, zoom and focus to produce the best possible image.

① Displaying a Picture Using [EDGE BLENDING]

The EDGE BLENDING function allows a multi-screen image with high resolution to be displayed on a large screen. This function adjusts overlapping edges of images projected from each projector to uniform multi-screen images.

NOTE:

- For projector throw distances, refer to “Throw distance and screen size” on page 212, 213, 214, 215.
- Before performing the Edge Blending function, place the projector in the correct position so that the image becomes square in the appropriate size, and then make optical adjustments (lens shift, focus, and zoom).

Before explaining use of the Edge Blending function

This section explains the case for “Example: Placing two projectors side by side”. As shown, the projected image on the left is referred to as “Projector A” and the projected image on the right is referred to as “Projector B”. Unless otherwise specified hereinafter, the “projector” is used to mean both A and B.

Example: Placing two projectors side by side

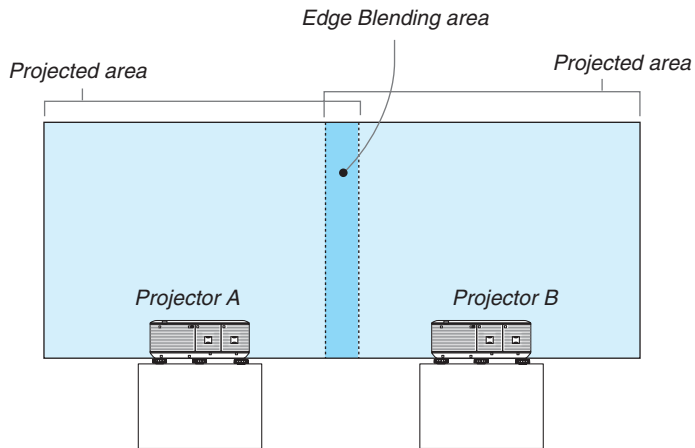

Preparation:

- Turn on the projector and display a signal.
- To use two or more projectors, you have to turn on [CONTROL ID] from the menu. For more information, refer to “Setting ID to the Projector [CONTROL ID]” on page 126.

① Enable [EDGE BLENDING].

1 Select [SETUP] → [EDGE BLENDING] and press the ENTER button.



2 Select [MODE] → [ON] and press the ENTER button.

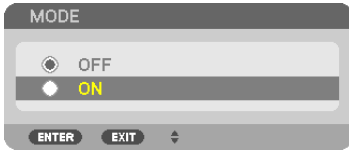

This enables the Edge Blending function. The following menu items are available: [TOP], [BOTTOM], [LEFT], [RIGHT], and [BLACK LEVEL]

3 Select [RIGHT] for Projector A and [LEFT] for Projector B.

Press the ENTER button.

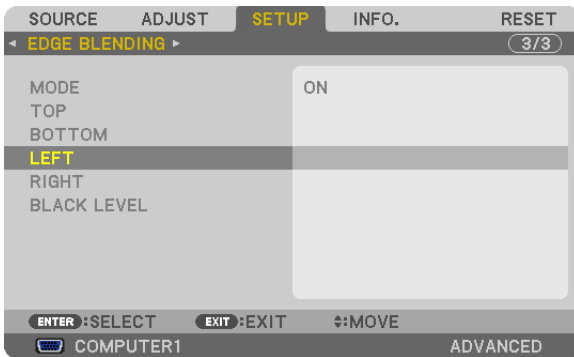

The following items are available: [CONTROL], [MARKER], [RANGE], and [POSITION]

4 Select [CONTROL] → [ON] and press the ENTER button.

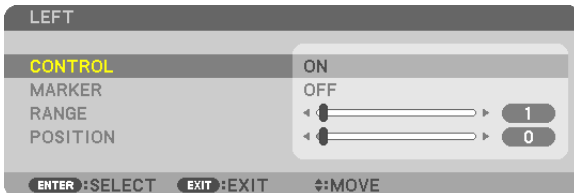

Each [TOP], [BOTTOM], [LEFT], [RIGHT], and [BLACK LEVEL] has its own [CONTROL], [MARKER], [RANGE], and [POSITION]. Turning on [CONTROL] will make [MARKER], [RANGE], and [POSITION] available.

② Adjust [RANGE] and [POSITION] to determine an area of overlapped edges of images projected from each projector.

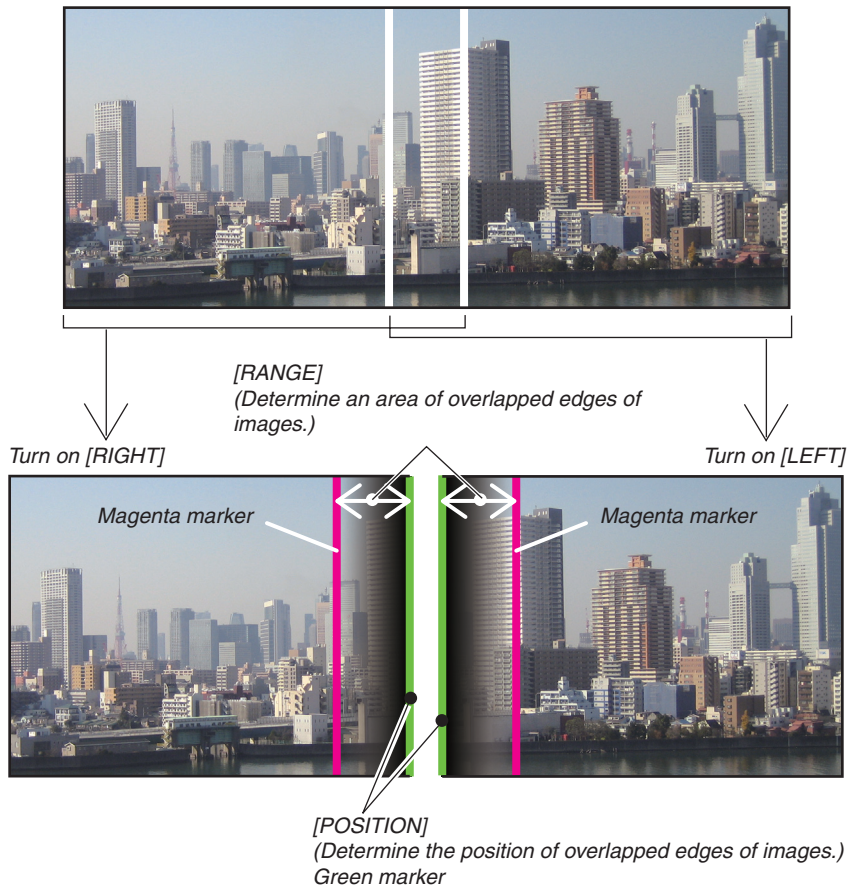

Turning on [MARKER] will display markers in magenta and green. The magenta marker is used for [RANGE] and green one for [POSITION].

1 Adjust [RANGE].

Use the ◀ or ▶ button to adjust the overlapped area.

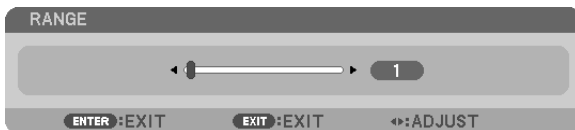

TIP:

- Adjust to overlap one projector' marker with the other projector's marker.

2 Adjust [POSITION].

Use the ◀ or ▶ button to align one edge with the other edge of overlapped images.



TIP:

- When displaying a signal with a different resolution, perform the Edge Blending function from the start.
- Setting of [MARKER] will not be saved and return to [OFF] when the projector is turned off.
- To display or hide the marker while the projector is running, turn on or off [MARKER] from the menu.
- If you want to make differences in white balance and brightness between projectors less visible, adjust [REF. WHITE BALANCE] and [MULTI-SCREEN COMP.] to obtain the possible best results. (→ page 124)

Black Level Adjustment

If you notice any differences in the brightness of an image, use [BLACK LEVEL] to adjust the darkest part or the level of brightness.

NOTE:

This function is enabled only when [MODE] is turned on.
Adjustable area varies depending on what combination of [TOP], [BOTTOM], [LEFT] and [RIGHT] are turned on.

Example: Adjusting the Black Level when placing two projectors side by side

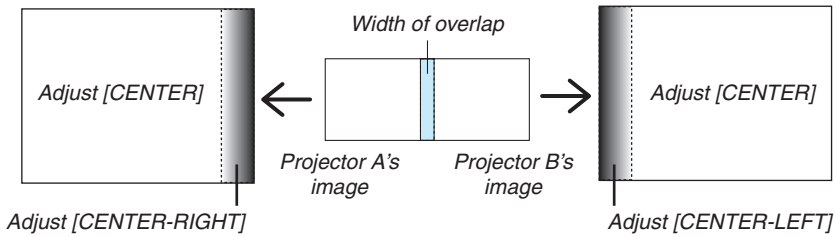

1. Turn on [MODE]
2. Select [BLACK LEVEL] and press the ENTER button.

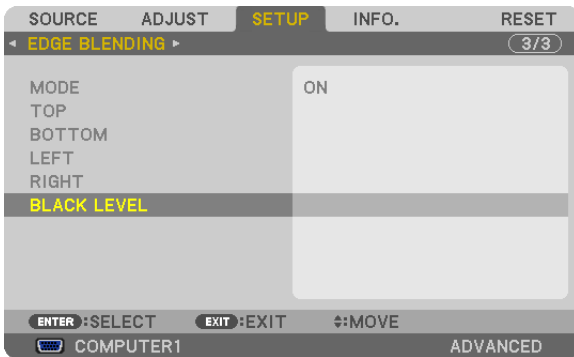

3. Use the ▼ or ▲ button to select an item and use the ◀ or ▶ to adjust the black level.
Do this for the other projector if necessary.

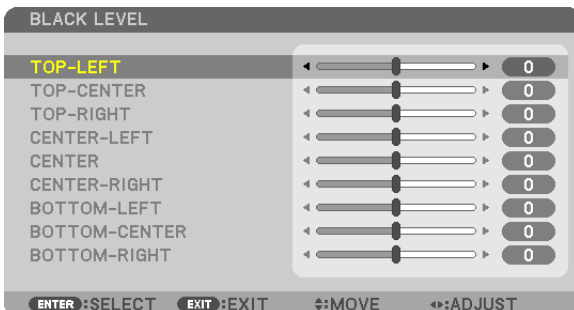

9-segmented portions for Black Level adjustment

The center projector

This function adjusts the brightness level of 9-segmented portions for the center projector and 4-segmented portions for the left bottom projector as shown below.

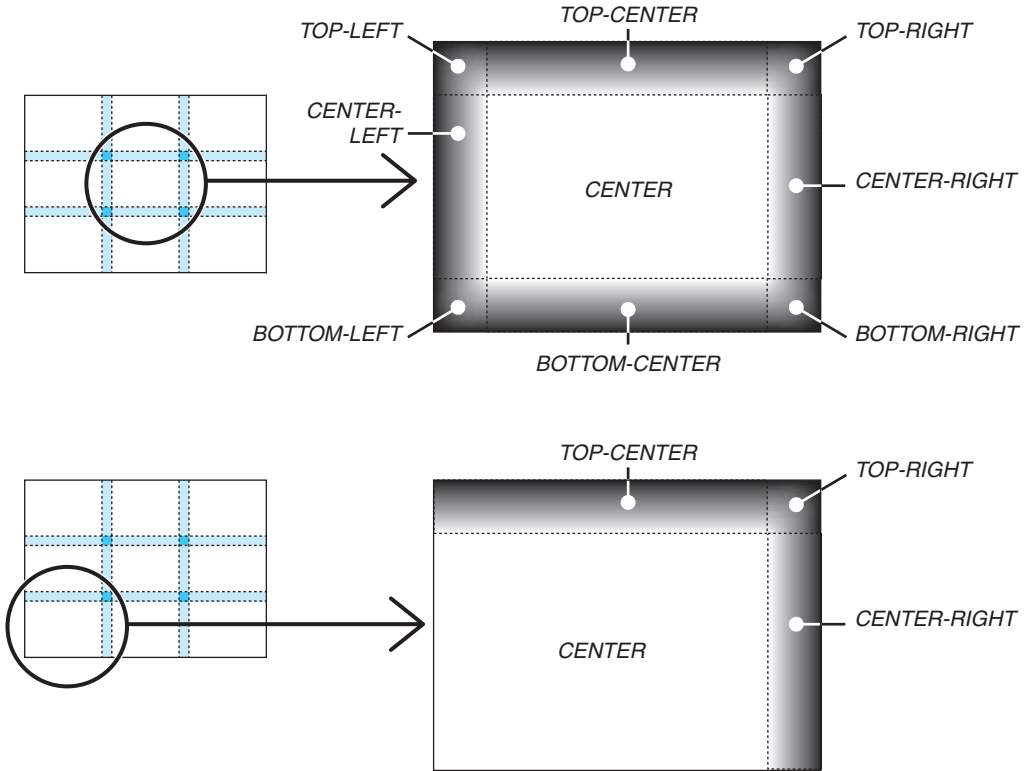

12 Controlling the Projector by Using an HTTP Browser

Overview

The HTTP Server function provides settings and operations for:

1. Setting for wired/wireless network (NETWORK SETTINGS)

To use wireless LAN connection, the optional USB Wireless LAN Unit is required. (→ page 172)

To use wired/wireless LAN connection, connect the projector to the computer with a commercially available LAN cable. (→ page 171)

2. Setting Alert Mail (ALERT MAIL)

When the projector is connected to a wired/wireless network, lamp replace time or error messages will be sent via e-mail.

3. Operating the projector

Power on/off, selecting input, and picture adjustments are possible.

4. Setting PJLink PASSWORD and AMX BEACON

Two ways of access to the HTTP server function are available:

- **Start the Web browser on the computer via the network connected to the projector and enter the following URL :**
`http://<the projector's IP address> /index.html`
- **Use Image Express Utility 2.0 contained on the supplied NEC Projector CD-ROM.**

TIP: The factory setting IP address is [DHCP ON].

NOTE:

- *To use the projector in a network, consult with your network administrator about network settings.*
 - *The display's or button's response can be slowed down or operation may not be accepted depending the settings of your network. Should this happen, consult your network administrator. The projector may not respond if its buttons are repeatedly pressed in rapid intervals. Should this happen, wait a moment and repeat. If you still can't get any response, turn off and back on the projector.*
 - *If the PROJECTOR NETWORK SETTINGS screen does not appear in the web browser, press the Ctrl+F5 keys to refresh your web browser (or clear the cache).*
 - *This device uses "JavaScript" and "Cookies" and the browser should be set to accept these functions. The setting method will vary depending on the version of browser. Please refer to the help files and the other information provided in your software.*
-

Preparation before Use

Connect the projector to a commercially available LAN cable before engaging in browser operations. (→ page 171)
Operation with a browser that uses a proxy server may not be possible depending on the type of proxy server and the setting method. Although the type of proxy server will be a factor, it is possible that items that have actually been set will not be displayed depending on the effectiveness of the cache, and the contents set from the browser may not be reflected in operation. It is recommended that a proxy server not be used unless it is unavoidable.

Handling of the Address for Operation via a Browser

Regarding the actual address that is entered for the address or entered to the URL column when operation of the projector is via a browser, the host name can be used as it is when the host name corresponding to the IP address of the projector has been registered to the domain name server by a network administrator, or the host name corresponding to the IP address of the projector has been set in the “HOSTS” file of the computer being used.

Example 1: When the host name of the projector has been set to “pj.nec.co.jp”, access is gained to the network setting by specifying
 http://pj.nec.co.jp/index.html
 for the address or the entry column of the URL.

Example 2: When the IP address of the projector is “192.168.73.1”, access is gained to the network setting by specifying
 http://192.168.73.1/index.html
 for the address or the entry column of the URL.

PROJECTOR ADJUSTMENT

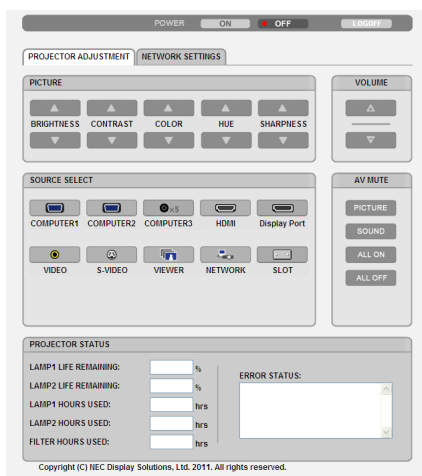

POWER: This controls the power of the projector.
 ON Power is switched on.
 OFF Power is switched off.

VOLUME: This control is not available on this model.

AV-MUTE: This controls the mute function of the projector.
 PICTURE Mutes the video.
 PICTURE Cancels the video muting.
 SOUND* Mutes the audio.
 SOUND* Cancels the audio muting.
 ALL ON Mutes each of the video, and audio* functions.
 ALL OFF Cancels the muting of each of the video, and audio* functions.

NOTE:

* The sound mute function is not available because the projector does not have an audio function.

PICTURE: Controls the video adjustment of the projector.

BRIGHTNESS ▲ Increases the brightness adjustment value.

BRIGHTNESS ▼ Decreases the brightness adjustment value.

CONTRAST ▲ Increases the contrast adjustment value.

CONTRAST ▼ Decreases the contrast adjustment value.

COLOR ▲ Increases the color adjustment value.

COLOR ▼ Decreases the color adjustment value.

HUE ▲ Increases the hue adjustment value.

HUE ▼ Decreases the hue adjustment value.

SHARPNESS ▲ Increases the sharpness adjustment value.

SHARPNESS ▼ Decreases the sharpness adjustment value.

- The functions that can be controlled will vary depending on the signal being input to the projector. (→ page 110)

SOURCE SELECT: This switches the input connector of the projector.

COMPUTER 1 Switches to the COMPUTER 1 IN connector.

COMPUTER 2 Switches to the COMPUTER 2 IN connector.

COMPUTER 3 Switches to the COMPUTER 3 IN connector.

HDMI Switches to the HDMI IN connector.

DisplayPort Switches to the DisplayPort.

VIDEO Switches to the VIDEO IN connector.

S-VIDEO Switches to the S-VIDEO IN connector.

VIEWER Switches to the data on the USB memory device.

NETWORK Switches to a LAN signal.

SLOT Switches to the optional board.

PROJECTOR STATUS: This displays the condition of the projector.

LAMP 1 LIFE REMAINING .. Displays the remaining life of the lamp 1 as a percentage.

LAMP 2 LIFE REMAINING .. Displays the remaining life of the lamp 2 as a percentage.

LAMP 1 HOURS USED Displays how many hours the lamp 1 has been used.

LAMP 2 HOURS USED Displays how many hours the lamp 2 has been used.

FILTER HOURS USED Displays how many hours the filter has been used.

ERROR STATUS Displays the status of errors occurring within the projector.

LOG OFF: Logging off your projector and returning to the authentication screen (LOGON screen).

NETWORK SETTINGS

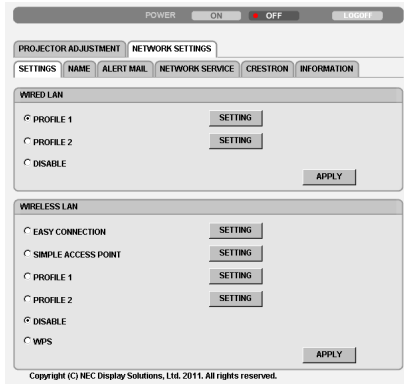

• **SETTINGS**

WIRED or WIRELESS

SETTING	Set for wired LAN or for wireless LAN.
APPLY	Apply your settings to wired LAN or wireless LAN.
DHCP ON	Automatically assign IP address, subnet mask, and gateway to the projector from your DHCP server.
DHCP OFF	Set IP address, subnet mask, and gateway to the projector assigned by your network administrator.
IP ADDRESS	Set your IP address of the network connected to the projector.
SUBNET MASK	Set your subnet mask number of the network connected to the projector.
GATEWAY	Set the default gateway of the network connected to the projector.
WINS	Set the IP address of your WINS server of the network connected to the projector when [DHCP] is turned on, this option is not available.
AUTO DNS ON	DHCP server will automatically assign IP address of DNS server connected to the projector.
AUTO DNS OFF	Set your IP address of DNS server connected to the projector.

Setting for WIRED LAN

PROFILE 1/PROFILE 2	Two settings can be set for wired LAN connection. Select PROFILE 1 or PROFILE 2.
DISABLE	Turn off wired LAN connection

Setting for WIRELESS LAN (the optional Wireless LAN Unit required for Europe, Australia, and Asian countries)

EASY CONNECTION	Execute a wireless LAN using EASY CONNECTION.
SIMPLE ACCES POINT	Set the projector for simple access point.
WPS	Use WPS (Wi-Fi Protected Setup™) to set up the wireless LAN for the projector. NOTE: Use the projector's menus to make WPS connections and change the WPS profile settings.
CHANNEL	Select a channel. Available channels vary depending on the country and region. When you select [INFRASTRUCTURE], make sure that the projector and your access point are on the same channel; when you select [AD HOC], make sure that the projector and your computer are on the same channel.
PROFILE 1/PROFILE 2	Two settings can be set for wireless LAN connection. Select PROFILE 1 or PROFILE 2.
SSID	Enter an identifier (SSID) for wireless LAN. Communication can be done only with equipment whose SSID matches SSID for your wireless LAN.

3. Convenient Features

SITE SURVEY	Displays a list of available SSIDs for wireless LAN on site. Select an SSID which you can access.													
NETWORK TYPE	<p>Select communication method when using wireless LAN.</p> <p>INFRASTRUCTURE: Select this option when communicating with one or more equipment connected to the wireless LAN network via a wireless access point.</p> <p>AD HOC: Select this option when using the wireless LAN to directly communicate with a computer in peer-to-peer mode.</p>													
SECURITY TYPE	<p>Turn on or off the encryption mode for secure transmission. When turn on the encryption mode, set WEP key or encrypted key.</p> <table border="1"> <tr> <td>DISABLE</td> <td colspan="2">Will not turn on the encryption feature. Your communications may be monitored by someone.</td> </tr> <tr> <td>WEP 64 bit</td> <td colspan="2">Uses 64-bit datalength for secure transmission.</td> </tr> <tr> <td>WEP 128 bit</td> <td colspan="2">Uses 128-bit datalength for secure transmission. This option will increase privacy and security when compared to use of 64-bit datalength encryption.</td> </tr> <tr> <td colspan="2"> WPA-PSK TKIP / WPA-PSK AES/ WPA2-PSK TKIP / WPA2-PSK AES/ WPA-EAP TKIP EAP-TLS/ WPA-EAP AES EAP-TLS/ WPA-EAP TKIP PEAP-MSCHAP v2/ WPA-EAP AES PEAP-MSCHAP v2/ WPA2-EAP TKIP EAP-TLS/ WPA2-EAP AES EAP-TLS/ WPA2-EAP TKIP PEAP-MSCHAP v2/ WPA2-EAP AES PEAP-MSCHAP v2 </td> <td>These options provide stronger security than WEP.</td> </tr> </table> <p><i>NOTE:</i></p> <ul style="list-style-type: none"> • The WEP settings must be the same as communication devices such as PC or access point in your wireless network. • When you use WEP, your image transmission speed will slow down. • Other encryption keys than WEP 64bit and WEP 128bit are not available when [AD HOC] is selected from [NETWORK TYPE]. • To install a digital certificate, use the projector's menu. (→ page 149) 		DISABLE	Will not turn on the encryption feature. Your communications may be monitored by someone.		WEP 64 bit	Uses 64-bit datalength for secure transmission.		WEP 128 bit	Uses 128-bit datalength for secure transmission. This option will increase privacy and security when compared to use of 64-bit datalength encryption.		WPA-PSK TKIP / WPA-PSK AES/ WPA2-PSK TKIP / WPA2-PSK AES/ WPA-EAP TKIP EAP-TLS/ WPA-EAP AES EAP-TLS/ WPA-EAP TKIP PEAP-MSCHAP v2/ WPA-EAP AES PEAP-MSCHAP v2/ WPA2-EAP TKIP EAP-TLS/ WPA2-EAP AES EAP-TLS/ WPA2-EAP TKIP PEAP-MSCHAP v2/ WPA2-EAP AES PEAP-MSCHAP v2		These options provide stronger security than WEP.
DISABLE	Will not turn on the encryption feature. Your communications may be monitored by someone.													
WEP 64 bit	Uses 64-bit datalength for secure transmission.													
WEP 128 bit	Uses 128-bit datalength for secure transmission. This option will increase privacy and security when compared to use of 64-bit datalength encryption.													
WPA-PSK TKIP / WPA-PSK AES/ WPA2-PSK TKIP / WPA2-PSK AES/ WPA-EAP TKIP EAP-TLS/ WPA-EAP AES EAP-TLS/ WPA-EAP TKIP PEAP-MSCHAP v2/ WPA-EAP AES PEAP-MSCHAP v2/ WPA2-EAP TKIP EAP-TLS/ WPA2-EAP AES EAP-TLS/ WPA2-EAP TKIP PEAP-MSCHAP v2/ WPA2-EAP AES PEAP-MSCHAP v2		These options provide stronger security than WEP.												
INDEX	Select encryption key when selecting [WEP 64 bit] or [WEP 128 bit] in [SECURITY TYPE].													
KEY	<p>When selecting [WEP 64 bit] or [WEP 128 bit] in [SECURITY TYPE]: Enter WEP key.</p> <table border="1"> <thead> <tr> <th>Select</th> <th>Characters (ASCII)</th> <th>Hexadecimal digit (HEX)</th> </tr> </thead> <tbody> <tr> <td>WEP 64 bit</td> <td>Up to 5 characters</td> <td>Up to 10 characters</td> </tr> <tr> <td>WEP 128 bit</td> <td>Up to 13 characters</td> <td>Up to 26 characters</td> </tr> </tbody> </table> <p>When selecting [WPA PSK-TKIP], [WPA PSK-AES], [WPA2 PSK-TKIP] or [WPA2 PSK-AES]: Enter encryption key. Key length must be 8 or greater and 63 or less.</p>		Select	Characters (ASCII)	Hexadecimal digit (HEX)	WEP 64 bit	Up to 5 characters	Up to 10 characters	WEP 128 bit	Up to 13 characters	Up to 26 characters			
Select	Characters (ASCII)	Hexadecimal digit (HEX)												
WEP 64 bit	Up to 5 characters	Up to 10 characters												
WEP 128 bit	Up to 13 characters	Up to 26 characters												
USERNAME	Set a user name for WPA-EAP/WPA2-EAP.													
PASSWORD	Set a password for WPA-EAP TKIP PEAP-MSCHAP v2/WPA-EAP AES PEAP-MSCHAP v2/WPA2-EAP TKIP PEAP-MSCHAP v2/WPA2-EAP AES PEAP-MSCHAP v2.													
USE DIGITAL CERTIFICATE	Select this if you use a digital certificate for WPA-EAP TKIP PEAP-MSCHAP v2/WPA-EAP AES PEAP-MSCHAP v2/WPA2-EAP TKIP PEAP-MSCHAP v2/WPA2-EAP AES PEAP-MSCHAP v2.													

• NAME

PROJECTOR NAME	Enter a name for your projector so that your computer can identify the projector. A projector name must be 16 characters or less. TIP: Projector name will not be affected even when [RESET] is done from the menu.
HOST NAME	Enter the hostname of the network connected to the projector. A host name must be 15 or less.
DOMAIN NAME	Enter the domain name of the network connected to the projector. A domain name must be 60 characters or less.

• ALERT MAIL

ALERT MAIL	This option will notify your computer of lamp replace time or error messages via e-mail when using wireless or wired LAN. Placing a checkmark will turn on the Alert Mail feature. Clearing a checkmark will turn off the Alert Mail feature. Sample of a message to be sent from the projector: The lamp and filters are at the end of its usable life. Please replace the lamp and filters. Projector Name: XXXXX Lamp 1 Hours Used: XXX [H] Lamp 2 Hours Used: XXX [H]
SENDER'S ADDRESS	Enter sender's address.
SMTP SERVER NAME	Enter the SMTP server name to be connected to the projector.
RECIPIENT'S ADDRESS 1, 2, 3	Enter your recipient's address. Up to three addresses can be entered.
TEST MAIL	Send a test mail to check whether your settings are correct or not <hr/> <i>NOTE:</i> • If you execute a test, you may not receive an Alert mail. Should this happen, check if network settings are correct. • If you entered an incorrect address in a test, you may not receive an Alert mail. Should this happen, check if the Recipient's Address is correct. <hr/>
SAVE	Click this button to save your settings to the projector's memory.

• NETWORK SERVICE

PJLink PASSWORD	Set a password for PJLink*. A password must be 32 characters or less. Do not forget your password. However, if you forget your password, consult with your dealer.
HTTP PASSWORD	Set a password for HTTP server. A password must be 10 characters or less.
AMX BEACON	Turn on or off for detection from AMX Device Discovery when connecting to the network supported by AMX's NetLinx control system. <i>TIP:</i> <i>When using a device that supports AMX Device Discovery, all AMX NetLinx control system will recognize the device and download the appropriate Device Discovery Module from an AMX server. Placing a checkmark will enable detecting the projector from AMX Device Discovery. Clearing a checkmark will disable detecting the projector from AMX Device Discovery.</i>

NOTE: If you forget your password, contact your dealer.

*What is PJLink?

PJLink is a standardization of protocol used for controlling projectors of different manufacturers. This standard protocol is established by Japan Business Machine and Information System Industries Association (JBMI) in 2005. The projector supports all the commands of PJLink Class 1.

Setting of PJLink will not be affected even when [RESET] is done from the menu.

CRESTRON ROOMVIEW compatibility

The projector supports CRESTRON ROOMVIEW, allowing multiple devices connected in the network to be managed and controlled from a computer or a controller.

For more information, visit <http://www.crestron.com>

<Setting Procedure>

Access to the HTTP server function, and make necessary settings for [CRESTRON] in [NETWORK SETTINGS].

• ROOMVIEW for managing from the computer.

DISABLE	Disables ROOMVIEW.
ENABLE	Enables ROOMVIEW.

• CRESTRON CONTROL for managing from the controller.

DISABLE	Disables CRESTRON CONTROL.
ENABLE	Enables CRESTRON CONTROL.
IP ADDRESS	Set your IP address of CRESTRON SERVER.
IP ID	Set your IP ID of CRESTRON SERVER.

• INFORMATION

WIRED LAN	Display a list of settings of wired LAN connection.
WIRELESS LAN	Display a list of settings of wireless LAN connection.
UPDATE	Reflect settings when they are changed.

TIP: The CRESTRON settings are required only for use with CRESTRON ROOMVIEW.

For more information, visit <http://www.crestron.com>

13 Projecting Your Computer's Screen Image from the Projector via a Network [NETWORK PROJECTOR]

By selecting the projector connected to the same network as that of your PC, the PC screen image can be projected to the screen via network. There is no need of connection using the computer cable (VGA).

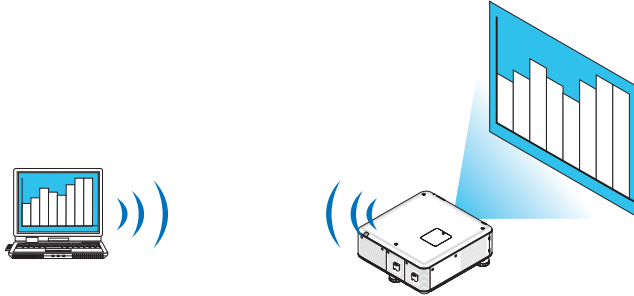

Operation Environment

Applicable OS	Windows 7 Professional Windows 7 Ultimate Windows 7 Enterprise Windows Vista Home Premium Windows Vista Business Windows Vista Ultimate Windows Vista Enterprise
Hardware specifications	The specifications recommended by Microsoft as the operation environment for Windows 7/Windows Vista should be satisfied.
Network Environment	Wired LAN or wireless LAN environment that supports TCP/IP is required.
Screen color	High Color (16 bits) True Color (24 bits and 32 bits) * Setting with 256 colors or less is not available.

Setting the Projector to Network Projector Input Mode

1. **With the projector turned on, press the SOURCE button.**

The input selection window appears.

Another way to display the input selection window is to press the NETWORK button on the remote control. The APPLICATION MENU screen will be displayed. Go to step 3.

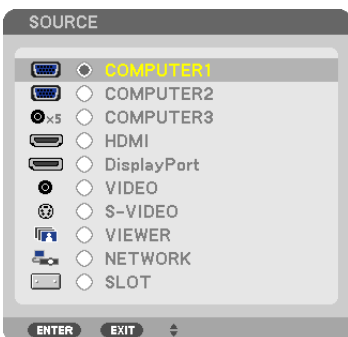

Projecting the Image with Network Projector

1. Click **[Start]** from the desktop of Windows 7.
2. Click **[All Programs]**.
3. Click **[Accessories]**.
4. Click **[Connect to a Network Projector]**.

When the **[Permission Connect to a Network Projector]** window appears, click **[Yes.]**.

The “Connect to a Network Projector” window appears.

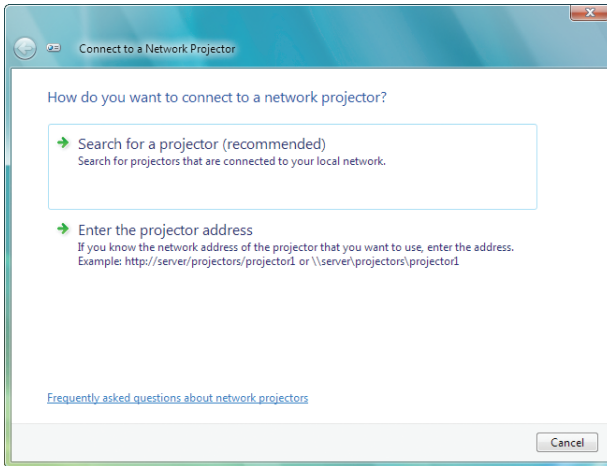

5. Click **[→ Search for a projector (recommended)]**.

In the “Available projectors” box, “PX750U Series” is displayed.

6. Click **[PX750U Series]**.

The message “Enter the password for the projector that you selected.” is displayed at the bottom of the window.

7. Input the password to the password input box displayed by the operation at step 3 on page 64.

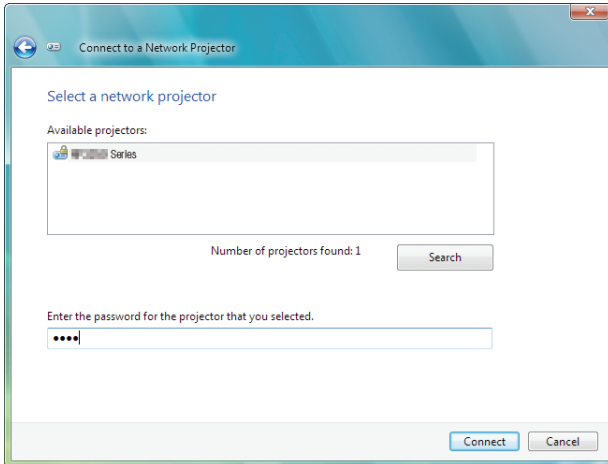

8. Click [Connect].

The network projector function works and the screen of Windows 7 is projected from the projector.

- If the resolution of your computer's screen is different from the projector's screen resolution, the NETWORK PROJECTOR function may not work. If this happens, change the resolution of the computer's screen to lower resolution than the one displayed at Step 3 on page 64.

NOTE: When the network projector function works, the background color of the desktop changes to solid color. When the network projector function is stopped, the original background color is restored.

Reference: If the projector cannot be found at Step 5, click [→ Enter the projector address]. Then, input the "Network address" (Input example: `http://10.32.97.61/lan`) and "Projectorpassword" (Input example: 82291627) displayed in the screen projected from the projector.

Exiting the Network Projector Operation

1. Click [Projecting: PX750U Series] in the Windows Vista task bar.

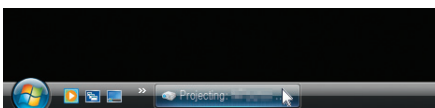

2. Click [Disconnect].

The Network Projector function is stopped.

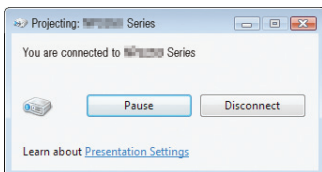

3. Press the SOURCE button of the projector to select an input terminal other than [NETWORK].

When using the remote control, press a button other than the NETWORK button.

14 Using the Projector to Operate Your Computer via a Network [REMOTE DESKTOP]

- By selecting the PC connected to the same network as that of the projector, the PC screen image can be projected to the screen via network.
Then, by operating the keyboard, you can operate Windows 7, Windows Vista or Windows XP on the PC connected with the network.
- With the Remote Desktop function, you can remotely operate the PC placed at a distance from the projector.

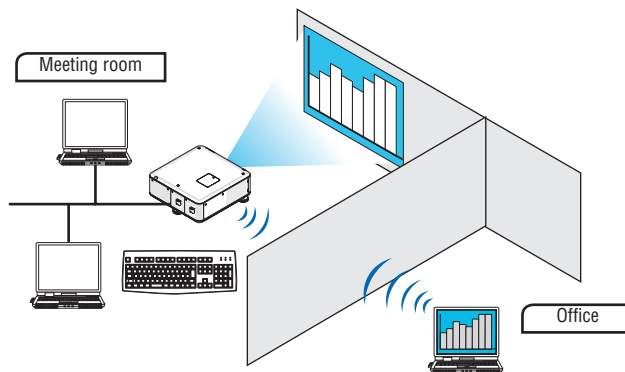

NOTE:

- The [REMOTE DESKTOP] function will work on the following Windows editions.
Windows 7 Professional
Windows 7 Ultimate
Windows 7 Enterprise
Windows Vista Business
Windows Vista Ultimate
Windows Vista Enterprise
Windows XP Professional with Service Pack 3
(Note)
- In this user's manual this feature is described using Windows 7 as an example, but Windows Vista and Windows XP Professional Service Pack 2 or later will also work with this feature.
- A keyboard is required to use the Remote Desktop function.
- The Remote Desktop function can be operated with a keyboard. Using a wireless mouse with a wireless keyboard is more useful for operating.
Use a commercially available wireless keyboard, a wireless mouse, and a USB wireless receiver.
Use a commercially available USB keyboard and USB mouse.
- A USB keyboard with a built-in USB hub cannot be used with the projector.
- A wireless keyboard or mouse that supports Bluetooth cannot be used with the projector.
- We do not warrant that the USB port of the projector will support all USB devices in the market.

3. Convenient Features

Prepare a commercially available wireless keyboard (US layout version).

Connect the USB wireless receiver to the USB port (Type A) of the projector. Make all necessary settings for your wireless keyboard and mouse.

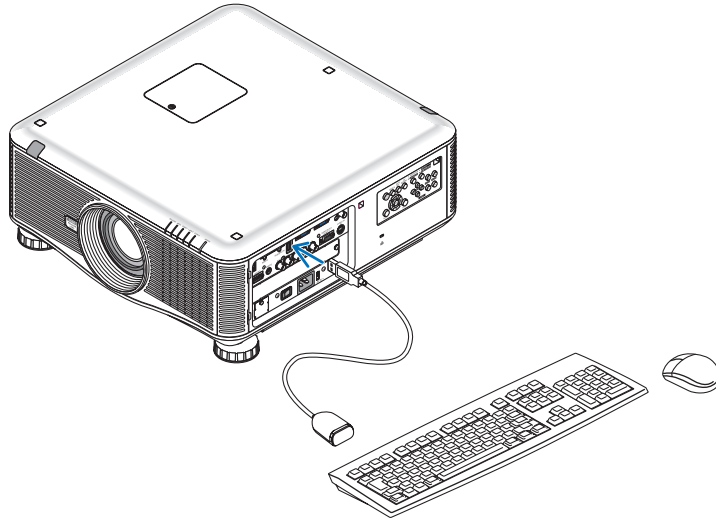

Setting the password to the user account of Windows 7

TIP: If a password has been set for an account, the steps 1 to 9 can be skipped.

1. Click [Start] from the desktop of Windows 7.
2. Click [Control Panel].
3. Click [Add or remove user accounts] displayed under [User Accounts].
4. When the [User Account Control] confirmation window appears, click [Continue].
5. Click [Administrator].
6. Click [Create a password].
7. Input the password to the [New password] box.
8. Input the same password as that at Step 7 to the [Confirm new password] box.
9. Click [Create a password].

The Administrator is changed to [Password Protection].

Setting the Remote Access

1. Click [Start] from the desktop of Windows 7.
2. Click [Control Panel].
3. Click [System and Security].
4. Click [Allow remote access] displayed under [System].
5. When the [User Account Control] confirmation window appears, click [Continue].
The [System Properties] window appears.
6. Click [Allow connections from computers running any version of Remote Desktop (less secure)] in the Remote Desktop box and click [OK].

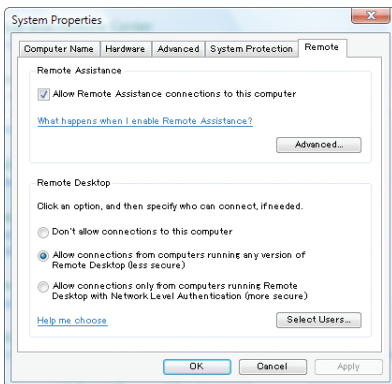

Checking the IP address on Windows 7

1. Click [Start] from the desktop of Windows 7.
2. Click [Control Panel].
3. Click [View network status and tasks] displayed under [Network and Internet].

4. Click [View status] displayed in blue on the right of [Local Area Connection] in the window.

The [Local Area Connection Status] window appears.

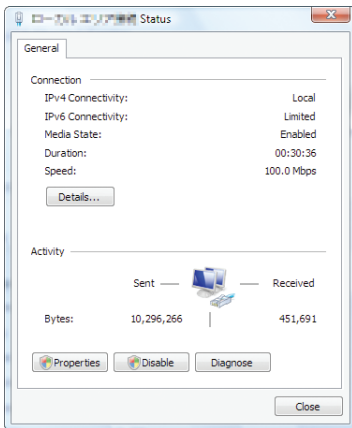

5. Click [Details...].

Write down the value for "IPv4 IP Address" (xxx.xxx.xxx.xxx) displayed.

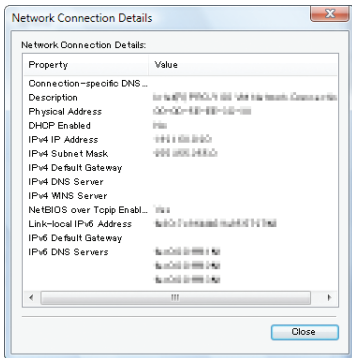

6. Click [Close].

7. Click [X] at the upper right of the window.

The system goes back to the desktop.

Starting the Remote Desktop

1. With the projector turned on, press the SOURCE button.

The input selection window appears.

Another way to display the input selection window is to press the NETWORK button on the remote control. The APPLICATION MENU screen will be displayed. Go to step 3.

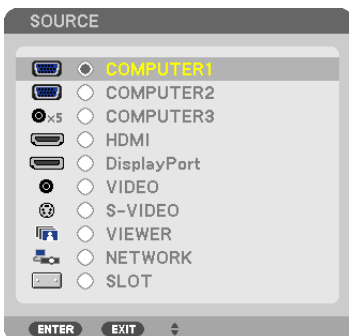

3. Convenient Features

2. Press the ▼ or ▲ button to select [NETWORK] and press the ENTER button.

The [APPLICATION MENU] menu will be displayed.

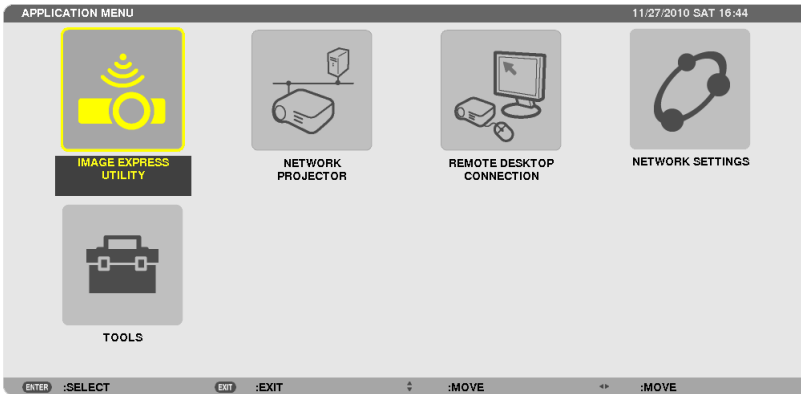

3. From the [APPLICATION MENU] menu, use the wireless keyboard to select [REMOTE DESKTOP CONNECTION].

The [REMOTE DESKTOP CONNECTION] window appears.

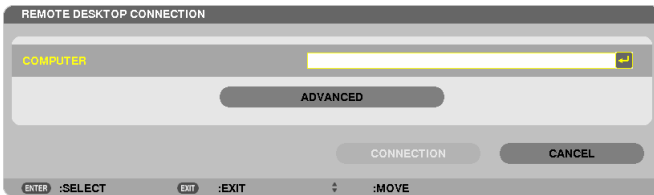

4. Operate the wireless keyboard to input the IP address of Windows 7 and click “Connect”.

The log-on screen of Windows 7 is displayed in the screen projected by the projector.

5. Operate the wireless keyboard to input the user’s password and press “Enter”.

The remote desktop function is started.

Windows 7 desktop is displayed in the screen projected by the projector.

Log out the computer.

Use the wireless keyboard connected to the projector to operate Windows 7.

NOTE: When the projection is made with the remote desktop function, the background color of the desktop is changed to solid color.

Exiting the Remote Desktop

1. Operate the wireless keyboard to click [Start] from the desktop screen projected by the projector.

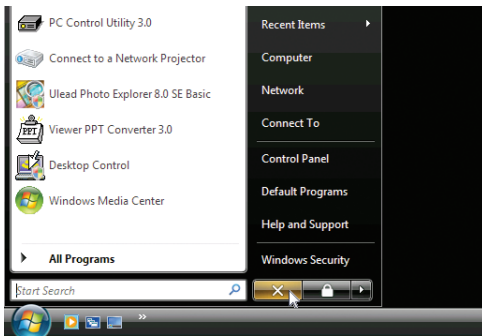

2. Click [X] on the right of the start menu.

The remote desktop function is stopped.

3. Press the **SOURCE** button of the projector to select an input terminal other than [NETWORK].

When using the remote control, press a button other than the NETWORK button.

TIP:

Setting [OPTIONS] in REMOTE DESKTOP

Clicking [OPTIONS] displays the [PERFORMANCE] screen.

Making settings to [OPTIONS] will allow you to display the desktop background, or to enable the window animation function during the Remote Desktop operation. However, doing this will cause the display's or mouse's response to slow down.

If the display's or mouse's response is slowed down, try one or more of the following:

DESKTOP BACKGROUND: Clear the check mark to display the desktop background in solid color.

MENU AND WINDOW ANIMATION: Clear the check mark to disable menu and window animation.

THEMES: Clear the check mark not to use Themes.

SHOW CONTENTS OF WINDOW WHILE DRAGGING: Clear the check mark to show only the window pane while dragging.

4. Using the Viewer

① What you can do with the Viewer

The Viewer feature allows you to view slides or movie files stored on a USB memory on the projector, or a shared folder in a computer connected to the network.

The Viewer has the following features.

- When a commercially available USB memory that stores image files is inserted into the USB port (Type A) of the projector, the Viewer allows you to view the image files on the USB memory.
Even if no computer is available, presentations can be conducted simply with the projector.
- Movie file can be played back.
- A Microsoft PowerPoint file or Adobe PDF file can be simply projected on the screen without connecting a computer.
- Image and movie files stored in a shared folder in a computer connected to a network can be projected.
The computer with “Media Sharing” of Windows Media Player 11 turned on can be used as a media server.

Supported graphic formats

Format	File name extension
JPEG	.jpg, .jpe, .jpeg (CMYK is not supported.)
BMP	.bmp (bit field not supported)
PNG	.png (Interlaced PNG and α channel PNG are not supported.)
GIF	.gif (Interlaced GIF, transparation GIF, and animation GIF are not supported.)

* If an unsupported image is selected, the icon  will be displayed.

NOTE:

Maximum number of pixels of image which can be displayed are:

- Baseline JPEG: 10000 × 10000
- Progressive JPEG: 1280 × 1280
- GIF: 1280 × 1280
- Others: 4000 × 4000
- Some files supported by the above requirements may not be displayed.

Supported movie files

File name extension	Video compression/expansion method	Audio compression/expansion method
.mpg, .mpeg.	MPEG2	MPEG Audio Layer2
		MPEG Audio Layer3
.wmv	VC-1/WMV9	WMA9 Standard
.mp4	H.264/AVC	AAC-LC

Playback requirements:

Resolution: 320 × 240 to 1280 × 720

Video frame rate: up to 30fps

Bitrate: up to 15Mbps

Max. file size: up to 2GB

NOTE:

- Some files supported by the above requirements may not be played back.
When a supported movie file is played back, its audio will not be output from the projector.

NOTE:

- *Movie files converted by using the video/audio format which is not supported by this projector cannot be played back. In this case, there will be no icon to show that playback is not possible.*
- *Files with Digital Rights Management(DRM) protection cannot be played back.*
- *Some of the movie files that meet the above requirements may not be played back.*
- *WMV format video file will be displayed in an aspect ratio of 1 to 1 independently of its original aspect ratio.*
- *Files that can be played back on the media server are graphics and movie files. In Windows Media Player 11 (Windows XP/Windows Vista) mp4 files cannot be played back.*

Supported PDF files

File name extension	Supported file format
.pdf	Adobe Acrobat PDF

NOTE:

- *Fonts not embedded in PDF file may not be displayed*
- *Functions added to PDF file after created will not work or display. Functions added are bookmarks, boxes in form tool, and notes will not be displayed.*
Auto flip or Auto transition will not work.
- *Some PDF files may not be displayed.*

Supported PowerPoint files

File name extension	Supported file format
.ppt, .pptx	Microsoft PowerPoint 97 – 2007

NOTE:

- *Playable fonts, colors, font ornament, placement, object insertion or animation are restricted.*
- *Some Microsoft PowerPoint 97 – 2007 files may not be displayed.*

Supported USB memory devices

- Be sure to use a USB memory device formatted with the FAT, exFAT, FAT32 or FAT16 file system.
The projector does not support NTFS formatted USB memory.
If the projector does not recognize your USB memory, check if the format is supported.
To format your USB memory in your computer, refer to the document or help file that comes with your Windows.
- We do not warrant that the USB port of the projector will support all USB memories in the market.
- Wait at least 5 seconds after disconnecting a USB memory device before reconnecting it and vice versa.
The projector may not identify the USB memory device if it is repeatedly connected and disconnected in rapid intervals.

Notices on shared folder and media server

- Files from a shared folder or media server may not be projected if security or antivirus software is installed on your computer.
- Open the following firewall ports:

- Media server

Port number	Protocol
1900	UDP
2869	TCP
10243	TCP
10280-10284	UDP

- Shared folder

Port number	Protocol
137	UDP/TCP
138	UDP/TCP
139	UDP/TCP
445	UDP/TCP

- Set your computer for sharing and security to grant access to files in the shared folder and set your security or antivirus software to grant access to files in the shared folder. Consult your network administrator for more information.
- Movie files in the shared folder or the media server may not be played back correctly depending on your network environment or the bit rate of your file.

NOTE:

Do not disconnect between the projector and your computer by removing the LAN cable or turning off the projector when a PowerPoint file or PDF file is displayed from a shared folder. Doing so will make Viewer inoperable.

NOTE:

- The following operations by using the buttons on the projector are not possible when the VIEWER screen such as the slide screen and the thumbnail screen is displayed.
 - Auto Adjustment by using the AUTO ADJ. button
 - Freezing picture by using the CTL + PIP/FREEZE or AUTO ADJ. button on the remote control is not possible when the VIEWER screen such as the slide screen and the thumbnail screen is displayed.
 - Executing [RESET] → [ALL DATA] from the menu will return the settings for the Viewer toolbar to the factory default.
-

2 Preparing presentation materials

1. Create your presentation materials and save them in a supported file format to your computer.

- See page 98 for supported file formats.
- Make sure that PowerPoint file is displayed on the Viewer before giving your real presentation.
With Viewer PPT Converter 3.0, you can convert your PowerPoint files to index files that can be displayed on the Viewer. Viewer PPT Converter 3.0 can be downloaded from our website.
- When creating a PDF file, embed your fonts in your PDF file. Embedding fonts requires Adobe Acrobat. This cannot be done in Adobe Reader.

TIP:

• Using Print Command

Example for font embedding using Print Command. See the help of Adobe Acrobat for more information.

1. Select “Print” from the “File” menu.
2. Select “Adobe PDF” from “Printer name” and click the “Properties” button.
3. Click the “Edit” button in the “Adobe PDF Settings” tab.
4. Click the font tab in the Edit window to select the font embed window.

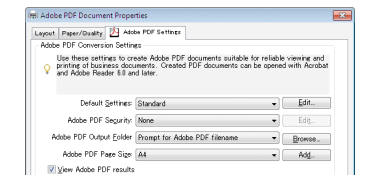
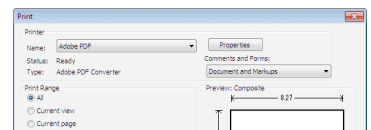

5. Place a check mark for “Embed all fonts”.

Click “OK” to return to the Print window, and click “OK” to start creating a PDF file.

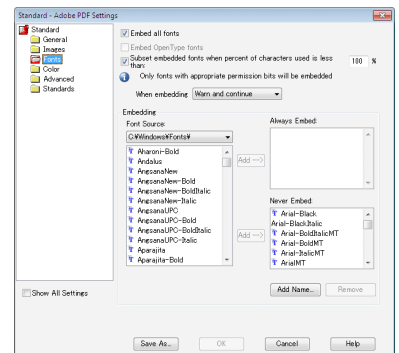

2. Save a file to your drive.

To save a file to your USB memory:

Use the Windows Explore to copy the file to your USB memory.

To place a file in a shared folder you create in your computer, see page 89.

To use “Media Sharing” in Windows Media Player 11, see page 93.

3 Projecting images stored in a USB memory device

This section explains the basic operation of the Viewer.

The explanation provides the operational procedure when the Viewer toolbar is set to the factory default.

Preparation: Before starting the Viewer, store images to the USB memory using your computer.

Starting the Viewer

1. Turn on the projector. (→ page 17)
2. Insert the USB memory into the USB port of the projector.

NOTE:

- Do not remove the USB memory from the projector while its LED flashes. Doing so may corrupt the data.

TIP:

You can a USB memory insert the projector when the drive list screen is displayed.

3. Press the **SOURCE** button to select [VIEWER].

A press of the **SOURCE** button will display the source select screen.

A few more presses of the **SOURCE** button will display the drive list screen.

Another way to select [VIEWER] is to press the **VIEWER** button on the remote control.

TIP:

- For more information about the drive list screen, see page 81.
- To display graphics in a shared folder, see page 89; to display still images or movie files in a media server, see page 93.

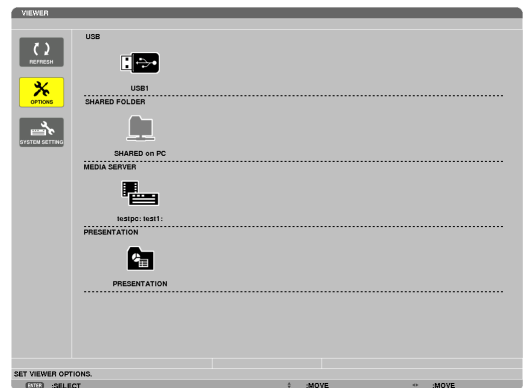
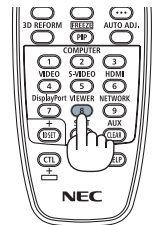
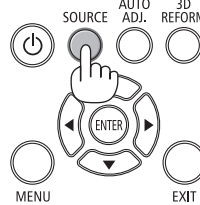
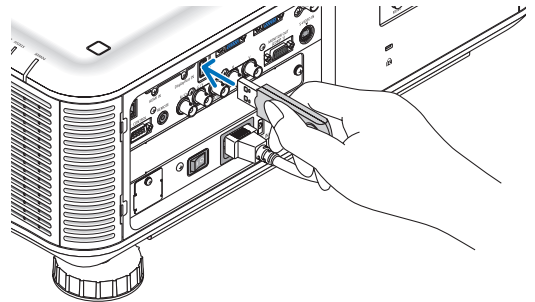

4. Using the Viewer

4. Press the **▶** button to select “USB1” and press the **ENTER** button.

The “USB1” thumbnail screen will be displayed.

TIP:

- For more information about thumbnail screen, see page 83.

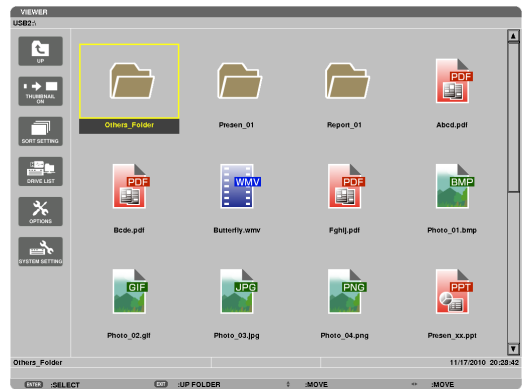

5. Use the **▲▼◀▶** or **▶** button to select an icon.

- The **→** (arrow) symbol on the right indicates there are more pages.

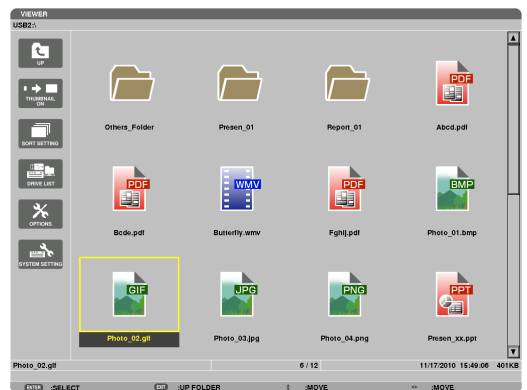

6. Press the **ENTER** button.

Operation varies depending on the selected file.

• Still image

The selected slide will be displayed.

The **◀** or **▶** button can be used to select the next (right) slide or the previous (left) slide in the thumbnail screen.

- Pressing the **ENTER** button will display the control bar with which is used to select or rotate an slide.(→ page 84)

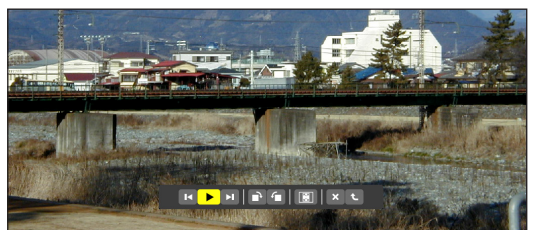

• **Movie file**

The movie file will start playing.

After finishing the playback, the screen will turn to black. Press the EXIT button to return to the thumbnail screen.

- Pressing the ENTER button will display the movie's control bar with which you can pause or fastforward and some other operations.

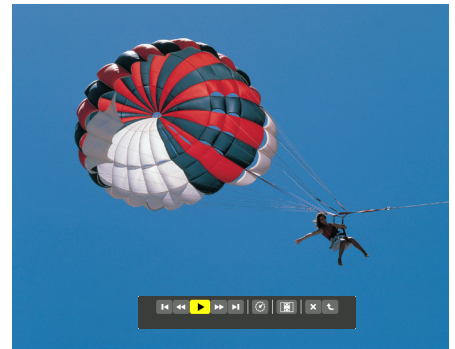

• **Microsoft PowerPoint file**

The slide on the first page will be displayed.

Press ► to select the next slide; press ◀ to select the previous slide.

- You can also use the ▼ or ▲ button to select a page. To return to the thumbnail screen, press the EXIT button.

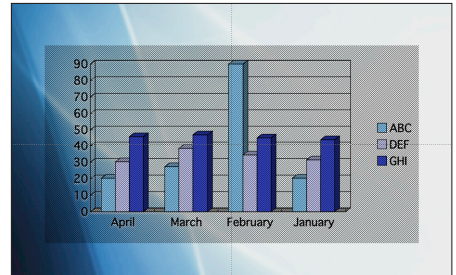

NOTE:

- Files with slideshow or animation effects may not be correctly displayed on the Viewer.

See "Supported PowerPoint files" on page 74, 98.

• **Adobe PDF file**

The first page will be displayed.

- The PDF file will fill the width of the screen.

Pressing the ▼ or ▲ button will scroll the screen down or up.

To return to the thumbnail screen, press the EXIT button.

- When a password input window is displayed, it means that the PDF file is password-protected.

Pressing the ENTER button will show the software keyboard. Use the software keyboard to enter your password. Select [OK] and press the ENTER button. The PDF file will be displayed.

- For more information on the software keyboard, see page 152.

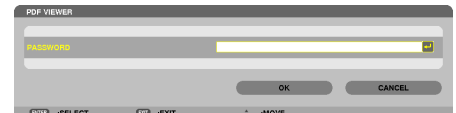
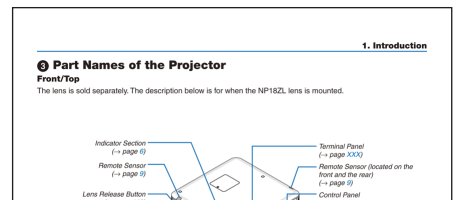

NOTE:

Bookmarks and notes that were added after PDF conversion will not be displayed.

If fonts were not embedded at the time of PDF conversion, those fonts will not be displayed.

TIP:

It takes some time (about 30 seconds to two minutes) to display a large size file or to turn pages of a PDF file that has many pages.

- **Index file (extension:.idx)**
- Index files, which is converted by using Viewer PPT Converter 3.0, will appear in the Thumbnail screen. Only folders and JPEG files converted by using Viewer PPT Converter 3.0 will appear in the Thumbnail screen.
- To select slideshow of index files, open the [PRESENTATION] folder in the DRIVE LIST screen. However, index files will not appear. Only folders and JPEG files will appear.
- Up to four index folders in your USB and shared folder are displayed. The four folders will be displayed in reverse chronological order
- When you insert the USB memory device storing index with the Viewer in operation, the content of the index files will be displayed.



NOTE:

- The play mode (MANUAL/AUTO) for slides of index file works in the following way:
In case of [MANUAL] for [PLAY MODE]
When you select [OPTIONS] → [SLIDE SETTING] → [PLAY MODE] → [MANUAL], index files will be set for manual playback in regardless of whether [INTERVAL] is set.
In case of [AUTO] selected for [PLAY MODE]
When you select [OPTIONS] → [SLIDE SETTING] → [PLAY MODE] → [AUTO], index files will be set for auto playback at intervals specified by using [INTERVAL].
When, however, [-1] is selected for [INTERVAL], the play mode will be set for auto playback according to the setting for [OPTIONS] → [SLIDE SETTING] → [INTERVAL].

7. Remove the USB memory from the projector.

Return to the drive list screen. Make sure that the LED on the USB memory is not flashing before removing the USB memory.

NOTE: If you remove the USB memory from the projector with a slide displayed, the projector may not operate correctly. If this happens, turn off the projector, turn off the main power switch, and unplug the power cord. Wait 3 minutes, then connect the power cord, turn on the main power switch, and turn on the projector.

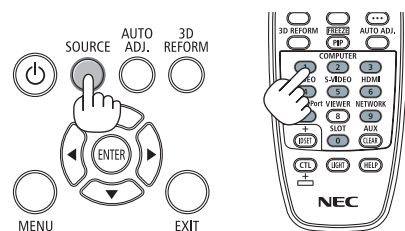
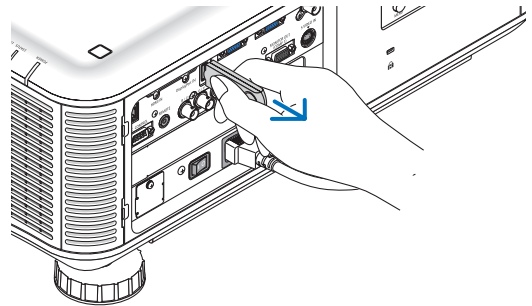

Exiting the Viewer

1. Press the SOURCE button to select a source other than [VIEWER].

A press of the SOURCE button will display the source select screen.

A few more presses of the SOURCE button will display another source.

- To exit the Viewer using the remote control, select a source other than [VIEWER].

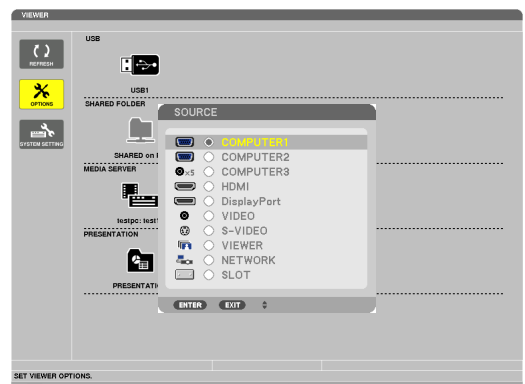

Names and functions of Viewer screen

The Viewer has three screens: Drive list screen, Thumbnail screen, and Slide screen.

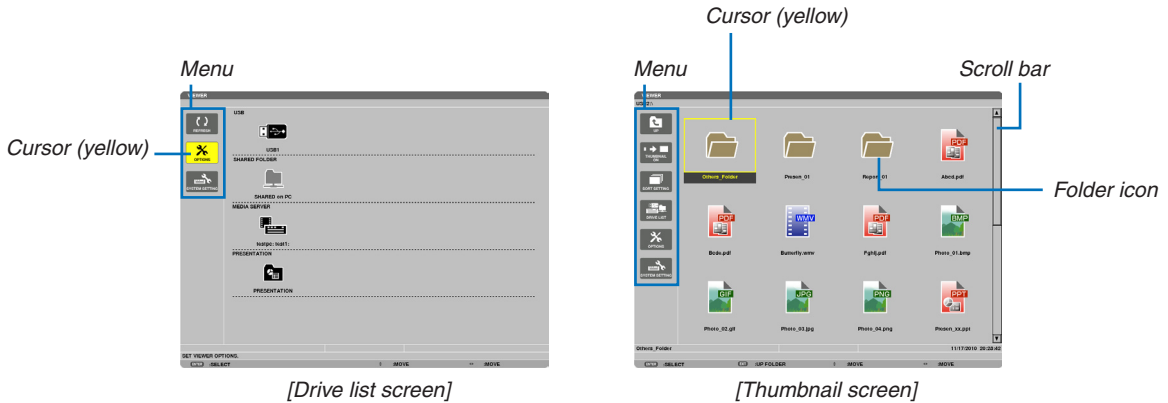

Path information



Drive information/File information



Menu guide

Operation button guide

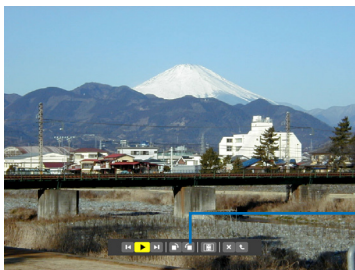

[Slide screen]

Control bar

* The operation for still image differs from that for movie.

• Drive list screen

Displays a list of drives connected to the projector.

Menu operation

- Use the ▼ or ▲ button to move the cursor up or down. Select the menu item and press the ENTER button to display the submenu.

Operation for Drive list screen













1. Press the ► button to move the cursor to the drive list.

(Use the ◀ or ▶ button to switch between the menu and the drive list.)

Press the ▼ or ▲ button to select a type of drive; press the ◀ or ▶ button to select the drive connected to the projector.

2. Select the drive and press the ENTER button to switch to the thumbnail screen of the selected drive.

Functions

Name	Description
 REFRESH	Displays additional media servers in the drive list screen.
 OPTIONS	Opens the OPTIONS menu.
 SLIDE SETTING	Sets up slides. (→ page 86)
 MOVIE SETTING	Sets up movie files. (→ page 87)
 AUTO PLAY SETTING	Sets up auto play. (→ page 87)
 SHARED FOLDER	Sets up a shared folder. (→ page 89)
 MEDIA SERVER	Sets up a media server. (→ page 93)
 RETURN	Closes the OPTIONS menu.
 SYSTEM SETTING	Switches to the system setting menu. See wired LAN, wireless LAN, WPS, network information, mouse, and keyboard in “9. Application Menu”. (→ page 139)
 USB	Displays the icon for a USB memory inserted into the USB port of the projector.
 SHARED FOLDER	Displays up to four drives of a computer connected to a LAN (set for connecting a shared folder). * See page 89 for setting up for connecting a shared folder of the projector.
 MEDIA SERVER	Displays up to four drives of a computer connected to a LAN (set for connecting a media server). * See page 93 for setting up for connecting a media server of the projector
 PRESENTATION	Displays the icon when a USB memory or shared folder stores index files.
Path information	Displays the location of a folder or file.
Drive information	[Example] <div style="display: flex; justify-content: space-around; align-items: center;"> <div style="text-align: center;"> <u>USB1</u> Displays the drive. </div> <div style="text-align: center;"> <u>314MB FREE/492MB</u> Displays free space and capacity of a drive. (USB only) </div> </div>
Menu guide	Displays the description of a selected menu.
Operation button guide	Displays information about operation buttons.

* It is displayed in three-digit number (rounding up)

NOTE:

When the OPTIONS menu is displayed, the drive list screen or thumbnail screen is not displayed. To display it, select the [RETURN] icon and press the ENTER button.

• Thumbnail screen

Displays a list of folders, thumbnails, and icons in the drive selected on the drive list screen.







Menu operation

- Use the ▼ or ▲ button to move the cursor up or down. Select the menu item and press the ENTER button to display the menu or setting screen.

Operation for Thumbnail screen

1. Press the ► button to move the cursor to the thumbnail screen when the OPTIONS menu is not displayed.
2. Press the ▼, ▲, ◀, or ▶ button to select a file or folder.
3. Press the ENTER button to start slideshow or playback of the selected file. Selecting a folder will display its thumbnail screen.

Functions

Name	Description
 UP	Goes to one upper level menu.
 THUMBNAIL	Switches two displays between thumbnail and icon.
 SORT SETTING	Rearranges folders or files.
 DRIVE LIST	Returns to the drive list screen.
 OPTIONS	Changes to the OPTIONS menu.
 SYSTEM SETTING	Opens the system setting menu.
Scroll bar	Thumbnail screen will display 12 files with 4 by 3. If the thumbnail screen has twelve or more files or folders, the scroll bar will be displayed at the right side.
Path information	Displays the location of a folder or file.
Thumbnail information	<p>[Example]</p> <p style="text-align: center;"> <u>005.jpg</u> <u>5/200</u> <u>11/03/2010 13:25:12</u> <u>502KB</u> </p> <p style="text-align: center;"> Selected folder name or file name Numbers and order of files in a folder (only when folder selected) Create/Change date: M/D/Y/H/M/B Displays file capacity </p>
Menu guide	Displays the description of a selected menu.
Operation button guide	Displays information about operation buttons.

TIP:

- If an unsupported image is selected, the icon [?] will be displayed,
- The maximum displayable number of images is 300 in the thumbnail screen including the number of folders.
- If a file name or path of a folder is longer than specified, it will be displayed with center characters or path skipped.
Example: "123456789.jpg" will be displayed in "123..789.jpg".

• Slide screen (still image/movie)

Plays a file selected from a list of thumbnails or icons.

- For operating a Microsoft PowerPoint file and Adobe PDF file, see page 79.

Control bar operation

- The control bar will be displayed only when a still image (or index file) and a movie file is selected.
- The control bar for still images differs from that for movie files.









1. Pressing the ENTER button in Slide screen will display the control bar at the bottom of the screen.

2. Use the ◀ or ▶ button to select a file and press the ENTER button.

- The selected function will be executed.











Functions of still image control bar



Name	Description	
 PREV	Goes back to the previous image. The ▲ button will do the same function.	
 PLAY	Plays the image. This button also is used to stop or start playing an image.	
 NEXT	Goes to the next image. The ▼ button will do the same function.	
 RIGHT	Rotates the image 90° clockwise. • To cancel, select another folder.	
 LEFT	Rotates the image 90° counter clockwise. • To cancel, select another folder.	
SIZE	 BEST FIT	Displays the image with its aspect ratio in the projector's displayable maximum resolution.
	 ACTUAL SIZE	Displays the image in its actual size.
 CLOSE	Closes the control bar. • You can also press the EXIT button to close the control bar.	
 END	Stops playing slides or slideshow, and closes the control bar to return to the thumbnail screen.	

Functions of movie control bar



Name	Description	
 PREV	Goes back to the beginning of a movie file. <ul style="list-style-type: none"> • Goes back to the beginning of the previous movie file if executed immediately after being started playing. 	
 FR	Fast-rewinds a movie file for about 7 seconds.	
PLAY/PAUSE	 PLAY	Plays a movie file.
	 PAUSE	Stops playing a movie file.
 FF	Fast-forwards a movie file for about 7 seconds.	
 NEXT	Goes to the beginning of a next movie file.	
 TIME	Displays an elapsed time for playback or pause.	
SIZE	 BEST FIT	Displays the image with its aspect ratio in the projector's displayable maximum resolution.
	 ACTUAL SIZE	Displays the image in its actual size.
 CLOSE	Closes the control bar. <ul style="list-style-type: none"> • You can also press the EXIT button to close the control bar. 	
 END	Stops playing a movie, and closes the control bar to return to the thumbnail screen.	

Viewer option settings

• SLIDE SETTING

Sets still images or slides.

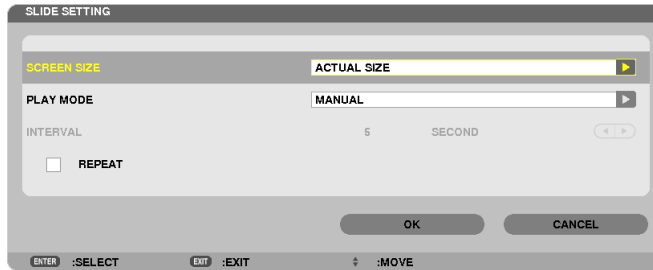

Name	Options	Description
SCREEN SIZE	BEST FIT	Displays the image with its aspect ratio in the projector's displayable maximum resolution.
	ACTUAL SIZE	Displays the image in its actual size.
PLAY MODE	MANUAL	Selects manual play.
	AUTO	Selects auto play.
INTERVAL	5 - 300 seconds	Specifies interval time when [AUTO] is selected for PLAY MODE.
REPEAT	Check mark	Turns on or off the repeat function.

TIP

- To play one or more slides, place those files into a folder.

• **MOVIE SETTING**

Sets the functions for a movie file.

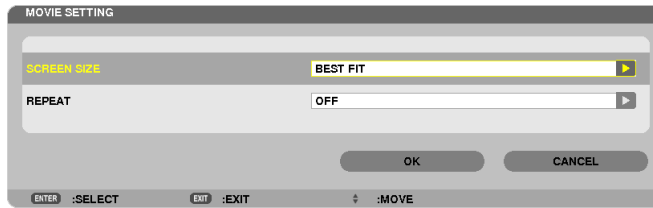

Name	Options	Description
SCREEN SIZE	BEST FIT	Displays the image with its aspect ratio in the projector's displayable maximum resolution.
	ACTUAL SIZE	Displays the image in its actual size.
REPEAT	OFF	Turns on or off the repeat function.
	ONE REPEAT	Repeats one file only.
	ALL REPEAT	Repeats all files in the current folder.

TIP

- Turning on [REPEAT] will display black screen during intermission between movies.

• **AUTO PLAY SETTING**

Sets auto play for slideshow when a USB memory device is inserted into the USB port of the projector, or when [VIEWER] is selected for [SOURCE].

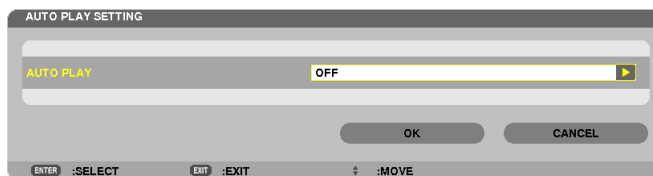

Name	Options	Description
AUTO PLAY	OFF	—
	PICTURE	Plays the first still image found in a drive.
	MOVIE	Plays the first movie found in a drive.
	PowerPoint	Plays the first PowerPoint file found in a drive.

TIP

- Auto play behavior is different between when a USB memory device is inserted into the USB port of the projector and when [VIEWER] is selected for [SOURCE].
- Auto play starts for the first found file supporting the file type set up for Auto Play. The file will be searched in the drive root or lower level.
- When [VIEWER] is selected for [SOURCE], the last selected file will be automatically played if it is found, or the last selected folder will be searched and the first found file will be automatically played.
To automatically play a movie file in a USB memory, store one movie file or change its file name so that it can be searched first.

- **SORT SETTING**

Sets the order of displaying thumbnails or slides.

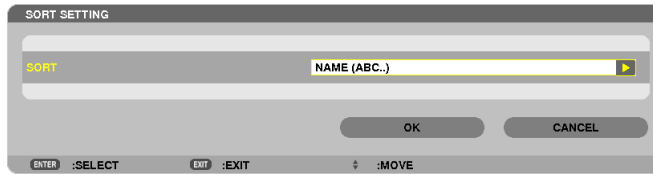

Name	Options	Description
SORT	NAME (ABC..)	Displays the files alphabetically by name in ascending order.
	NAME (ZYX..)	Displays the files alphabetically by name in descending order.
	EXT. (ABC..)	Displays the files alphabetically by extension in ascending order.
	EXT. (ZYX..)	Displays the files alphabetically by extension in descending order.
	DATE (NEW)	Displays the files in reverse chronological order.
	DATE (OLD)	Displays the files in chronological order.
	SIZE (BIG)	Displays the files in descending order of its file size.
	SIZE (SMALL)	Displays the files in ascending order of its file size.

④ Projecting data from shared folder

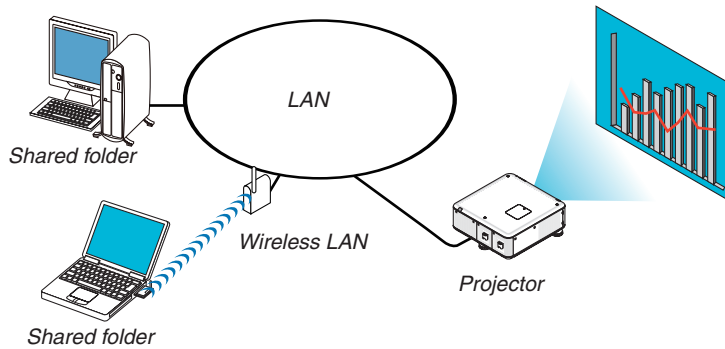

Preparation

For projector: Connect the projector to the network.

For computer: Place files to be projected in a shared folder and note the folder's path. Memorize or write down the path for later use.

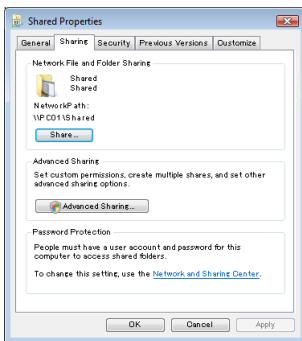

- For sharing a folder, refer to your user guide or help file accompanied with your Windows computer.
- Use a keyboard to give a name to the shared folder in alphanumeric characters.
- To connect the shared folder beyond the subnet, set [WINS CONFIGURATION] in [NETWORK SETTINGS] from the menu.
- Digital signature (SMB signature) is not supported.

Connecting the projector to the shared folder

1. Press the VIEWER button on the remote control.

The drive list window will be displayed.

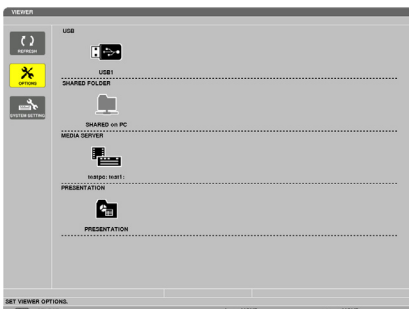

- Another way to start the VIEWER is to press the SOURCE button a few times on the projector cabinet. (→ page 21)

2. Displays the [OPTIONS] menu.

Press the ▼ button to select the  (OPTIONS) icon and press the ENTER button.

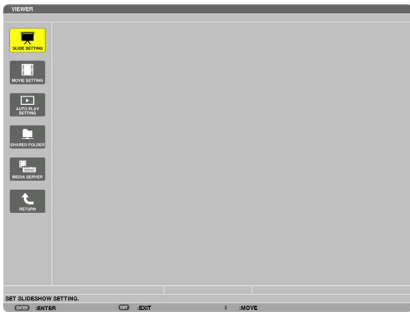

- When the OPTIONS menu is displayed, the drive list will not be displayed.

3. Display the [SHARED FOLDER SETTING] screen.

Press the ▼ button to select the  (SHARED FOLDER SETTING) icon and press the ENTER button.

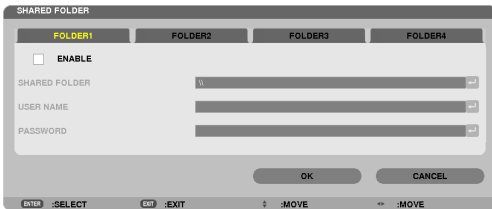

4. Select a folder number and place to enable it.

Press the ◀ or ▶ button to a shared folder number and press the ▼ button to select [ENABLE], and then press the ENTER button.

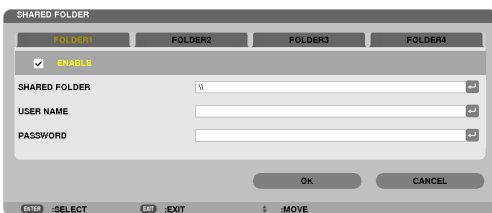

5. Enter the path, user name, and password for the shared folder.

Press the ▼ button to select the [SHARED FOLDER] field. The software keyboard will be displayed.

For using the software keyboard, see page 152.

- If your computer is not password protected, entering a password is not required.
- Up to four shared folders can be added.
- The maximum length of a path of the shared folder must be 15 alphanumeric characters for computer name and 23 alphanumeric characters for folder name.

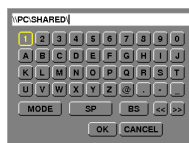
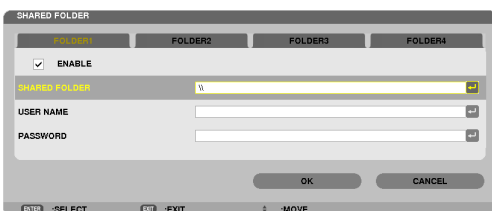

6. Exit the setting.

Press the ▼ button to select [OK] and press the ENTER button.

This will close the [SHARED FOLDER] screen.

- If an error message appear, your settings are not correct. Try again.

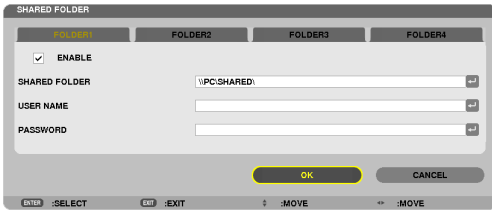

The screenshot shows a configuration window titled "SHARED FOLDER". At the top, there are four tabs: "FOLDER1", "FOLDER2", "FOLDER3", and "FOLDER4". The "FOLDER1" tab is selected. Below the tabs, there is a checkbox labeled "ENABLE" which is checked. Underneath, there are three input fields: "SHARED FOLDER" with the text "VPC:SHARED1", "USER NAME", and "PASSWORD". Each of these three fields has a small downward arrow on its right side. At the bottom of the window, there are two buttons: "OK" and "CANCEL". Below the window, there is a row of keyboard shortcuts: "ENTER :SELECT", "ESC :EXIT", "← :MOVE", and "→ :MOVE".

Disconnecting the shared folder from the projector

- **Disable the number of a shared folder you wish to disconnect**

Press the ▼ button to select [ENABLE] and press the ENTER button to clear it.

NOTE:

- When a PowerPoint file or PDF file is displayed, do not disconnect your LAN cable. If doing so, the Viewer will not work.

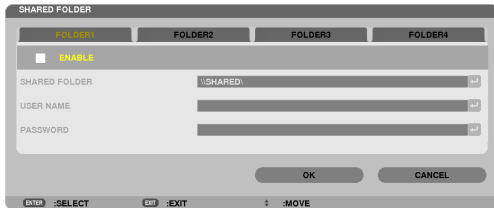

TIP:

- **Connecting settings for Shared folder**
Settings of up to four folders can be saved.
Restarting the projector will display setting-saved shared folders in grey folder icon on the drive list screen.
Selecting the grey icon folder will skip entry for a folder path.
- Failing to connect with a shared folder will display the folder icon with "x" mark. If this happen, check your folder setting.

5 Projecting data from media server

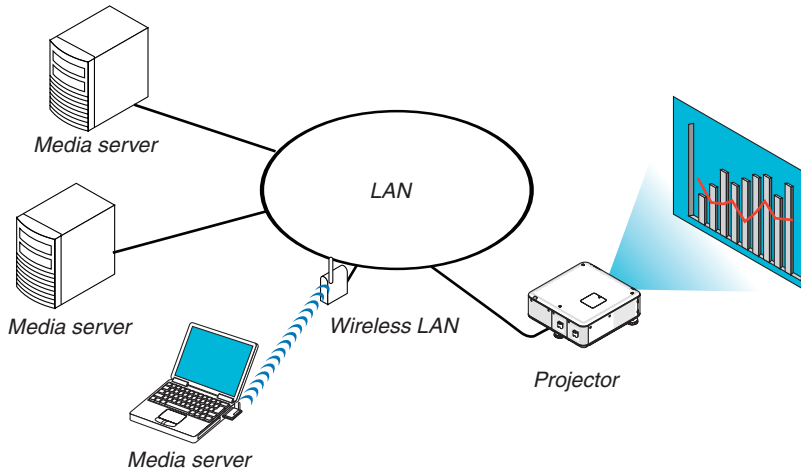

Preparation

For projector: Connect the projector to the network.

For computer: Prepare image files or movie files to be projected, and set up “Media Sharing” in Windows Media Player 11 or Windows Media Player 12.

NOTE:

- Both the projector and the media server must be on the same subnet. Connecting to the media server beyond the subnet is not possible.
- Types of images and movies which can be shared may vary depending on Windows version.

Setting up “Media Sharing” in Windows Media Player 11

1. Start Windows Media Player 11.
2. Select “Media Sharing” from “Library”.

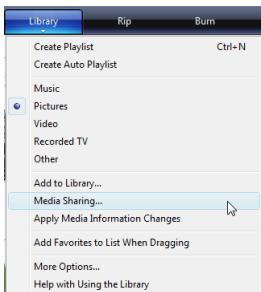

The “Media Sharing” dialog box will be displayed.

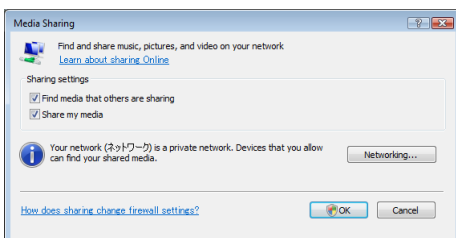

3. Select “Share my media” check box, and then select OK.

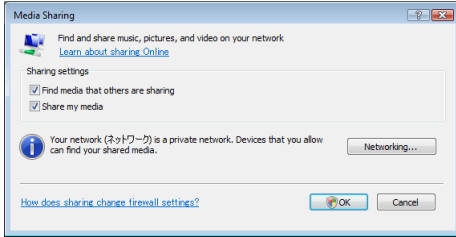

A list of accessible devices will be displayed.

4. Select “PX750U Series” and then “Allow”.

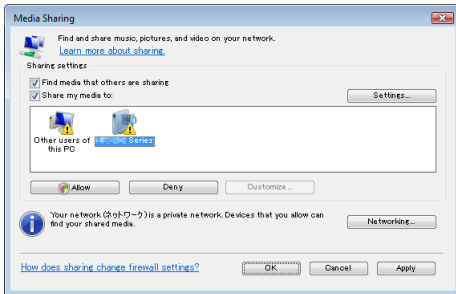

A check mark will be added to the “PX750U Series” icon.

- The “PX750U Series” is a projector name specified in [NETWORK SETTINGS].

5. Select “OK”.

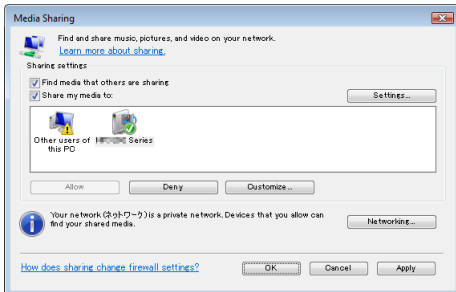

This will make pictures and video in “Library” available from the projector.

Setting up “Media Sharing” in Windows Media Player 12

1. Start Windows Media Player 12.

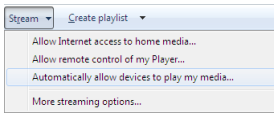

2. Select “Stream”, and then select “Automatically allow devices to play my media”.

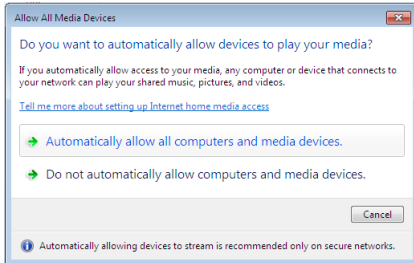

The “Allow All Media Devices” windows will be displayed.

3. Select “Automatically allow all computers and media devices”.

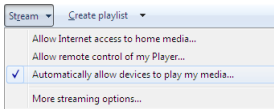

Graphics and movie files in “Library” can be used from the projector.

Connecting the projector to the media server

Press the VIEWER button on the remote control.
The VIEWER will start.

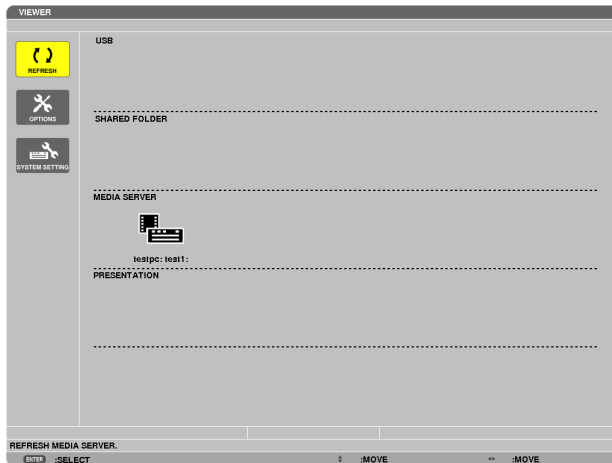

- Another way to start the VIEWER is to press the SOURCE button a few times on the projector cabinet. (→ page 21)
- This will start searching for a computer with “media sharing” enabled in the network and add it to the “Media server” of the thumbnail screen.

Another way to do this is to point the cursor to “Media server” and select [REFRESH] from the thumbnail menu and press the ENTER button.

NOTE:

- *Up to four accessible media servers can be automatically searched and displayed. The fifth device or later cannot be displayed.*
-

(→ page 77)

Disconnecting the projector from the media server

1. Display the **OPTIONS** menu.

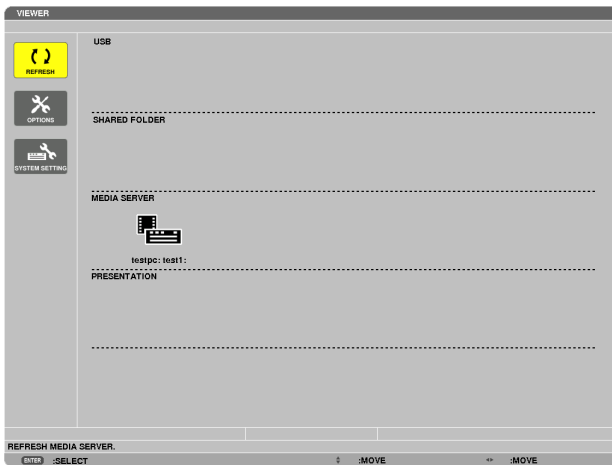

Press the ▼ button to select the [OPTIONS] icon and select the ENTER button.

2. Display the **MEDIA SERVER** setting screen.



Press the ▼ button to select the MEDIA SERVER icon and press the ENTER button.

3. Disable the connection.

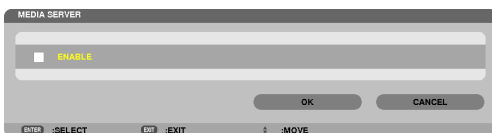

Press the ENTER button to clear the checkmark to disable the connection.

Press the ▼ button to select [OK] and press the ENTER button to close the MEDIA SERVER setting screen.

6 Restrictions on displaying files

The Viewer allows you to give a simplified display of a PowerPoint file or PDF file.

Due to simplified display, however, actual display may be different from the one on your computer application program.

Some restrictions on PowerPoint files

- Fonts will be automatically converted to the fonts installed in the projector. Fonts can vary in size or width, causing layout corruption
Some characters or fonts may not be displayed.
- Some functions included in font are not supported.
Example: There are some restrictions on animation, selection, or hyperlink.
- It may take longer time to feed pages compared with a computer
- In some cases Microsoft PowerPoint 97-2007 format files may not be displayed.

Some restrictions on PDF files

- Fonts not embedded at the time of PDF creation may not be displayed.
- Some functions included in font are not supported.
Example: There are some restrictions on annotations, selection, form, or color space.
- It may take longer time to feed pages compared with a computer
- In some cases Adobe Acrobat format files may not be displayed.

5. Using On-Screen Menu

① Using the Menus

NOTE: The on-screen menu may not be displayed correctly while interlaced motion video image is projected.

1. Press the **MENU** button on the remote control or the projector cabinet to display the menu.

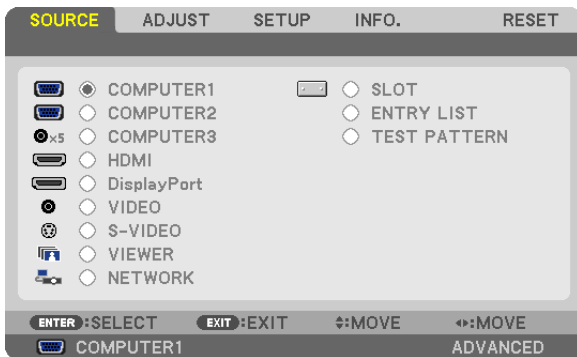

NOTE: The commands such as ENTER, EXIT, ▲▼, ◀▶ in the bottom show available buttons for your operation.

2. Press the **◀▶** buttons on the remote control or the projector cabinet to display the submenu.
3. Press the **ENTER** button on the remote control or the projector cabinet to highlight the top item or the first tab.
4. Use the **▲▼** buttons on the remote control or the projector cabinet to select the item you want to adjust or set.
You can use the **◀▶** buttons on the remote control or the projector cabinet to select the tab you want.
5. Press the **ENTER** button on the remote control or the projector cabinet to display the submenu window.
6. Adjust the level or turn the selected item on or off by using the **▲▼◀▶** buttons on the remote control or the projector cabinet.
Changes are stored until adjusted again.
7. Repeat steps 2-6 to adjust an additional item, or press the **EXIT** button on the remote control or the projector cabinet to quit the menu display.

NOTE: When a menu or message is displayed, several lines of information may be lost, depending on the signal or settings.

8. Press the **MENU** button to close the menu.
To return to the previous menu, press the **EXIT** button.

2 Menu Elements

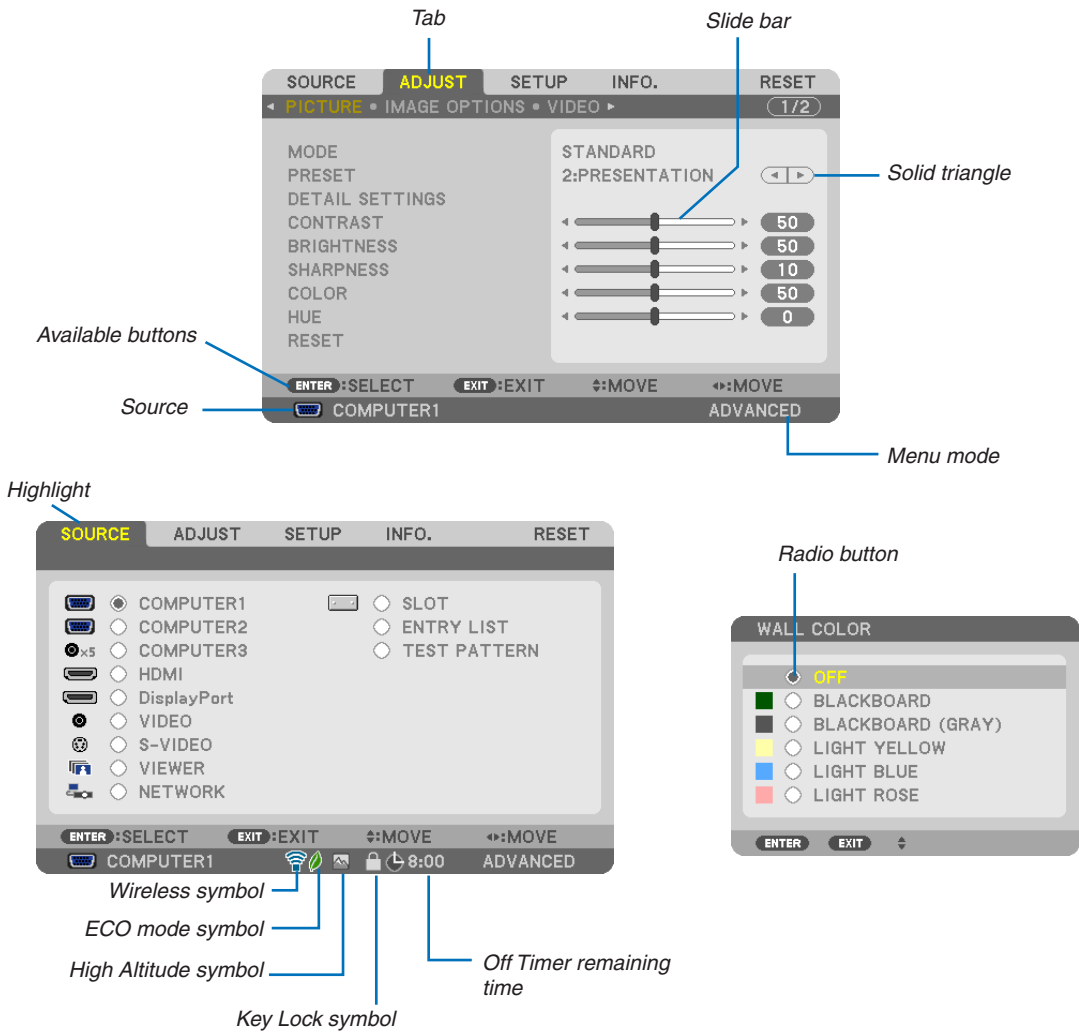

Menu windows or dialog boxes typically have the following elements:

- Highlight..... Indicates the selected menu or item.
- Solid triangle Indicates further choices are available. A highlighted triangle indicates the item is active.
- Tab..... Indicates a group of features in a dialog box. Selecting on any tab brings its page to the front.
- Radio button..... Use this round button to select an option in a dialog box.
- Source Indicates the currently selected source.
- Menu mode Indicates the current menu mode: BASIC or ADVANCED.
- Off Timer remaining time.... Indicates the remaining countdown time when the [OFF TIMER] is preset.
- Slide bar Indicates settings or the direction of adjustment.
- ECO mode symbol..... Indicates [ECO MODE] is set.
- Key Lock symbol Indicates the [CONTROL PANEL LOCK] is enabled.
- High Altitude symbol Indicates the [FAN MODE] is set to [HIGH ALTITUDE] mode.
- Wireless symbol Indicate the wireless LAN connection is enabled.

3 List of Menu Items

• Basic menu items are indicated by shaded area.

Some menu items are not available depending on the input source.

Menu Item		Default	Options		
SOURCE	COMPUTER1	*			
	COMPUTER2	*			
	COMPUTER3	*			
	HDMI	*			
	DisplayPort	*			
	VIDEO	*			
	S-VIDEO	*			
	VIEWER	*			
	NETWORK	*			
	SLOT				
	ENTRY LIST				
	TEST PATTERN				
	ADJUST	MODE	STANDARD	STANDARD, PROFESSIONAL	
PRESET			*	HIGH-BRIGHT, PRESENTATION, VIDEO, MOVIE, GRAPHIC, sRGB	
DETAIL SETTINGS		GENERAL			
		REFERENCE	*	HIGH-BRIGHT, PRESENTATION, VIDEO, MOVIE, GRAPHIC, sRGB	
		GAMMA CORRECTION		DYNAMIC, NATURAL, BLACK DETAIL	
		COLOR TEMPERATURE*1	*	5000, 6500, 7800, 8500, 9300, 10500	
		DYNAMIC CONTRAST	*	OFF, ON	
		Brilliant Color	OFF	OFF, MEDIUM, HIGH	
		WHITE BALANCE			
		CONTRAST R	0		
		CONTRAST G	0		
		CONTRAST B	0		
		BRIGHTNESS R	0		
		BRIGHTNESS G	0		
		BRIGHTNESS B	0		
		SATURATION			
		RED	0		
		GREEN	0		
		BLUE	0		
YELLOW		0			
MAGENTA		0			
CYAN		0			
CONTRAST		50			
BRIGHTNESS		50			
SHARPNESS		10			
COLOR		50			
HUE		0			
RESET					
IMAGE OPTIONS		CLOCK	*		
		PHASE	*		
		HORIZONTAL	*		
		VERTICAL	*		
		BLANKING	*	TOP, BOTTOM, LEFT, RIGHT	
		OVERSCAN	*	AUTO, 0[%], 5[%], 10[%]	
		ASPECT RATIO		*	(COMPUTER1/2/3) AUTO, 4:3, 5:4, 16:9, 15:9, 16:10, NATIVE
				*	(COMPONENT/VIDEO/S-VIDEO) AUTO, 4:3, LETTERBOX, WIDE SCREEN, ZOOM
			*	(COMPONENT/VIDEO/S-VIDEO) AUTO, 4:3 WINDOW, LETTERBOX, WIDE SCREEN, 4:3 FILL	
RESOLUTION		*	-		
VIDEO		NOISE REDUCTION	RANDOM NR	*	OFF, LOW, MEDIUM, HIGH
			MOSQUITO NR	OFF	OFF, LOW, MEDIUM, HIGH
			BLOCK NR	OFF	OFF, ON
		DEINTERLACE	AUTO	AUTO, VIDEO, FILM	
		3D Y/C SEPARATION	ON	OFF, ON	
		DETAIL ENHANCEMENT	*		
		SIGNAL TYPE	RGB	RGB, COMPONENT	
VIDEO LEVEL		AUTO	AUTO, NORMAL, ENHANCED		
LENS MEMORY		STORE			
		MOVE			
		RESET			

* The asterisk (*) indicates that the default setting varies depending on the signal.

*1 When [PRESENTATION] or [HIGH-BRIGHT] is selected in [REFERENCE], the [COLOR TEMPERATURE] is not available.

5. Using On-Screen Menu

SETUP	BASIC	KEYSTONE	HORIZONTAL	0	
			VERTICAL	0	
		CORNERSTONE			
		PIP/PICTURE BY PICTURE	PIP/PBP MODE	PIP	PIP, PICTURE BY PICTURE
			PIP POSITION	BOTTOM-RIGHT	TOP-LEFT, TOP-RIGHT, BOTTOM-LEFT, BOTTOM-RIGHT
			PIP/PBP SOURCE	OFF	OFF, VIDEO, S-VIDEO
		WALL COLOR		OFF	OFF, BLACKBOARD, BLACKBOARD (GRAY), LIGHT YELLOW, LIGHT BLUE, LIGHT ROSE
		LAMP MODE	ECO MODE	OFF	OFF, ON
			LAMP SELECT	DUAL	DUAL, SINGLE, LAMP1 ONLY, LAMP2 ONLY
			LAMP INTERVAL MODE	OFF	OFF, 12 HOURS, 24 HOURS, 1 WEEK
	LAMP SWITCHING TIME		00:00	00:00 - 24:00	
		LAMP SWITCHING DAY	SUN	SUN, MON, TUE, WED, THU, FRI, SAT	
	CLOSED CAPTION		OFF	OFF, CAPTION1, CAPTION2, CAPTION3, CAPTION4, TEXT1, TEXT2, TEXT3, TEXT4	
	OFF TIMER		OFF	OFF, 0:30, 1:00, 2:00, 4:00, 8:00, 12:00, 16:00	
	TOOLS			ADMINISTRATOR MODE, PROGRAM TIMER, TIME, MOUSE	
	LANGUAGE		ENGLISH	ENGLISH, DEUTSCH, FRANÇAIS, ITALIANO, ESPAÑOL, SVENSKA, 日本語	
				DANSK, PORTUGUÊS, ČEŠTINA, MAGYAR, POLSKI, NEDERLANDS, SUOMI NORSK, TÜRKÇE, РУССКИЙ, عربي, Ελληνικά, 中文, 한국어 ROMÂNĂ, HRVATSKA, БЪЛГАРСКИ, INDONESIA, हिन्दी, ไทย	
	MENU	COLOR SELECT		COLOR	COLOR, MONOCHROME
		SOURCE DISPLAY		ON	OFF, ON
		MESSAGE DISPLAY		ON	OFF, ON
		ID DISPLAY		ON	OFF, ON
		ECO MESSAGE		OFF	OFF, ON
		DISPLAY TIME		AUTO 45 SEC	MANUAL, AUTO 5 SEC, AUTO 15 SEC, AUTO 45 SEC
		BACKGROUND		LOGO	BLUE, BLACK, LOGO
	FILTER MESSAGE		OFF	OFF, 100[H], 500[H], 1000[H], 2000[H], 5000[H]	
	INSTALLATION (1)	ORIENTATION		DESKTOP FRONT	DESKTOP FRONT, CEILING REAR, DESKTOP REAR, CEILING FRONT
		SCREEN	SCREEN TYPE	4:3 SCREEN	4:3 SCREEN, 16:9 SCREEN, 16:10 SCREEN
			POSITION*1 (PX800X2 only)	0	[16:9]: -96 to 96, [16:10]: -64 to 64
		GEOMETRIC CORRECTION		OFF	OFF, 1, 2, 3
		MULTI-SCREEN COMP.	MODE	OFF	OFF, ON
			CONTRAST	0	
			BRIGHTNESS	0	
REF. WHITE BALANCE		CONTRAST R	0		
		CONTRAST G	0		
		CONTRAST B	0		
		BRIGHTNESS R	0		
		BRIGHTNESS G	0		
		BRIGHTNESS B	0		
	UNIFORMITY R	0			
	UNIFORMITY B	0			
REF. LENS MEMORY	STORE				
	MOVE				
	RESET				
	LOAD BY SIGNAL				
	FORCED MUTE CALIBRATION				
INSTALLATION (2)	NETWORK SETTINGS			WIRED LAN, WIRELESS LAN, WPS, NETWORK INFORMATION, PROJECTOR NAME, DOMAIN, ALERT MAIL, NETWORK SERVICE	
	CONTROL PANEL LOCK		OFF	OFF, ON	
	SECURITY		OFF	OFF, ON	
	COMMUNICATION SPEED		38400bps	4800bps, 9600bps, 19200bps, 38400bps, 115200bps	
	REMOTE SENSOR		FRONT/BACK	FRONT/BACK, FRONT, BACK	
	CONTROL ID	CONTROL ID NUMBER		1	1-254
CONTROL ID			OFF	OFF, ON	

* The asterisk (*) indicates that the default setting varies depending on the signal.

*1 This item is available when [16:9 SCREEN] or [16:10 SCREEN] is selected for [SCREEN TYPE].

5. Using On-Screen Menu

SETUP	OPTIONS(1)	AUTO ADJUST		NORMAL	OFF, NORMAL, FINE
		FAN MODE		AUTO	MODE: AUTO, HIGH, HIGH ALTITUDE
				FLOOR	SETTING: FLOOR, CEILING, VERTICAL TILT UP, VERTICAL TILT DOWN
		SIGNAL SELECT(COMP3)		RGB/COMPONENT	RGB/COMPONENT, VIDEO
		SEAMLESS SWITCHING (for PX750U2 only)		OFF	OFF, ON
		COLOR SYSTEM	VIDEO	AUTO	AUTO, NTSC3.58, NTSC4.43, PAL, PAL-M, PAL-N, PAL60, SECAM
			S-VIDEO	AUTO	AUTO, NTSC3.58, NTSC4.43, PAL, PAL-M, PAL-N, PAL60, SECAM
	COMPUTER3 (VIDEO)		AUTO	AUTO, NTSC3.58, NTSC4.43, PAL, PAL-M, PAL-N, PAL60, SECAM	
	SLOT POWER	PROJECTOR ON	ON	OFF, ON	
		PROJECTOR STANDBY	ENABLE	DISABLE, ENABLE	
	OPTIONS(2)	STANDBY MODE		POWER-SAVING	NORMAL, POWER-SAVING, NORMAL2
		DIRECT POWER ON		OFF	OFF, ON
		AUTO POWER ON(COMP1/3)		OFF	OFF, COMPUTER1, COMPUTER3
		AUTO POWER OFF		0:30	OFF, 0:05, 0:10, 0:20, 0:30
DEFAULT SOURCE SELECT		LAST	LAST, AUTO, COMPUTER1, COMPUTER2, COMPUTER3, HDMI, DisplayPort, VIDEO, S-VIDEO, VIEWER, NETWORK		
EDGEBLENDING	MODE		OFF	OFF, ON (ON: TOP, BOTTOM, LEFT, RIGHT, BLACK LEVEL)	
INFO.	USAGE TIME	LAMP 1 LIFE REMAINING			
		LAMP 2 LIFE REMAINING			
		LAMP 1 HOURS USED			
		LAMP 2 HOURS USED			
		FILTER HOURS USED			
		TOTAL CARBON SAVINGS			
	SOURCE(1)	INPUT TERMINAL			
		RESOLUTION			
		HORIZONTAL FREQUENCY			
		VERTICAL FREQUENCY			
		SYNC TYPE			
		SYNC POLARITY			
		SCAN TYPE			
		SOURCE NAME			
	ENTRY NO.				
	SOURCE(2)	SIGNAL TYPE			
		VIDEO TYPE			
		BIT DEPTH			
		VIDEO LEVEL			
		LINK RATE			
	WIRED LAN	LINK LANE			
		IP ADDRESS			
		SUBNET MASK			
		GATEWAY			
		MAC ADDRESS			
	WIRELESS LAN(1)	IP ADDRESS			
		SUBNET MASK			
		GATEWAY			
		MAC ADDRESS			
	WIRELESS LAN(2)	SSID			
		NETWORK TYPE			
		WEP/WPA			
		CHANNEL			
	VERSION (1)	SIGNAL LEVEL			
		FIRMWARE			
		DATA			
VERSION (2)	FIRMWARE2				
	FIRMWARE3				
OTHERS	PROJECTOR NAME				
	MODEL NO.				
	SERIAL NUMBER				
	LAN UNIT TYPE				
	CONTROL ID (when [CONTROL ID] is set)				
RESET	CURRENT SIGNAL				
	ALL DATA				
	ALL DATA(INCLUDING ENTRY LIST)				
	CLEAR LAMP 1 HOURS				
	CLEAR LAMP 2 HOURS				
CLEAR FILTER HOURS					

④ Menu Descriptions & Functions [SOURCE]

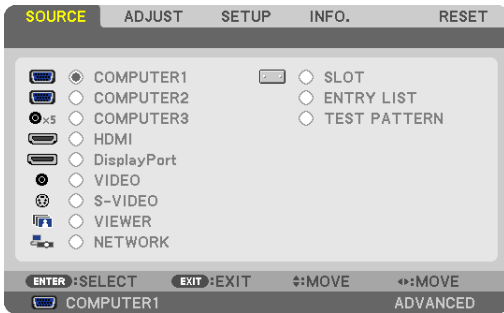

COMPUTER 1, 2, and 3

Selects the computer connected to your COMPUTER 1, 2, or COMPUTER 3 input connector signal.

NOTE: When the component input signal is connected to the COMPUTER 1 IN, COMPUTER 2 IN, or COMPUTER 3 IN connector, select [COMPUTER1], [COMPUTER2] or [COMPUTER3] respectively. The projector automatically determines whether the COMPUTER1, 2, or 3 input signal is an RGB or component signal.

HDMI

Selects the HDMI compatible equipment connected to your HDMI IN connector.

DisplayPort

Projects the image of the device connected to the DisplayPort input connector.

VIDEO

Selects what is connected to your VIDEO input-VCR, DVD player or document camera.

S-VIDEO

Selects what is connected to your S-VIDEO input-VCR or DVD player.

NOTE: A frame may freeze for a brief period of time when a video is played back in fast-forward or fast-rewind with a Video or S-Video source.

VIEWER

This feature enables you to make presentations using a USB memory that contains slides.
(→ page 73 “4. Using the Viewer”)

NETWORK

Selects a signal from the LAN port (RJ-45) or the installed USB wireless LAN unit (optional for models for Europe, Australia, Asia and other countries than North America).

SLOT (for optional board)

Selects a signal from the optional board (SB-01HC or other NEC’s interface boards) when it is installed.

ENTRY LIST

Displays a list of signals. See the following pages.

TEST PATTERN

Displays the test pattern.

NOTE:

• *The test pattern can be displayed even when the menu is displayed. Unavailable menu items are displayed in grey.*

Using the Entry List

When any source or lens memory adjustments are made, the adjustments are automatically registered in the Entry List. The (adjustment values of) registered signals can be loaded from the Entry List whenever necessary. However, only up to 100 patterns can be registered in the Entry List. When 100 patterns have been registered in the Entry List, an error message is then displayed and no additional patterns can be registered. You should thus delete (adjustment values of) signals that are no longer needed.

Displaying the Entry list

1. Press the MENU button.

The menu will be displayed.

2. Press the ◀ or ▶ button to select [SOURCE].

The SOURCE list will be displayed.

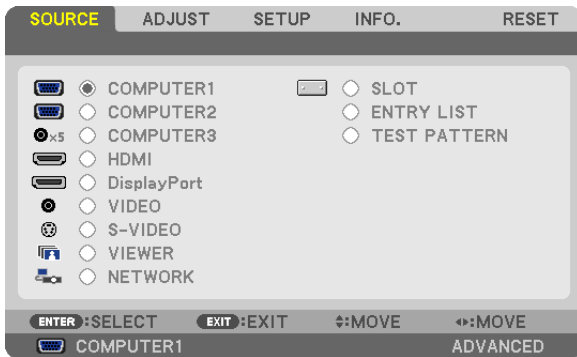

3. Use the ◀, ▶, ▲, or ▼ to select [ENTRY LIST] and press the ENTER button.

The ENTRY LIST windows will be displayed.

If the ENTRY LIST window is not displayed, switch the menu to [ADVANCED].

To switch the menu between [ADVANCED] and [BASIC], select [APPLICATION MENU] → [TOOLS] → [ADMINISTRATOR MODE]. (→ page 157)

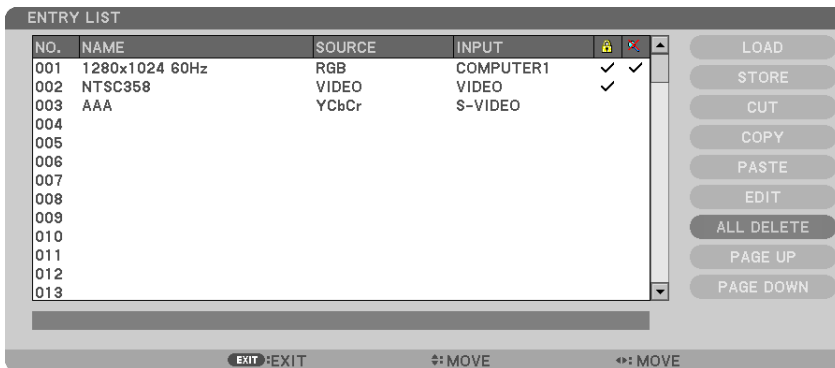

Entering the currently projected signal into the Entry List [STORE]

1. Press the ▲ or ▼ button to select any number.
2. Press the ◀ or ▶ button to select [STORE] and press the ENTER button.

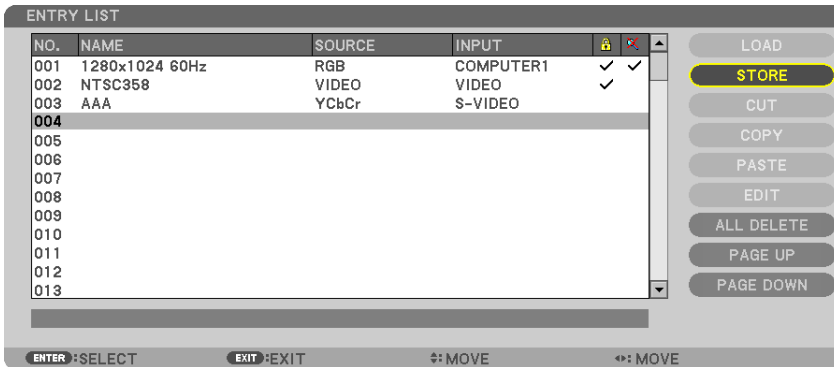

Calling up a signal from the Entry List [LOAD]

Press the ▲ or ▼ button to select a signal and press the ENTER button.

Editing a signal from the Entry List [EDIT]

1. Press the ▲ or ▼ button to select a signal you wish to edit.
2. Press the ◀, ▶, ▲, or ▼ button to select [EDIT] and press the ENTER button.

The Edit window will be displayed.

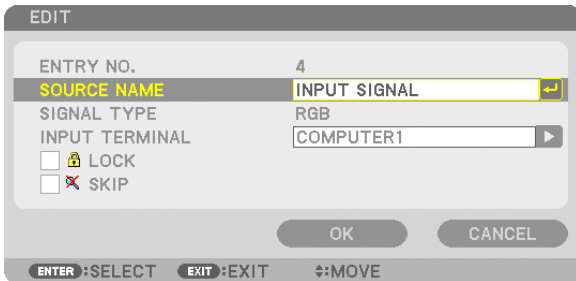

SOURCE NAME	Enter a signal name. Up to 18 alphanumeric characters can be used.
INPUT TERMINAL	Select the input source.
LOCK	Set so that the selected signal cannot be deleted when [ALL DELETE] is executed. The changes made after LOCK execution cannot be saved.
SKIP	Set so that the selected signal will be skipped during auto search.

3. Set the above items and select [OK] and press the ENTER button.

NOTE: The input terminal cannot be changed to the currently projected signal.

Cutting a signal from the Entry List [CUT]

1. Press the ▲ or ▼ button to select a signal you wish to delete.
2. Press the ◀, ▶, ▲, or ▼ button to select [CUT] and press the ENTER button.

The signal will be deleted from the Entry List and the deleted signal will be displayed on the clipboard at the bottom of the Entry List.

NOTE:

- The currently projected signal cannot be deleted.
 - When the locked signal is selected, it will be displayed in gray which indicates it is not available.
-

TIP:

- Data on the clipboard can be passed onto the Entry List.
- Data on the clipboard will not be lost after the Entry List is closed.

Copying and pasting a signal from the Entry List [COPY] / [PASTE]

1. Press the ▲ or ▼ button to select a signal you wish to copy.
2. Press the ◀, ▶, ▲, or ▼ button to select [COPY] and press the ENTER button.
The copied signal will be displayed on the clipboard at the bottom of the Entry List.
3. Press the ◀ or ▶ button to move to the list.
4. Press the ▲ or ▼ button to select a signal.
5. Press the ◀, ▶, ▲, or ▼ button to select [PASTE] and press the ENTER button.

Data on the clipboard will be pasted to the signal.

Deleting all the signals from the Entry List [ALL DELETE]

1. Press the ◀, ▶, ▲, or ▼ button to select [ALL DELETE] and press the ENTER button.
The confirmation message will be displayed.
2. Press the ◀ or ▶ button to select [YES] and press the ENTER button.

NOTE: The locked signal cannot be deleted.

5 Menu Descriptions & Functions [ADJUST]

[PICTURE]

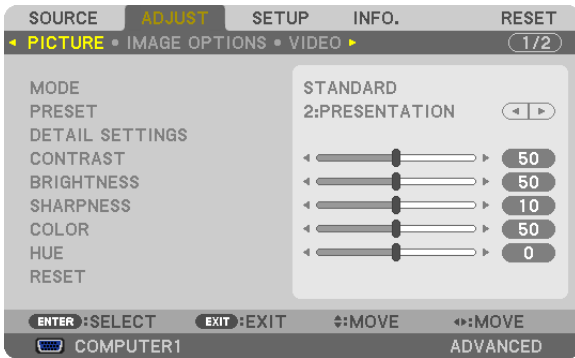

[MODE]

This function allows you to determine how to save settings for [DETAIL SETTINGS] of [PRESET] for each input.

STANDARD..... Saves settings for each item of [PRESET] (Preset 1 through 6)

PROFESSIONAL..... Saves all the settings of [PICTURE] for each input.

[PRESET]

This function allows you to select optimized settings for your projected image.

You can adjust neutral tint for yellow, cyan or magenta.

There are six factory presets optimized for various types of images. You can also use [DETAIL SETTINGS] to set user adjustable settings to customize each gamma or color.

Your settings can be stored in [PRESET 1] to [PRESET 6].

HIGH-BRIGHT..... Recommended for use in a brightly lit room.

PRESENTATION..... Recommended for making a presentation using a PowerPoint file.

VIDEO..... Recommended for typical TV program viewing.

MOVIE..... Recommended for movies.

GRAPHIC..... Recommended for graphics.

sRGB..... Standard color values

[DETAIL SETTINGS]

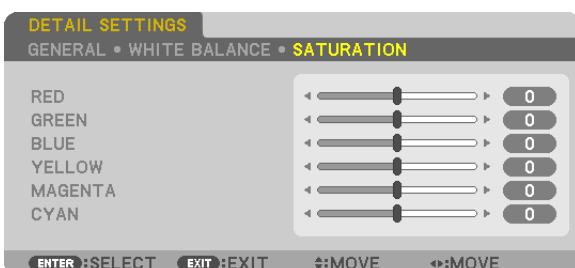
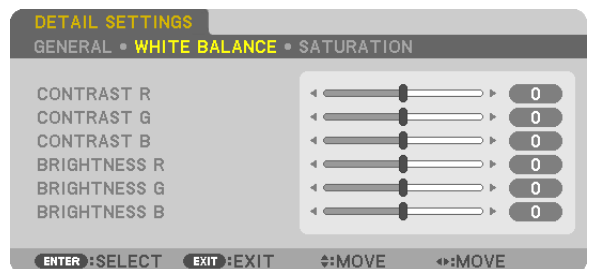
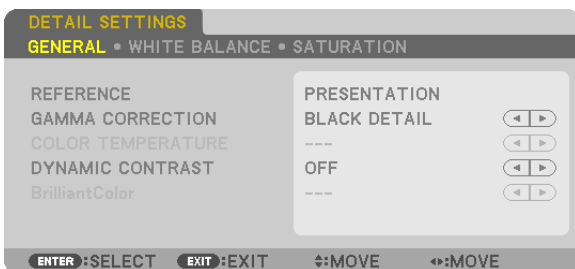

[GENERAL]

Storing Your Customized Settings [REFERENCE]

This function allows you to store your customized settings in [PRESET 1] to [PRESET 6].

First, select a base preset mode from [REFERENCE], then set [GAMMA CORRECTION] and [COLOR TEMPERATURE].

HIGH-BRIGHT Recommended for use in a brightly lit room.

PRESENTATION Recommended for making a presentation using a PowerPoint file.

VIDEO Recommended for typical TV program viewing.

MOVIE Recommended for movies.

GRAPHIC Recommended for graphics.

sRGB Standard color values.

Selecting Gamma Correction Mode [GAMMA CORRECTION]

Each mode is recommended for:

DYNAMIC Creates a high-contrast picture.

NATURAL Natural reproduction of the picture.

BLACK DETAIL Emphasizes detail in dark areas of the picture.

Adjusting Color Temperature [COLOR TEMPERATURE]

This option allows you to select the color temperature of your choice.

NOTE:

- When [PRESENTATION] or [HIGH-BRIGHT] is selected in [REFERENCE], this function is not available.
 - When a color option other than [OFF] is selected for [WALL COLOR], this function is not available.
-

Adjusting Brightness and Contrast [DYNAMIC CONTRAST]

This function allows you to adjust the contrast ratio optically using the built-in iris.

To increase the contrast ratio, select [ON].

NOTE:

- From the on-screen menu [DYNAMIC CONTRAST] is available only when [DUAL] is selected for [LAMP SELECT] from [LAMP MODE]. (→ page 119)
-

Adjusting Brightness of White Areas [BrilliantColor]

This function allows you to adjust the brightness of the white areas. As the picture becomes dim, it looks more natural.

OFF Turns off the BrilliantColor feature.

MEDIUM Increases brightness of the white areas.

HIGH Increases more brightness of the white areas.

NOTE:

- [BrilliantColor] is not available when [HIGH-BRIGHT] or [PRESENTATION] is selected for [REFERENCE].
-

Adjusting White Balance [WHITE BALANCE]

This allows you to adjust the white balance. Contrast for each color (RGB) to adjust the white level of the screen; Brightness for each color (RGB) is used to adjust the black level of the screen.

[SATURATION]

Corrects the saturation for all signals.

Adjusts the saturation for the colors red, green, blue, yellow, magenta and cyan.

- RED Adjusts the color in red areas, centered around the red.
- GREEN Adjusts the color in green areas, centered around the green.
- BLUE Adjusts the color in blue areas, centered around the blue.
- YELLOW Adjusts the color in yellow areas, centered around the yellow.
- MAGENTA Adjusts the color in magenta areas, centered around the magenta.
- CYAN Adjusts the color in cyan areas, centered around the cyan.

[CONTRAST]

Adjusts the intensity of the image according to the incoming signal.

[BRIGHTNESS]

Adjusts the brightness level or the back raster intensity.

[SHARPNESS]

Controls the detail of the image.

[COLOR]

Increases or decreases the color saturation level.

[HUE]

Varies the color level from +/- green to +/- blue. The red level is used as reference.

Input signal	CONTRAST	BRIGHTNESS	SHARPNESS	COLOR	HUE
COMPUTER/DisplayPort/HDMI (RGB)	Yes	Yes	Yes	No (Yes: SDTV/HDTV)	No (Yes: SDTV/HDTV)
COMPUTER/DisplayPort/HDMI (COMPONENT)	Yes	Yes	Yes	Yes	Yes
VIDEO/S-VIDEO/COMPONENT	Yes	Yes	Yes	Yes	Yes
VIEWER/NETWORK	Yes	Yes	Yes	No	No

Yes = Adjustable, No = Not adjustable

[RESET]

The settings and adjustments for [PICTURE] will be returned to the factory settings with the exception of the following; Preset numbers and [REFERENCE] within the [PRESET] screen.

The settings and adjustments under [DETAIL SETTINGS] within the [PRESET] screen that are not currently selected will not be reset.

[IMAGE OPTIONS]

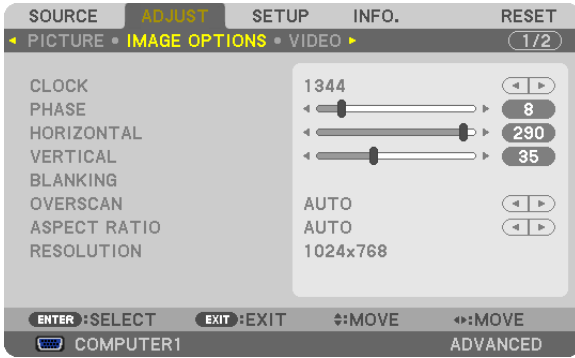

Adjusting Clock and Phase [CLOCK/PHASE]

This allows you to manually adjust CLOCK and PHASE.

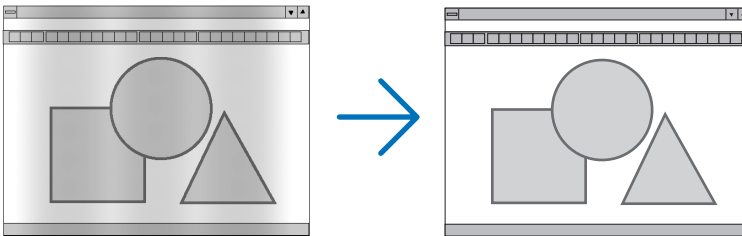

CLOCK Use this item to fine tune the computer image or to remove any vertical banding that might appear. This function adjusts the clock frequencies that eliminate the horizontal banding in the image.

This adjustment may be necessary when you connect your computer for the first time.

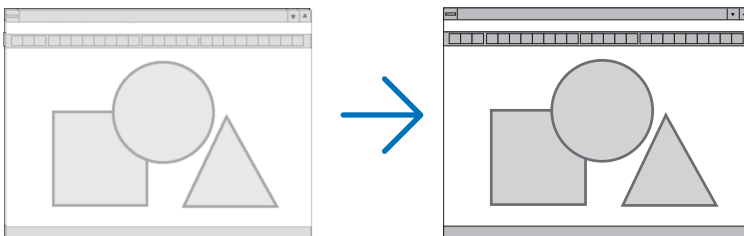

PHASE Use this item to adjust the clock phase or to reduce video noise, dot interference or cross talk. (This is evident when part of your image appears to be shimmering.)

Use [PHASE] only after the [CLOCK] is complete.

NOTE: The [CLOCK] and [PHASE] items are available for RGB signals only.

Adjusting Horizontal/Vertical Position [HORIZONTAL/VERTICAL]

Adjusts the image location horizontally and vertically.

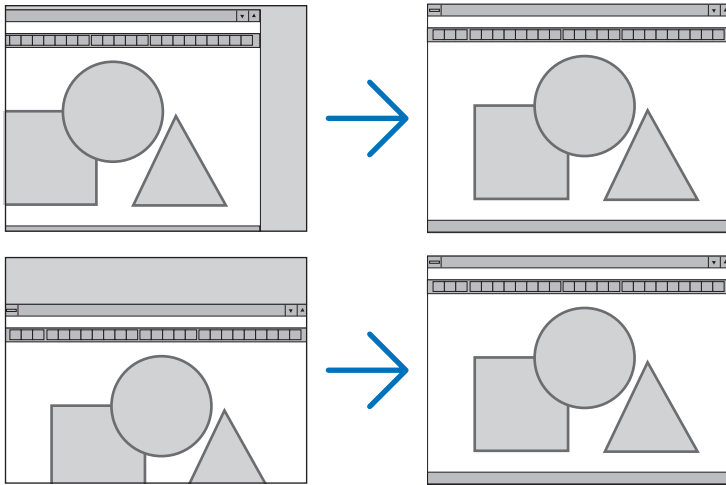

- An image can be distorted during the adjustment of [CLOCK] and [PHASE]. This is not malfunction.
- The adjustments for [CLOCK], [PHASE], [HORIZONTAL], and [VERTICAL] will be stored in memory for the current signal. The next time you project the signal with the same resolution, horizontal and vertical frequency, its adjustments will be called up and applied.

To delete adjustments stored in memory, from the menu, you select [RESET] → [CURRENT SIGNAL] and reset the adjustments.

[BLANKING]

Adjusts the display range (blanking) at the top, bottom, left and right edges of the input signal.

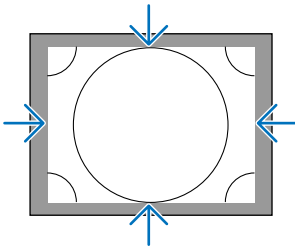

Selecting Overscan Percentage [OVERSCAN]

Select overscan percentage (Auto, 0%, 5% and 10%) for signal.

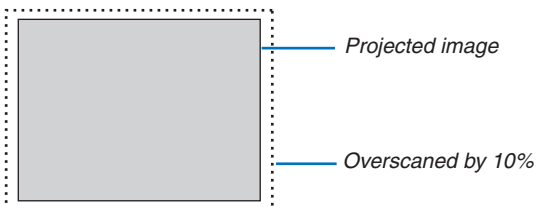

NOTE:

- The [OVERSCAN] item is not available:
 - when [NATIVE] is selected for [ASPECT RATIO].
 - when [VIEWER] or [NETWORK] is selected for [SOURCE]

Selecting the Aspect Ratio [ASPECT RATIO]

Use this function to select the screen's vertical:horizontal aspect ratio.

Select the screen type (4:3 screen, 16:9 screen or 16:10 screen) at the screen setting before setting the aspect ratio. (→ page 123)

The projector automatically identifies the signal being input and sets the optimum aspect ratio.

For Computer signal

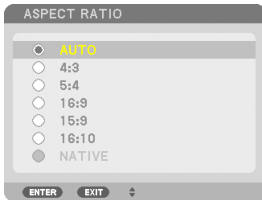

For Component/Video/S-Video signals

When the screen type is set to 4:3

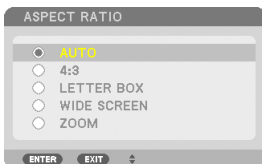

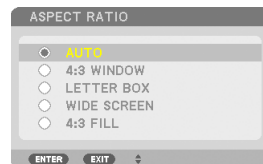

When the screen type is set to 16:9 or 16:10

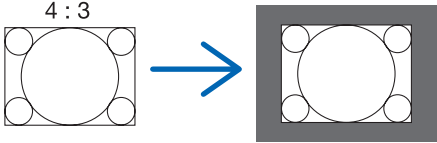
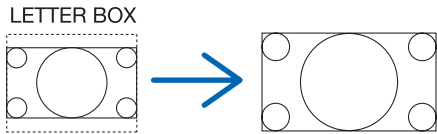
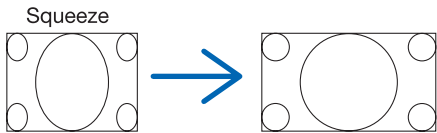

	Resolution	Aspect Ratio
VGA	640 × 480	4:3
SVGA	800 × 600	4:3
XGA	1024 × 768	4:3
WXGA	1280 × 768	15:9
WXGA	1280 × 800	16:10
HD(FWXGA)	1366 × 768	approx. 16:9
WXGA+	1440 × 900	16:10
SXGA	1280 × 1024	5:4
SXGA+	1400 × 1050	4:3
WXGA++	1600 × 900	16:9
UXGA	1600 × 1200	4:3
WSXGA+	1680 × 1050	16:9
FHD(1080P)	1920 × 1080	16:9
WUXGA	1920 × 1200	16:10

Options	Function
AUTO	The projector will automatically determine the incoming signal and display it in its aspect ratio. The projector may erroneously determine the aspect ratio depending on its signal. If this occurs, select the appropriate aspect ratio from the following.
4:3	The image is displayed in 4:3 aspect ratio.
5:4	The image is displayed in 5:4 aspect ratio.
16:9	The image is displayed in 16:9 aspect ratio.
15:9	The image is displayed in 15:9 aspect ratio.
16:10	The image is displayed in 16:10 aspect ratio.

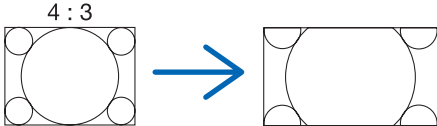
<p>NATIVE</p>	<p>The projector displays the current image in its true resolution when the incoming computer signal has a lower or higher resolution than the projector's native resolution. (→ page 2, 224) When the incoming computer signal has a higher resolution than the projector's native resolution, the center of an image will be displayed.</p>  <p>The diagram shows a square frame labeled '4 : 3' containing a circle and four smaller circles at the corners. A blue arrow points to a larger square frame where the same circle and corner circles are centered, with a dark grey border around them.</p>
<p>LETTER BOX</p>	<p>The image of a letterbox signal (16:9) is stretched equally in the horizontal and vertical directions to fit the screen.</p>  <p>The diagram shows a rectangular frame labeled 'LETTER BOX' containing a circle and four smaller circles at the corners. A blue arrow points to a square frame where the circle and corner circles are stretched to fit the square frame.</p>
<p>WIDE SCREEN</p>	<p>The image of a squeeze signal(16:9) is stretched left and right in 16:9.</p>  <p>The diagram shows a rectangular frame labeled 'Squeeze' containing a circle and four smaller circles at the corners. A blue arrow points to a wider rectangular frame where the circle and corner circles are stretched horizontally.</p>
<p>ZOOM</p>	<p>The image of a squeeze signal (16:9) is stretched left and right in 4:3. Parts of the displayed image are cropped at the left and right edges and therefore not visible.</p>  <p>The diagram shows a rectangular frame labeled 'Squeeze' containing a circle and four smaller circles at the corners. A blue arrow points to a square frame where the circle and corner circles are stretched horizontally, with the left and right edges of the original image being cropped.</p>
<p>4:3 FILL</p>	<p>The image of a signal(4:3) is stretched left and right in 16:9.</p>  <p>The diagram shows a square frame labeled '4 : 3' containing a circle and four smaller circles at the corners. A blue arrow points to a wider rectangular frame where the circle and corner circles are stretched horizontally to fill the width of the frame.</p>

- TIP:**
- Image position can be adjusted vertically using [POSITION] when the [16:9], [15:9], or [16:10] aspect ratios are selected.
 - The term “letterbox” refers to a more landscape-oriented image when compared to a 4:3 image, which is the standard aspect ratio for a vide source.
 The letterbox signal has aspect ratios with the vista size “1.85:1” or cinema scope size “2.35:1” for movie film.
 - The term “squeeze” refers to the compressed image of which aspect ratio is converted from 16:9 to 4:3.

[RESOLUTION]

This function sets the resolution of a projected image if auto-detect fails to work well.

[VIDEO]

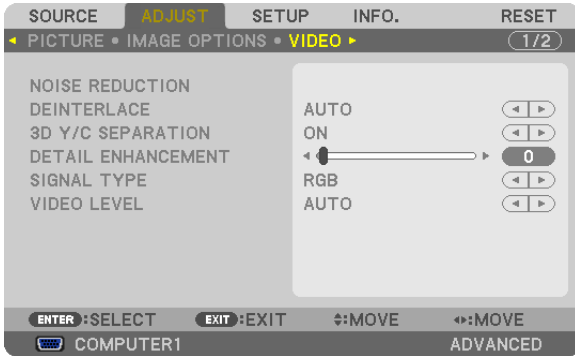

Using Noise Reduction [NOISE REDUCTION]

This function is used to reduce video noise.

- RANDOM NR Reduces flickering random noise in an image.
- MOSQUITO NR Reduces mosquito noise that appears around the edges of an image during DVD playback.
- BLOCK NR Reduces block noise or mosaic-like patterns by selecting ON.

Selecting Interlaced Progressive Conversion Process Mode [DEINTERLACE]

This function allows you to select an interlaced-to-progressive conversion process for video signals.

- AUTO Determines an appropriate interlaced-to-progressive conversion process automatically.
- VIDEO Applies a normal interlaced-to-progressive conversion process.
- FILM Applies the automatic detection mode for telecine signals. This option is recommended for a movie picture.

NOTE: This function is not available with RGB signals.

Turning On or Off the 3D Dimensional Separation [3D Y/C SEPARATION]

When projecting an image from a VIDEO input, set to ON to project the highest quality image.

- OFF Turns off the 3 dimensional separation feature.
- ON Turns on the 3 dimensional separation feature.

NOTE: Only available for NTSC 3.58 video signals.

[DETAIL ENHANCEMENT]

This function enhances the contours of the image when projecting component signals.

*NOTE:
This function may not be available depending on the signal or screen setting.*

[SIGNAL TYPE]

The projector automatically identifies whether the COMPUTER 1, COMPUTER 2 or COMPUTER 3* input signals are RGB or component signals to project the image. If the colors are unnatural, however, try switching the setting.
* For COMPUTER 3, the computer signal and video signal can be selected at SIGNAL SELECT(COMP3).

- RGB Switches to the RGB input.
- COMPONENT Switches to the component signal input.

[VIDEO LEVEL]

This function selects video signal level when the projector's HDMI and DisplayPort input connectors and an external device are connected.

- AUTO The video level is switched automatically based on the information from the device outputting the signal.
Depending on the connected device, this setting may not be made properly. In this case, switch to "NORMAL" or "ENHANCED" from the menu and view with the optimum setting.
- NORMAL..... This disables the enhanced mode.
- ENHANCED This improves the image's contrast, expressing the dark and light sections more dynamically.

Using the Lens Memory Function [LENS MEMORY]



This function serves to store the adjusted values for each input signal when using the LENS SHIFT, ZOOM and FOCUS buttons of the projector. Adjusted values can be applied to the signal you selected. This will eliminate the need to adjust lens shift, focus, and zoom at the time of source selection.

- STORE Stores the current adjusted values in memory for each input signal.
- MOVE Applies the adjusted values to the current signal.
- RESET..... Returns the adjusted values to the last condition.

NOTE:

- The lens shift, zoom, and focus adjustments can be performed with the remote control. (→ page 24, 25, 28)
- To store adjusted values common to all the input sources, use the REF. LENS MEMORY function. See page 47, 125.
- Lens memory adjustments will be automatically registered the ENTRY LIST. These lens memory adjustments can be loaded from the ENTRY LIST. (→ page 106)
Note that performing [CUT] or [ALL DELETE] in the ENTRY LIST will delete lens memory adjustments as well as source adjustments. This deletion will not take effect until other adjustments is loaded.

6 Menu Descriptions & Functions [SETUP]

[BASIC]



Correcting Vertical Keystone Distortion Manually [KEYSTONE]

You can correct vertical distortion manually. (→ page 30)

TIP: When this option is highlighted, pressing the ENTER button will display its slide bar for adjustment.

Selecting Cornerstone Mode [CORNERSTONE]



This option allows you to correct trapezoidal distortion.

Selecting this item will display the Cornerstone adjustment screen. (→ page 39)

NOTE: The [CORNERSTONE] item is not available when [KEYSTONE] or [GEOMETRIC CORRECTION] is selected.

Using the PIP/PICTURE BY PICTURE Function [PIP/PICTURE BY PICTURE]

This function allows you to view two different signals simultaneously. (→ page 42)

MODE:

This option allows you to select two modes: PIP and PICTURE BY PICTURE.

PIP: This option allows you to view a sub picture in the main picture.

PICTURE BY PICTURE: This allows you to view two pictures side by side.

POSITION:

When [PIP] is selected for [MODE], this option allows you to select the position of a sub picture in the main picture. The options are: TOP-LEFT, TOP-RIGHT, BOTTOM LEFT, and BOTTOM RIGHT.

NOTE: The [POSITION] cannot be selected when [PICTURE BY PICTURE] is selected.

SOURCE:

This option allows you to select a sub picture signal.

The options are: OFF, VIDEO and S-VIDEO.

Selecting [OFF] will cancel the PIP/PICTURE BY PICTURE mode and return to the normal screen.

Using the Wall Color Correction [WALL COLOR]

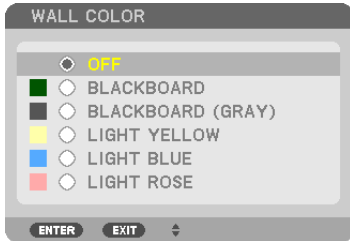

This function allows for quick adaptive color correction in applications where the screen material is not white.

[LAMP MODE]

The projector is designed to accept two lamps (dual lamp system).

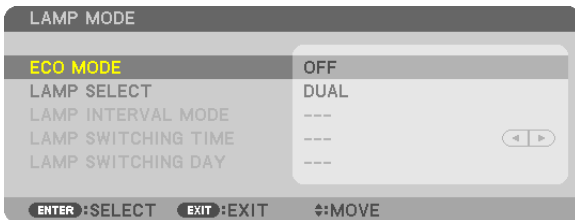

This dual lamp system provides prolonged lamp life or high brightness or extra lamp (Extended life lamp). The [LAMP MODE] item has 3 options: [ECO MODE], [LAMP SELECT], and [LAMP INTERVAL MODE].

NOTE: Be sure to use the same lamp type for both lamp 1 and 2.

Setting Eco Mode [ECO MODE]

The ECO MODE increases lamp life, while lowering power consumption and cutting down on CO₂ emissions. Two brightness modes of the lamp can be selected: [OFF] and [ON] modes.

(→ page 37)

Selecting the lamp to be used [LAMP SELECT]

This feature allows you to select which lamp to be used.

NOTE: This option is not displayed in the Basic menu.

- DUAL Select to use the two lamps at the same time to increase brightness.
- SINGLE Lights either lamp 1 or 2 whichever was used last. This option also selects Lamp 1 or Lamp 2 according to the time preset with Lamp Interval.
- LAMP 1 ONLY Select to use the Lamp 1 of the two lamps. (Lamp 1 on the right of the rear side)
- LAMP 2 ONLY Select to use the Lamp 2 of the two lamps. (Lamp 2 on the left of the rear side)

TIP:

On Selecting [SINGLE] for [LAMP SELECT]

- A lamp has a property that its brightness gradually decreases with age. To keep the brightness of two lamps on the same level as much as possible, select [SINGLE] for [LAMP SELECT].
- Lamp life will decrease when shorter lamp interval times are set within the on-screen menu. You are recommended to extend the lamp interval time.

Setting the lamp interval [LAMP INTERVAL MODE]

This allows you to specify the time for switching between the two lamps alternately. This option is available only when [SINGLE] is selected for [LAMP SELECT].

- OFF Turns off the lamp interval mode setting.
- 12 HOURS/24 HOURS/1 WEEK
..... Select one of these three options for interval time.

NOTE:

- This function is available only when [SINGLE] is selected for [LAMP SELECT].
- Before setting [LAMP INTERVAL MODE], [LAMP SWITCHING TIME] or [LAMP SWITCHING DAY], make sure that the current date and time is set for the projector. To set the date and time for the projector, select [APPLICATION MENU] → [TOOLS] → [DATE AND TIME] from the menu. (→ page 161)

Setting the time for changing the lamp [LAMP SWITCHING TIME]

This allows you to set the time for changing the lamp.

Example – When [SINGLE] is selected for [LAMP SELECT] and [24 HOURS] for [LAMP INTERVAL MODE]:

- This indicates the lamp is turned on.
- This indicates the lamp is turned off.

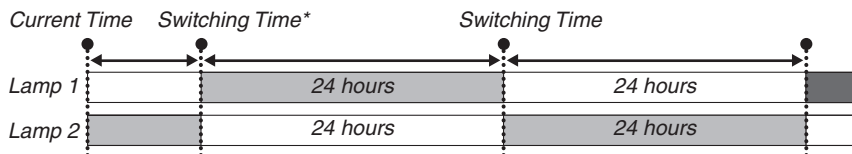

(*) After setting the Current Time, if the value between Current Time and Switching Time is less than five (5) minutes, the first lamp switching instance does not take place.

Setting the day for changing the lamp [LAMP SWITCHING DAY]

This allows you to set the day for changing the lamp.

The options are: SUN (Sunday), MON (Monday), TUE (Tuesday), WED (Wednesday), THU (Thursday), FRI (Friday), and SAT (Saturday).

NOTE:

- *This function is available only when [1 WEEK] is selected for [LAMP INTERVAL MODE].*
-

Setting Closed Caption [CLOSED CAPTION]

This option sets several closed caption modes that allow text to be superimposed on the projected image of Video or S-Video.

OFF This exits the closed caption mode.

CAPTION 1-4 Text is superimposed.

TEXT 1-4..... Text is displayed.

Using Off Timer [OFF TIMER]

- 1. Select your desired time between 30 minutes and 16 hours: OFF, 0:30, 1:00, 2:00, 4:00, 8:00, 12:00, 16:00.**
- 2. Press the ENTER button on the remote control.**
- 3. The remaining time starts counting down.**
- 4. The projector will turn off after the countdown is complete.**

NOTE:

- *To cancel the preset time, set [OFF] for the preset time or turn off the power.*
 - *When the remaining time reaches 3 minutes before the projector is turned off, the [THE PROJECTOR WILL TURN OFF WITHIN 3 MINUTES] message will be displayed on the bottom of the screen.*
-

[TOOLS]

See "APPLICATION MENU" on page 139.

Selecting Menu Language [LANGUAGE]

You can choose one of 27 languages for on-screen instructions.

NOTE: *Your setting will not be affected even when [RESET] is done from the menu.*

[MENU]

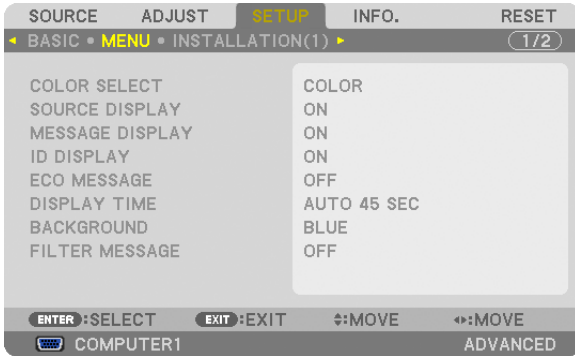

Selecting Menu Color [COLOR SELECT]

You can choose between two options for menu color: COLOR and MONOCHROME.

Turning On / Off Source Display [SOURCE DISPLAY]

This option turns on or off input name display such as COMPUTER 1, COMPUTER2, COMPUTER3, HDMI, Display-Port, VIDEO, S-VIDEO, VIEWER, NETWORK to be displayed on the top right of the screen.

Turning messages on and off [MESSAGE DISPLAY]

This option selects whether or not to display projector messages at the bottom of the projected image. Even when "OFF" is selected, the security lock warning is displayed. The security lock warning turns off when the security lock is canceled.

Turning ON/OFF Control ID [ID DISPLAY]

ID DISPLAY This option turns on or off the ID number which is displayed when the ID SET button on the remote control is pressed. (→ page 126)

Turning On / Off Eco Message [ECO MESSAGE]

This option turns on or off the following messages when the projector is turned on.

The Eco Message prompts the user to save energy. When [OFF] is selected for [ECO MODE], you will get a message to prompt you to select [ON] for [ECO MODE].

When [ON] is selected for [ECO MODE]

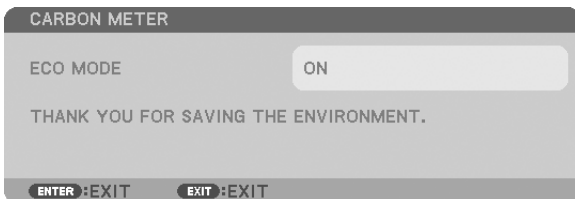

To close the message, press any one of the buttons. The message will disappear if no button operation is done for 30 seconds.

When [OFF] is selected for [ECO MODE]

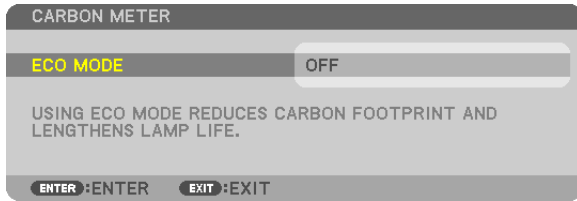

Pressing the ENTER button will display the [ECO MODE] screen. (→ page 37)
To close the message, press the EXIT button.

Selecting Menu Display Time [DISPLAY TIME]

This option allows you to select how long the projector waits after the last touch of a button to turn off the menu. The preset choices are [MANUAL], [AUTO 5 SEC], [AUTO 15 SEC], and [AUTO 45 SEC]. The [AUTO 45 SEC] is the factory preset.

Selecting a Color or Logo for Background [BACKGROUND]

Use this feature to display a blue/black screen or logo when no signal is available. The default background is [LOGO].

NOTE:

- Even when the background logo is selected, if two pictures are displayed in [PIP/PICTURE BY PICTURE] mode, the blue background is displayed without the logo when there is no signal.

Selecting Interval Time for Filter Message [FILTER MESSAGE]

This option allows you to select the time preference between displaying the message for cleaning the filters. Clean the filter when you get the message “PLEASE CLEAN FILTER.” (→ page 179)
Six options are available: OFF, 100[H], 500[H], 1000[H], 2000[H], 5000[H]
The default setting is [OFF].

NOTE: Your setting will not be affected even when [RESET] is done from the menu.

[INSTALLATION(1)]

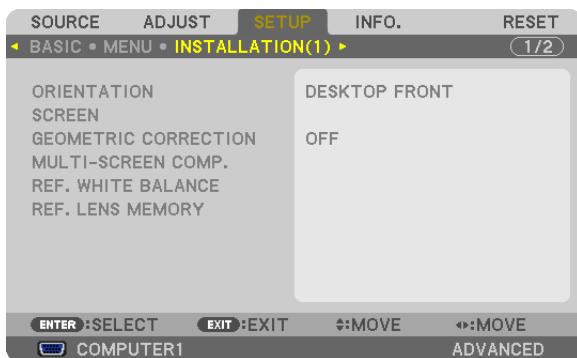

Selecting Projector Orientation [ORIENTATION]

This reorients your image for your type of projection. The options are: desktop front projection, ceiling rear projection, desktop rear projection, and ceiling front projection.

NOTE:

This projector is a tilt-free projector with which it is possible to project images on the ceiling (upward) or floor (downward). When changing the projector orientation, also change the [SETTING] option of [FAN MODE] accordingly. (→ page 128)

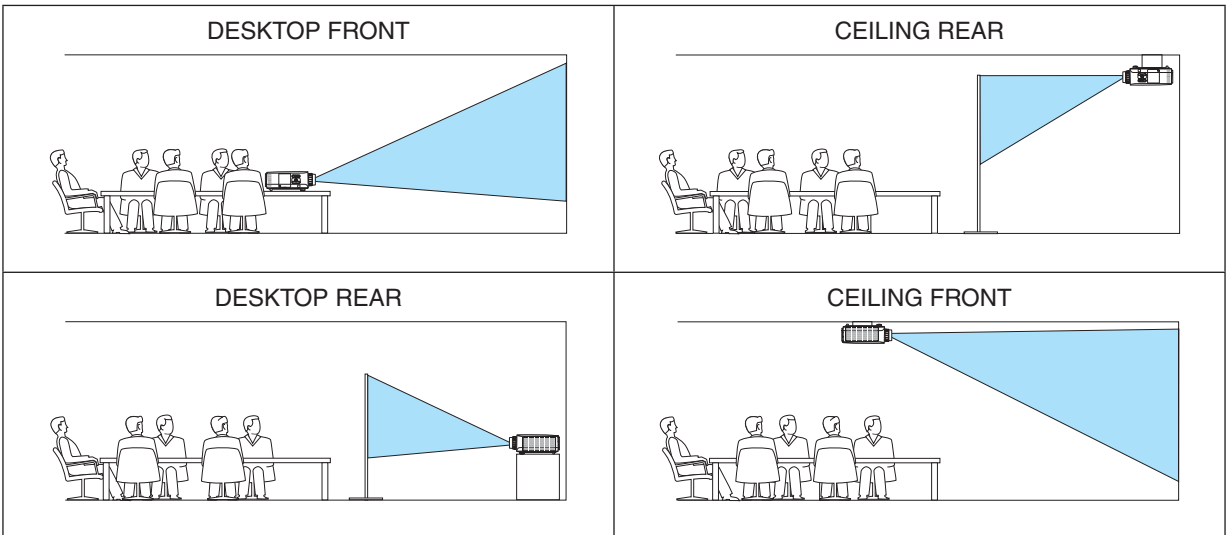

Selecting Aspect Ratio and Position for Screen [SCREEN]

Screen type [SCREEN TYPE]	Sets the aspect ratio of the projection screen.	
	4:3 screen	For a screen with a 4:3 aspect ratio
	16:9 screen	For a screen with a 16:9 aspect ratio
	16:10 screen	For a screen with a 16:10 aspect ratio
Display position [POSITION] (for PX800X2 only)	When the screen type is set to 16:9 or 16:10, adjusts the vertical position of the display range.	
	<p>Downward</p> <p>Upward</p>	

NOTE:

- After changing the screen type, check the setting of [ASPECT RATIO] in the menu. (→ page 113)

Using Geometric Correction [GEOMETRIC CORRECTION]

This feature retrieves geometric data registered in the projector memory. Three presets of geometric data have been registered. To turn off this feature, select [OFF].

NOTE:

- The [KEYSTONE] and [CORNERSTONE] adjustments are not available when geometric data is applied.
- To clear your geometric data, press the 3D REFORM button for a minimum of 2 seconds.
- The [GEOMETRIC CORRECTION] feature can cause an image to be slightly blurred because the correction is made electronically.

Using Multi-Screen Compensation [MULTI-SCREEN COMP.]

This feature allows you to match brightness of images projected from multiple projectors.

Before using [MULTI-SCREEN COMP.], you need to match color of images projected from multiple projectors.

MODE OFF: Turns off this function.

ON: Turns on this function. The [BRIGHTNESS] and the [CONTRAST] can be adjusted.

CONTRAST Adjusts the bright part of the picture.

BRIGHTNESS..... Adjusts the dark part of the picture.

Adjusting

1. Prepare black and white images so that the images can be displayed on the computer screen.

2. Display the black image on the computer screen, and project the image from the projector.

3. Select [MULTI-SCREEN COMP.] → [MODE] → [ON].

4. Adjust the dark part of the images.

Press the ▼ button to select [BRIGHTNESS] and use the ◀ or ▶ to match the black part of another projector.

5. Display the white screen on the computer screen.

Project the image from two or more projectors.

6. Adjust the bright part of the images.

Press the ▼ button to select [CONTRAST] and use the ◀ or ▶ to match the white part of another projector.

Moving the slide bar toward [+] (plus) can change the white part of the image. Should this happen, move the slide bar toward [-] (minus) to adjust the brightness.

TIP:

- When you use multiple projectors, you can use the [CONTROL ID] function to operate a single projector or all the projectors from the remote control. (→ page 126)
- Your setting will not be affected even when [RESET] is done from the menu.

[REF. WHITE BALANCE]

This feature allows you to adjust the white balance for all signals.

The white and black levels of the signal are adjusted for optimum color reproduction.

Uniformity is also adjusted when the redness (R) and blueness (B) of the white color in the screen's horizontal (left/right) direction are uneven.

BRIGHTNESS R/BRIGHTNESS G/BRIGHTNESS B

..... These adjust the picture's black color.

CONTRAST R/CONTRAST G/CONTRAST B

..... These adjust the picture's white color.

UNIFORMITY R..... The further this is set to the + side, the stronger the redness on the left side of the picture (increasing towards the left edge) and the weaker the redness on the right side of the picture (decreasing towards the right edge).

This is reversed when set to the – side.

UNIFORMITY B..... The further this is set to the + side, the stronger the blueness on the left side of the picture (increasing towards the left edge) and the weaker the blueness on the right side of the picture (decreasing towards the right edge).

This is reversed when set to the – side.

Using the Reference Lens Memory Function [REF. LENS MEMORY]

This function serves to store the adjusted values common to all input sources when using the LENS SHIFT, ZOOM and FOCUS buttons of the projector or the remote control. The adjusted values stored in memory can be used as a reference to the current.

STORE Stores the current adjusted values in memory as a reference.

MOVE Applies the adjusted reference values stored in [STORE] to the current signal.

RESET..... Returns the adjusted reference values to the factory default setting.

LOAD BY SIGNAL .. For change to take effect at the time of source selection, select [YES].

FORCED MUTE To turn off the image during lens shift, select [YES].

CALIBRATION Corrects the adjustable zoom and focus range.

The adjustable zoom and focus range can vary depending on the lens in use. Be sure to perform [CALIBRATE] after replacement of the lens.

The following lenses need calibration:

- NP16FL, NP17ZL, NP18ZL, NP19ZL, NP20ZL, NP21ZL, NP31ZL

NOTE: This option is only available when [YES] is selected for [MOVE WITH SIGNAL CHANGE].

NOTE:

- Adjusted values in [REFLENS MEMORY] will not be returned to default when performing [CURRENT SIGNAL] or [ALL DATA] for [RESET] from the menu.
 - To store adjusted values for each input source, use the Lens Memory function. (→ page 47, 116)
-

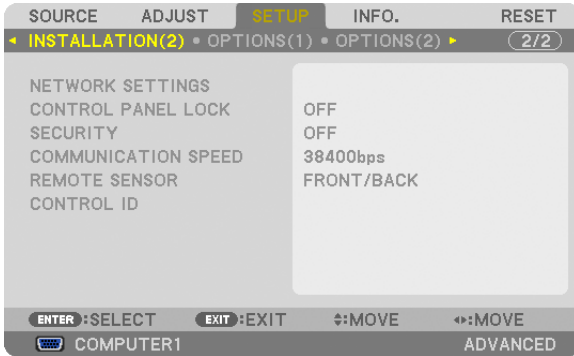
[INSTALLATION(2)]**Disabling the Cabinet Buttons [CONTROL PANEL LOCK]**

This option turns on or off the CONTROL PANEL LOCK function.

NOTE:

- This CONTROL PANEL LOCK does not affect the remote control functions.
- When the control panel is locked, pressing and holding the EXIT button on the projector cabinet for about 10 seconds will change the setting to [OFF].

TIP: When the [CONTROL PANEL LOCK] is turned on, a key lock icon [] will be displayed at the bottom right of the menu.

Enabling Security [SECURITY]

This feature turns on or off the SECURITY function.

Unless the correct keyword is entered, the projector cannot project an image. (→ page 44)

NOTE: Your setting will not be affected even when [RESET] is done from the menu.

Selecting Communication Speed [COMMUNICATION SPEED]

This feature sets the baud rate of the PC Control port (D-Sub 9P). It supports data rates from 4800 to 115200 bps. The default is 38400 bps. Select the appropriate baud rate for your equipment to be connected (depending on the equipment, a lower baud rate may be recommended for long cable runs).

NOTE:

- Select [38400bps] or less when using the User Supportware.
- Your selected communication speed will not be affected even when [RESET] is done from the menu.

Turning On or Off Remote Sensor [REMOTE SENSOR]

This option determines which remote sensor on the projector is enabled in wireless mode.

The options are: FRONT/BACK, FRONT, and BACK.

If the remote control system does not function when direct sunlight or strong illumination strikes the remote control sensor of the projector, change another option.

Setting ID to the Projector [CONTROL ID]

You can operate multiple projectors separately and independently with the single remote control that has the CONTROL ID function. If you assign the same ID to all the projectors, you can conveniently operate all the projectors together using the single remote control. To do so, you have to assign an ID number to each projector.

CONTROL ID NUMBER..... Select a number from 1 to 254 you wish to assign to your projector.

CONTROL ID..... Select [OFF] to turn off the CONTROL ID setting and select [ON] to turn on the CONTROL ID setting.

NOTE:

- When [ON] is selected for [CONTROL ID], the projector cannot be operated by using the remote control that does not support the CONTROL ID function. (In this case the buttons on the projector cabinet can be used.)
- Your setting will not be affected even when [RESET] is done from the menu.
- Pressing and holding the ENTER button on the projector cabinet for 10 seconds will display the menu for canceling the Control ID.

Assigning or Changing the Control ID

1. Turn on the projector.

2. Press the ID SET button on the remote control.

The CONTROL ID screen will be displayed.

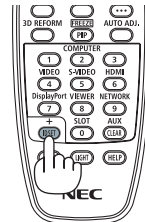

If the projector can be operated with the current remote control ID, the [ACTIVE] will be displayed. If the projector cannot be operated with the current remote control ID, the [INACTIVE] will be displayed. To operate the inactive projector, assign the control ID used for the projector by using the following procedure (Step 3).

3. Press one of numeric keypad buttons while pressing and holding the ID SET button on the remote control.

Example:

To assign “3”, press the “3” button on the remote control.

No ID means that all the projectors can be operated together with a single remote control. To set “No ID”, enter “000” or press the CLEAR button.

TIP: The range of IDs is from 1 to 254.

4. Release the ID SET button.

The updated CONTROL ID screen will be displayed.

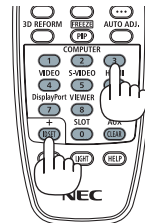

NOTE:

- The IDs can be cleared in a few days after the batteries are run down or removed.
- Accidentally pressing any one of the buttons of the remote control will clear currently specified ID with batteries removed.

[OPTIONS(1)]

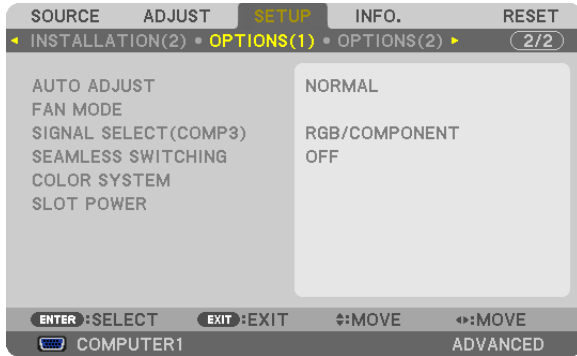

Setting Auto Adjust [AUTO ADJUST]

This feature sets the Auto Adjust mode so that the computer signal can be automatically or manually adjusted for noise and stability. You can automatically make adjustment in two ways: [NORMAL] and [FINE].

- OFF The computer signal will not be automatically adjusted. You can manually optimize the computer signal.
- NORMAL..... Default setting. The computer signal will be automatically adjusted. Normally select this option.
- FINE..... Select this option if fine adjustment is needed. It takes more time to switch to the source than when [NORMAL] is selected.

Selecting Fan Mode [FAN MODE]

Fan Mode is used to set the speed of the internal cooling fan.

- MODE Select three modes for fan speed: AUTO, HIGH, and HIGH ALTITUDE.
 - AUTO: The built-in fans automatically run at a variable speed according to the internal temperature.
 - HIGH: The built-in fans run at high speed
 - HIGH ALTITUDE: The built-in fans run at a high speed. Select this option when using the projector at altitudes approximately 5500 feet/1600 meters or higher.
- SETTING..... Select one of the four options ([FLOOR], [CEILING], [VERTICAL TILT DOWN], or [VERTICAL TILT UP]) according to the installation angle of the projector. See the drawing below.

NOTE: Be sure to select the [SETTING] option according to the projector's orientation. Failure to do so may cause product malfunction.

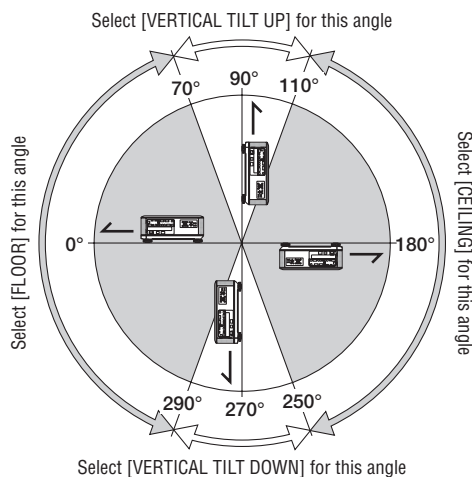

When you wish to cool down the temperature inside the projector quickly, select [HIGH].

NOTE:

- When [HIGH ALTITUDE] is selected for [FAN MODE], a symbol icon  will be displayed at the bottom of the menu.
 - It is recommended that you select High speed mode if you use the projector non-stop for consecutive days.
 - Set [FAN MODE] to [HIGH ALTITUDE] when using the projector at altitudes approximately 5500 feet/1600 meters or higher.
 - Using the projector at altitudes approximately 5500 feet/1600 meters or higher without setting to [HIGH ALTITUDE] can cause the projector to overheat and the projector could shut down. If this happens, wait a couple minutes and turn on the projector.
 - Using the projector at altitudes less than approximately 5500 feet/1600 meters and setting to [HIGH ALTITUDE] can cause the lamp to overcool, causing the image to flicker. Switch [FAN MODE] to [AUTO].
 - Using the projector at altitudes approximately 5500 feet/1600 meters or higher can shorten the life of internal parts such as the lamp.
 - Your setting will not be affected even when [RESET] is done from the menu.
-

Selecting the Signal Format [SIGNAL SELECT(COMP3)]

When an output device is connected to the COMPUTER 3 video input connectors, this sets the input signal.

RGB/COMPONENT. RGB and component signals are identified automatically.

VIDEO This switches to the video signal.

NOTE: When a video cable (commercially available) is connected to the COMPUTER 3 video input connectors' G/Y connector, video signals can be projected. In this case, set to "VIDEO".

[SEAMLESS SWITCHING] (for PX750U2 only)

When the input connector is switched, the image displayed before switching is held to switch to the new image without a break due to absence of a signal.

[COLOR SYSTEM]

This feature allows you to select the TV video signal, which differs from country to country (NTSC, PAL, etc.). This is set to [AUTO] by factory default. Set this if the projector cannot identify the signal automatically.

Setting for the Optional Board [SLOT POWER]

When using the optional board such as SB-01HC installed in the slot, set the following options.

PROJECTOR ON This feature will turn on or off the power to the optional board.

OFF: Forcibly turn off the power to the optional board installed in the slot.

ON (Default): Turn on the power to the optional board installed in the slot.

PROJECTOR STANDBY This feature will automatically enable or disable the optional board installed in the slot when the projector is in standby.

DISABLE: Select this option to disable the optional board in the projector standby.

ENABLE (Default): Select this option to enable the optional board in the projector standby.

NOTE:

- Select [OFF] when the optional board is not installed into the slot.
-

[OPTIONS(2)]

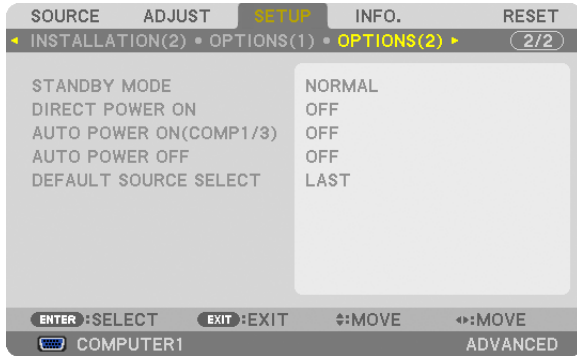

Selecting Power-saving in [STANDBY MODE]

The projector has three standby modes: [NORMAL], [POWER-SAVING] and [NORMAL2]. The POWER-SAVING mode is the mode that allows you to put the projector in the power-saving condition which consumes less power than the NORMAL mode. The projector is preset for POWER-SAVING mode at the factory.

NORMAL..... Power indicator: Orange light/STATUS indicator: Green light
 POWER-SAVING.... Power indicator: Red light/STATUS indicator: Off

The following connectors, buttons or functions will not work during this mode.

- MONITOR OUT (COMP. 1) connector
- LAN and Mail Alert functions
- Buttons other than POWER button on the cabinet
- Buttons other than POWER ON button on the remote control
- Virtual Remote Tool function
- [AUTO POWER ON (COMP1/3)]
- PC control commands for other than power-on

NORMAL2..... When in the standby mode, the POWER indicator will light orange and the STATUS indicator will not light. This shows that the projector's power can be turned on by wired LAN.

When in the standby mode, the following connectors, buttons or functions will not work:

- MONITOR OUT (COMP. 1) connector
- Wireless LAN Unit
- [AUTO POWER ON (COMP1/3)]
- Buttons other than POWER button on the cabinet
- Buttons other than POWER ON button on the remote control
- PC control commands for other than power-on

Important:

- When [CONTROL PANEL LOCK] or [CONTROL ID] is turned on, or when [COMPUTER 1] or [COMPUTER 3] is selected for [AUTO POWER ON (COMP1/3)], the [STANDBY MODE] setting becomes invalid. This means that the projector is in the same condition when the [NORMAL] is selected for [STANDBY MODE].

NOTE:

- Even when [POWER-SAVING] is selected for [STANDBY MODE], power on or off can be done by using the PC CONTROL port.
- The power consumption in the standby mode will not be included in calculating CO₂ emission reduction.
- Your setting will not be affected even when [RESET] is done from the menu.

Enabling Direct Power On [DIRECT POWER ON]

Turns the projector on automatically when the power cord is inserted into an active power outlet. This eliminates the need to always use the POWER button on the remote control or projector cabinet.

Turning On the Projector By Applying Computer Signal [AUTO POWER ON(COMP1/3)]

When the projector is in Standby mode, applying a computer signal from a computer connected to the COMPUTER1 IN or COMPUTER3 IN input will power on the projector and simultaneously project the computer's image. This functionality eliminates the need to always use the POWER button on the remote control or the projector cabinet to power on the projector.

To use this function, first connect a computer to the projector and the projector to an active AC input.

NOTE:

- *Disconnecting a computer signal from the computer will not power off the projector. We recommend using this function in combination of the AUTO POWER OFF function.*
 - *This function will not be available under the following conditions:*
 - *when a component signal is applied to the COMPUTER1 IN or COMPUTER3 IN connector*
 - *when a Sync on Green RGB signal or composite sync signal is applied*
 - *When [AUTO POWER ON(COMP1/3)] is set, the [STANDBY MODE] setting becomes invalid. This means that the projector is in the same condition when the [NORMAL] is selected for [STANDBY MODE].*
 - *To enable the AUTO POWER ON (COMP1/3) after turning off the projector, wait 3 seconds and input a computer signal. If a computer signal is still present when the projector is turned off, the AUTO POWER ON (COMP1/3) will not work and the projector remains in standby mode.*
-

Enabling Power Management [AUTO POWER OFF]

When this option is selected you can enable the projector to automatically turn off (at the selected time: 5min., 10min., 20min., 30min.) if there is no signal received by any input or if no operation is performed.

NOTE:

- *The [AUTO POWER OFF] function will not work when [VIEWER] or [NETWORK] is selected for [SOURCE].*
-

Selecting Default Source [DEFAULT SOURCE SELECT]

You can set the projector to default to any one of its inputs each time the projector is turned on.

- LAST Sets the projector to default to the previous or last active input each time the projector is turned on.
- AUTO Searches for an active source in order of COMPUTER1 → COMPUTER2 → COMPUTER3 → HDMI → DisplayPort → VIDEO → S-VIDEO → VIEWER → COMPUTER1 and displays the first found source.
- COMPUTER1 Displays the computer signal from the COMPUTER 1 IN connector every time the projector is turned on.
- COMPUTER2 Displays the computer signal from the COMPUTER 2 IN connector every time the projector is turned on.
- COMPUTER3 Displays the computer signal from the COMPUTER 3 IN connector every time the projector is turned on.
- HDMI Displays the digital source from the HDMI IN connector every time the projector is turned on.
- DisplayPort Displays the digital source from the DisplayPort every time the projector is turned on.
- VIDEO Displays the Video source from the VIDEO IN connector every time the projector is turned on.
- S-VIDEO Displays the Video source from the S-VIDEO IN connector every time the projector is turned on.
- VIEWER Displays slides or plays back movie files from the USB memory device every time the projector is turned on.
- NETWORK Displays the data sent from the computer via the LAN port (RJ-45) or the wireless LAN unit (sold separately) mounted on the projector is projected.
- SLOT Displays a signal from the optional (SB-01HC or other NEC's optional boards) when it is installed.

[EDGE BLENDING]

This function adjusts overlapping edges of images projected from each projector to uniform multi-screen images.



Turns on or off the Edge Blending function. [MODE]

Turning on [MODE] will make [TOP], [BOTTOM], [LEFT], [RIGHT], and [BLACK LEVEL] available. (Default: OFF).

Selects edge of top, bottom, left, and right of the screen to perform the Edge Blending function. [TOP/BOTTOM/LEFT/RIGHT]

Turning on [CONTROL] will make [MARKER], [RANGE], and [POSITION] available. (→ page 51)

- CONTROL Turns on or off [TOP], [BOTTOM], [LEFT], and [RIGHT].
- MARKER..... Turns on or off a marker for the range and position adjustment. Turning on [MARKER] will display a magenta marker for [RANGE] and green marker for [POSITION].
- RANGE..... Adjusts the Edge Blending range (width).
- POSITION Adjusts the Edge Blending start position.

Adjusts the brightness level of 9-segmented portions. [BLACK LEVEL]

9-segmented portions are [TOP-LEFT], [TOP-CENTER], [TOP-RIGHT], [CENTER-LEFT], [CENTER], [CENTER-RIGHT], [BOTTOM-LEFT], [BOTTOM-CENTER], and [BOTTOM-RIGHT]. (→ page 54)

7 Menu Descriptions & Functions [INFO.]

Displays the status of the current signal and lamp usage. This item has nine pages. The information included is as follows:

TIP: Pressing the HELP button on the remote control will show the [INFO.] menu items.

[USAGE TIME]

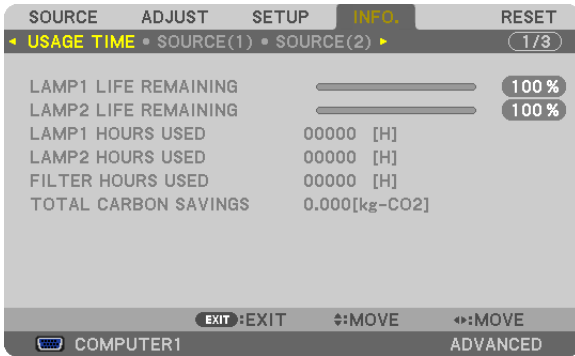

- [LAMP 1 LIFE REMAINING] (%)*
- [LAMP 2 LIFE REMAINING] (%)*
- [LAMP 1 HOURS USED] (H)
- [LAMP 2 HOURS USED] (H)
- [FILTER HOURS USED] (H)
- [TOTAL CARBON SAVINGS] (kg-CO₂)

- * The progress indicator shows the percentage of remaining bulb life.
The value informs you of the amount of lamp usage. When the remaining lamp time reaches 0, the LAMP LIFE REMAINING bar indicator changes from 0% to 100 Hours and starts counting down.
If the remaining lamp time reaches 0 hours, the projector will not turn on.
- The message to the effect that the lamp or the filters should be replaced will be displayed for one minute when the projector is turned on and when the POWER button on the projector or the remote control is pressed.
To dismiss this message, press any button on the projector or the remote control.

Lamp life(H)		Replacement lamp
ECO MODE		
OFF	ON	NP22LP
2000	2500	

- [TOTAL CARBON SAVINGS]
This displays the estimated carbon saving information in kg. The carbon footprint factor in the carbon saving calculation is based on the OECD (2008 Edition). (→ page 38)

[SOURCE(1)]



INPUT TERMINAL
 HORIZONTAL FREQUENCY
 SYNC TYPE
 SCAN TYPE
 ENTRY NO.

RESOLUTION
 VERTICAL FREQUENCY
 SYNC POLARITY
 SOURCE NAME

[SOURCE(2)]



SIGNAL TYPE
 BIT DEPTH
 LINK RATE

VIDEO TYPE
 VIDEO LEVEL
 LINK LANE

[WIRED LAN]



IP ADDRESS
 GATEWAY

SUBNET MASK
 MAC ADDRESS

[WIRELESS LAN(1)]



IP ADDRESS
GATEWAY

SUBNET MASK
MAC ADDRESS

[WIRELESS LAN(2)]



SSID
WEP/WPA
SIGNAL LEVEL

NETWORK TYPE
CHANNEL

[VERSION(1)]



FIRMWARE
FIRMWARE2

DATA

[VERSION(2)]



FIRMWARE3

[OTHERS]

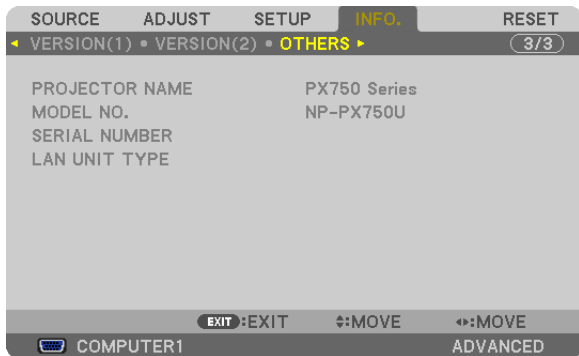

PROJECTOR NAME
 SERIAL NUMBER
 CONTROL ID (when [CONTROL ID] is set)

MODEL NO.
 LAN UNIT TYPE

8 Menu Descriptions & Functions [RESET]



Returning to Factory Default [RESET]

The RESET feature allows you to change adjustments and settings to the factory preset for a (all) source (s) except the following:

[CURRENT SIGNAL]

Resets the adjustments for the current signal to the factory preset levels.

NOTE:

- Locked signals in the Entry List will not be reset.

[ALL DATA]

Reset all the adjustments and settings for all the signals to the factory preset.

All items can be reset **EXCEPT** [ENTRY LIST], [LANGUAGE], [BACKGROUND], [FILTER MESSAGE], [SCREEN], [GEOMETRIC CORRECTION], [MULTI-SCREEN COMP.], [REF.WHITE BALANCE], [CONTROL PANEL LOCK], [SECURITY], [COMMUNICATION SPEED], [CONTROL ID], [SEAMLESS SWITCHING], [STANDBY MODE], [FAN MODE], [EDGE BLENDING], [REF. LENS MEMORY], [DATE AND TIME], [LAMP LIFE REMAINING], [LAMP HOURS USED], [FILTER HOURS USED], [TOTAL CARBON SAVINGS], [WIRED LAN], and [WIRELESS LAN].

To reset the lamp usage time, see “Clearing Lamp Hour Meter [CLEAR LAMP HOURS]” below.

[ALL DATA (INCLUDING ENTRY LIST)]

Reset all the adjustments and settings for all the signals to the factory preset except [LANGUAGE], [BACKGROUND], [FILTER MESSAGE], [SCREEN], [MULTI-SCREEN COMP.], [REF. WHITE BALANCE], [CONTROL PANEL LOCK], [SEAMLESS SWITCHING], [SECURITY], [COMMUNICATION SPEED], [CONTROL ID], [FAN MODE], [EDGE BLENDING], [GEOMETRIC CORRECTION], [REF. LENS MEMORY], [DATE AND TIME], [STANDBY MODE], [LAMP LIFE REMAINING], [LAMP HOURS USED], [FILTER HOURS USED], [TOTAL CARBON SAVINGS], [WIRED LAN], and [WIRELESS LAN].

Also deletes all the signals in the [ENTRY LIST] and returns to the factory preset.

NOTE: Locked signals in Entry List cannot be reset.

Clearing Lamp Hour Meter [CLEAR LAMP 1 HOURS/CLEAR LAMP 2 HOURS]

Resets the lamp clock back to zero. Selecting this option displays submenu for a confirmation. Select [YES] and press the ENTER button.

NOTE: Elapsed time of the lamp use will not be affected even when [RESET] is done from the menu.

NOTE: The projector will turn off and go into standby mode when you continue to use the projector for another 100 hours after the lamp has reached the end of its life. In this condition you cannot clear the lamp hour meter on the menu. If this happens, press the HELP button on the remote control for 10 seconds to reset the lamp clock back to zero. Do this only after replacing the lamp.

Clearing the Filter Usage Hours [CLEAR FILTER HOURS]

Resets the filter usage back to zero. Selecting this option displays submenu for a confirmation. Select [YES] and press the ENTER button.

The [OFF] item is selected for [FILTER MESSAGE] at the time of shipment. When [OFF] is selected, you do not need to clear the filter usage hour.

NOTE: Elapsed time of the filter use will not be affected even when [RESET] is done from the menu.

9 Application Menu

When [NETWORK] is selected from the [SOURCE] menu, the application menu [APPLICATION MENU] will be displayed. The application menu allows you to set up the User Supportware, Network Settings (NETWORK SETTINGS) and Tools (TOOLS).

The User Supportware is contained on the supplied NEC Projector CD-ROM.

In [ADMINISTRATOR MODE], either [ADVANCED] menu or [BASIC] menu can be selected. (→ page 157)

The [BASIC] menu contains minimum essentials of menus and commands.

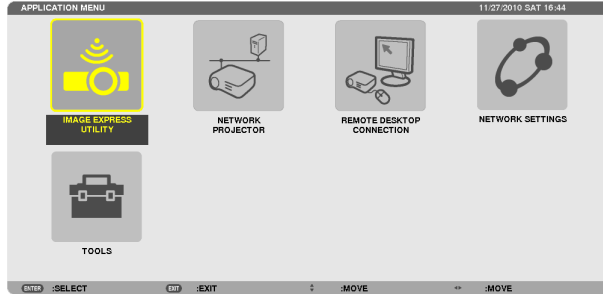
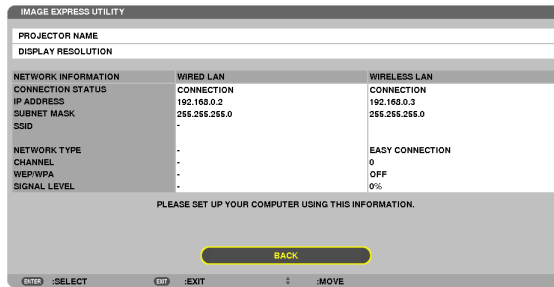

IMAGE EXPRESS UTILITY

This shows information for projector name, resolution, and network (wired/wireless) which are required to use Image Express Utility.

Use this information to set up for your computer.



NETWORK PROJECTOR

This shows information for projector name, resolution, and network (wired/wireless) which are required to use Network Projector.

Use this information to set up for your computer.

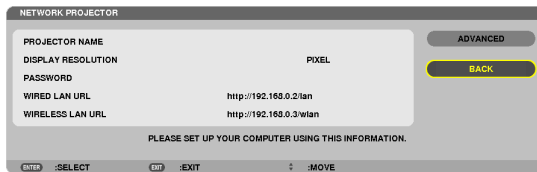

REMOTE DESKTOP CONNECTION

This allows you to set up for computer name entry and effects for Remote Desktop.

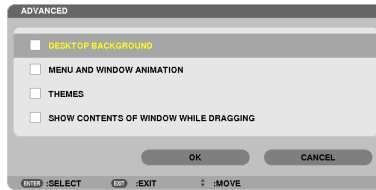
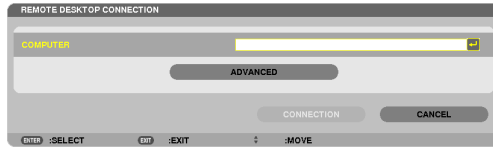

NOTE:

- A USB keyboard is required to set up the Remote Desktop Connection.
-

NETWORK SETTINGS

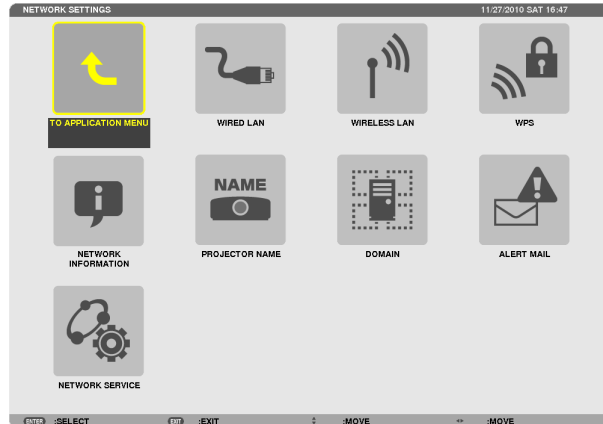

Important:

- Consult with your network administrator about these settings.
- When using a wired LAN connection, connect a LAN cable (Ethernet cable) to the LAN port (RJ-45) of the projector. (→ page 171)

TIP: The network settings you make will not be affected even when [RESET] is done from the menu.

Hints on How to Set Up LAN Connection

To set up the projector for a LAN connection:

Select [WIRED LAN] or [WIRELESS LAN] → [PROFILES] → [PROFILE 1] or [PROFILE 2].

Two settings can be set for wired or wireless LAN.

Next turn on or off for [DHCP], [IP ADDRESS], [SUBNET MASK], and [GATEWAY] and select [OK] and press the ENTER button. (→ page 142)

To recall LAN settings stored in the profile number:

Select [PROFILE 1] or [PROFILE 2] for wired or wireless LAN, and then select [OK] and press the ENTER button. (→ page 142)

To connect a DHCP server:

Turn on [DHCP] for wired or wireless LAN. Select [ON] and press the ENTER button. To specify IP address without using the DHCP server, turn off [DHCP]. (→ page 143)

To set only for wireless LAN (NETWORK TYPE and WEP/WPA):

Select [PROFILE 1] or [PROFILE 2] for wireless LAN, and then select [ADVANCED] and [OK] and press the ENTER button. The Advanced menu will be displayed. (→ page 144)

To select an SSID:

Select [ADVANCED] → [SITE SURVEY] and press the ENTER button.

Select an SSID and press the > button to select [OK] and press the ENTER button.

If you do not use [SITE SURVEY], type the SSID and select [INFRASTRUCTURE] or [AD HOC]. (→ page 144)

To receive lamp replacement time or error messages via e-mail:

Select [ALERT MAIL], and set [SENDER'S ADDRESS], [SMTP SERVER NAME], and [RECIPIENT'S ADDRESS]. Last, select [OK] and press the ENTER button. (→ page 155)

To execute [EASY CONNECTION] using Image Express Utility 2.0 or Image Express Utility 2 for Mac:

The [EASY CONNECTION] is a mode that can abbreviate the troublesome LAN settings when using the Image Express Utility and connecting the PC and projector via a wireless LAN.

Image Express Utility 2.0 and Image Express Utility 2 for Mac are contained on the supplied NEC Projector CD-ROM.

To use [EASY CONNECTION], select [WIRELESS LAN] → [PROFILES] → [EASY CONNECTION].

NOTE: The [EASY CONNECTION] function is available on Windows 7, Windows Vista or Windows XP SP3.

WIRED LAN or WIRELESS LAN (ADVANCED menu only)

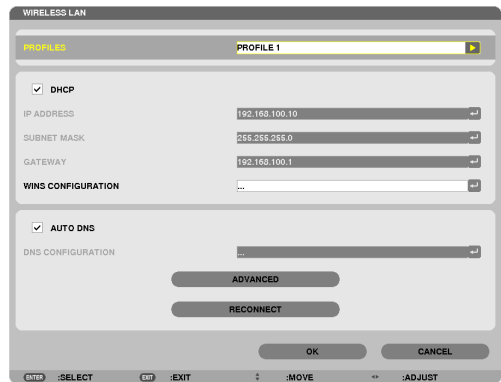
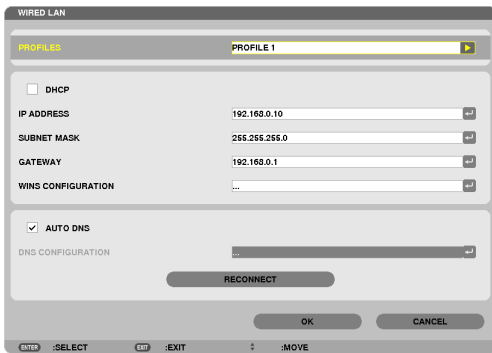

* To use the wireless LAN functions, connect a separately sold wireless LAN unit to the projector. (→ page 172)

<p>PROFILES</p>	<ul style="list-style-type: none"> Up to two settings for the LAN port or USB wireless LAN unit can be stored in memory of the projector. Total of four settings can be stored. Five settings can be stored: two for the built-in LAN port, two for wireless LAN and one for WPS. Select [PROFILE 1] or [PROFILE 2] and then do settings for [DHCP] and the other options. After doing this, select [OK] and press the ENTER button. This will store your settings in memory. To recall the settings from memory: After selecting [PROFILE 1] or [PROFILE 2] from the [PROFILES] list. Select [OK] and press the ENTER button. To stop emitting radio waves from the USB Wireless LAN Unit, select [DISABLE] from the [PROFILES] list. Selecting [SIMPLE ACCESS POINT] will allow the projector to create an infrastructure network. An SSID will be automatically created. When the IP address of the projector is changed, it will automatically take effect in one or two minutes. Select "Obtain an IP Address Automatically" to set the IP address of a connected computer. It takes a few seconds for a change of your computer's IP address to come into effect in Windows 7/Windows Vista while it takes one or two minutes in Window XP. When you connect with your computer to save your profile and select "Automatically connect when within range" from the Properties tab of Wireless Network in Windows for your selected profile, your wireless LAN will be accessed under the following conditions: <ul style="list-style-type: none"> at the time of turning on the computer or the projector when the notebook type is within the range of the projector's wireless LAN can be achieved. <p>Data transmission between wireless LAN and wired LAN is not possible. When the [SIMPLE ACCESS POINT] mode is used to send images, it is recommended to connect to only one computer.</p>	<p>—</p>
-----------------	---	----------

	<ul style="list-style-type: none"> When selecting [WPS], the network will be connected by using settings stored automatically with the WPS function. Selecting [WPS] will allow the projector to access the network by using the settings the WPS function automatically stored. 	
DHCP	Place a check mark to automatically assign an IP address to the projector from your DHCP server. Clear this check box to register the IP address or subnet mask number obtained from your network administrator.	—
IP ADDRESS	Set your IP address of the network connected to the projector when [DHCP] is turned off.	Up to 12 numeric characters
SUBNET MASK	Set your subnet mask number of the network connected to the projector when [DHCP] is turned off.	Up to 12 numeric characters
GATEWAY	Set the default gateway of the network connected to the projector when [DHCP] is turned off.	Up to 12 numeric characters
WNS CONFIGURATION	Set the IP address of your WINS server of the network connected to the projector when [DHCP] is turned off.	Up to 12 numeric characters
AUTO DNS	Place a check mark to automatically assign the IP address of your DNS server connected to the projector from your DHCP server. Clear this check box to set the IP address of your DNS server connected to the projector.	Up to 12 numeric characters
DNS CONFIGURATION	Set the IP address of your DNS server on the network connected to the projector when [AUTO DNS] is cleared.	Up to 12 numeric characters
ADVANCED*	This menu allows you to set various items for your wireless LAN connection (network type, security).	—
RECONNECT	Retry to connect the projector to a network. Try this if you have changed [PROFILES].	—



* The [ADVANCED] setting screen is available for [WIRELESS LAN] only.

NOTE:

- If you select [EASY CONNECTION] from [PROFILES], you cannot make settings to DHCP and its following items except [CHANNEL] in [ADVANCED].

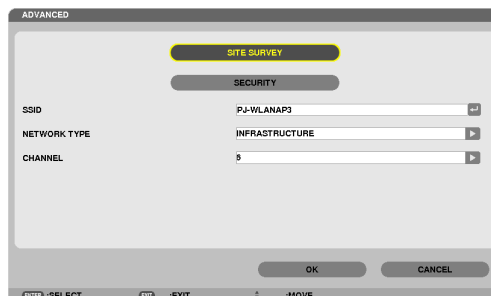
Advanced Settings (settings only required when using a separately sold wireless LAN unit) (ADVANCED menu only)



SITE SURVEY	<p>Displays a list of available SSIDs for wireless LAN on site. Select an SSID which you can access. To select an SSID, highlight [SSID] and use the ► to select [OK] and press the ENTER button.</p> <p>  Wireless access point  Ad Hoc PC  WEP or WPA enabled </p>	—
SECURITY	<p>This will turn on or off the encryption mode for secure transmission. To use encryption, specify a WEP key or encryption key. Select your security type appropriate for your computer and the wireless LAN unit.</p> <p> DISABLE Will not turn on the encryption feature. Your communications may be monitored by someone. WEP(64bit) Uses 64-bit datalength for secure transmission. WEP(128bit) Uses 128-bit datalength for secure transmission. This option will increase privacy and security when compared to use of 64-bit datalength encryption. WPA-PSK/WPA2-PSK/WPA-EAP/WPA2-EAP These options provide stronger security than WEP. </p> <hr/> <p><i>NOTE:</i></p> <ul style="list-style-type: none"> • The security type, WEP key, and encryption key settings must be the same as communication devices such as PC or access point in your wireless network. • When you use [SECURITY], your image transmission speed will slow down. • [WPA-PSK], [WPA-EAP], [WPA2-PSK] and [WPA2-EAP] are not available when [AD HOC] is selected from [NETWORK TYPE]. 	—
SSID	<p>Enter an identifier (SSID) for wireless LAN. Communication can be done only with equipment whose SSID matches SSID for your wireless LAN.</p>	Up to 32 alphanumeric characters (case sensitive).
NETWORK TYPE	<p>Select communication method when using wireless LAN.</p> <p> INFRASTRUCTURE... Select this option when communicating with one or more equipment connected to the wireless or wired LAN network via a wireless access point. AD HOC Select this option when using the wireless LAN to directly communicate with a computer in peer-to-peer mode. </p>	—
CHANNEL	<p>Select a channel. Available channels vary depending on the country and region. When you select [INFRASTRUCTURE], make sure that the projector and your access point are on the same channel; when you select [AD HOC], make sure that the projector and your computer are on the same channel.</p>	—

When [WEP(64bit)] or [WEP(128bit)] is selected for [SECURITY TYPE]

KEY SELECT	Selects one WEP key from the four keys below.		
KEY1, KEY2, KEY3, KEY4	Enter a WEP key.		
	• Maximum number of characters		
	Option	Alphanumeric (ASCII)	Hexadecimal (HEX)
	WEP 64bit	5	10
WEP 128bit	13	26	

When [WPA-PSK], [WPA-EAP], [WPA2-PSK], or [WPA2-EAP] is selected for [SECURITY TYPE]

ENCRYPTION TYPE	Select [TKIP] or [AES].
KEY	Enter encryption key. Key length must be 8 or greater and 63 or less.

[AUTHENTICATION] (required for wireless only)

Setting is required for using WPA-EAP or WPA2-EAP.

Preparation before setting

Select a wireless LAN compliant WPA-EAP or WPA2-EAP authentication and install a digital certificate on the projector.

1. Set [DATE AND TIME] on the projector. (→ page 161)
2. Use a computer to save digital certificates (files) for WPA-EAP or WPA2-EAP setting to your USB memory device.

After completing saving the file, remove the USB memory device from the computer.

Important:

- The file formats of digital certificate that are supported by the projector are DER and PKCS#12 only.
- The projector cannot handle any digital certificate whose file size exceeds 8 KB.
- CRL (Certificate Relocation List) is not supported.
- Client certificate chain is not supported.

3. Plug the USB memory device into the USB port of the projector.

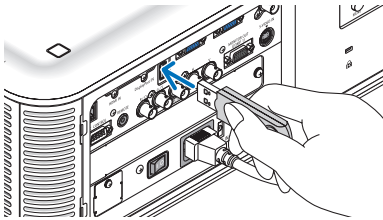

Setting Procedures

1. Select [NETWORK SETTINGS] → [WIRELESS LAN].

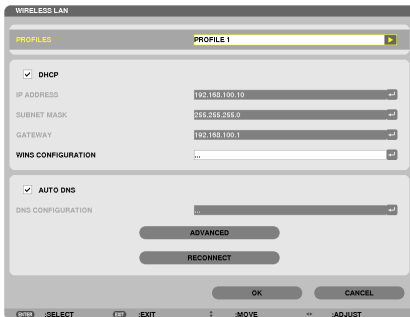

2. Set items such as PROFILES, DHCP, IP ADDRESS, SUBNET MASK and others as required.
 - Select [PROFILE 1] or [PROFILE 2] for [PROFILES]. If [EASY CONNECTION] is selected, WPA-PSK, WPA2-PSK, WPA-EAP, or WPA2-EAP is not available.
3. Select [ADVANCED] and press the ENTER button.

The [ADVANCED] setting screen will be displayed.

4. Select [SITE SURVEY] and press the ENTER button.

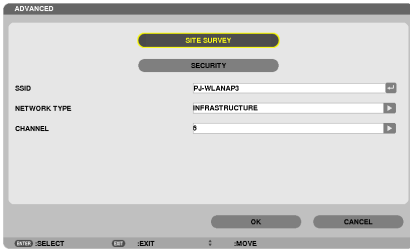

The "SSID" list will be displayed.

5. Select a connecting SSID, and then select [OK].

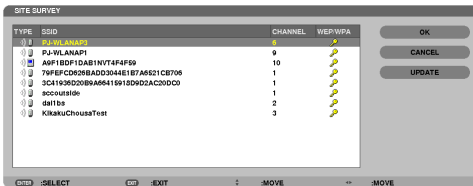

Finally press the ENTER button.

- Select the SSID for which WPA-PSK or WPA2-PSK is set.
- Select [INFRASTRUCTURE (📶)] for [NETWORK TYPE]. WPA-PSK, WPA2-PSK, WPA-EAP, or WPA2-EAP is not available when [AD HOC (📶)] is selected.

6. Select the [SECURITY] tab.

The [SECURITY] page will be displayed.

7. Select the [SECURITY TYPE] field and press the ENTER button.

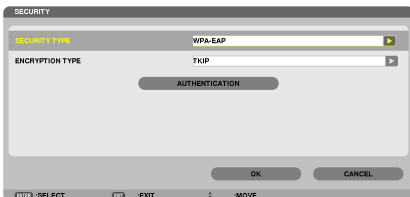

The pull-down list will be displayed.

8. Select [WPA-EAP] or [WPA2-EAP] and press the ENTER button.

9. Select the [TKIP/AES] field and press the ENTER button.

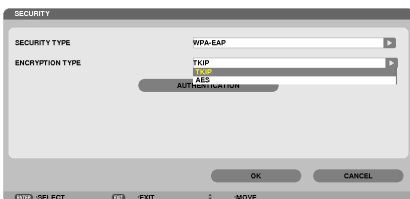

The pull-down list will be displayed.

10. Select [TKIP] or [AES] and press the ENTER button.

Select [TKIP] or [AES] according to the setting for your access point.

11. Select the [AUTHENTICATION] tab.

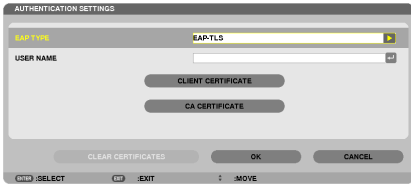

The [AUTHENTICATION] page will be displayed.

Select either [EAP-TLS] or [PEAP-MSCHAPv2] for [EAP TYPE]. The setting items vary depending on the EAP type. See the table below.

EAP Type	Setting Item	Note
EAP-TLS	User Name	1 character or more and 32 characters or less
	Client Certificate	PKCS#12 format file
	CA Certificate (Certificate authority's certificate)	DER format file
PEAP-MSCHAPv2	User Name	1 character or more and 32 characters or less
	Password	1 character or more and 32 characters or less
	CA Certificate (Certificate authority's certificate)	DER format file

① Selecting [EAP-TLS] for [EAP TYPE]:

The following section explains the operation for selecting [EAP-TLS].

For selecting [PEAP-MSCHAPv2], go on to Step 12 on page 150.

12. Select the [USER NAME] field and press the ENTER button.

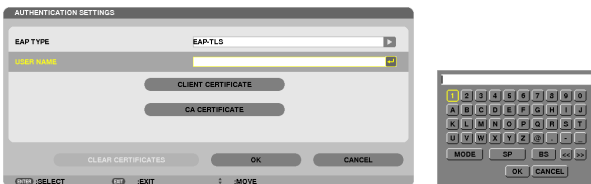

The character entry screen (software keyboard) will be displayed. Set a user name.

- A user name must be 1 character or more and 32 characters or less.
(→ page 152)

13. Select [CLIENT CERTIFICATE] and press the ENTER button.



A list of files (thumbnail screen) will be displayed.

- For operating the thumbnail screen, see “4. Using the Viewer” in the “User’s Manual” (PDF).
- To return to the [AUTHENTICATION] page, press the EXIT button.

NOTE:

Installing a digital certificate

You can install each digital certificate (client certificate and CA certificate) for [PROFILE 1 (or 2)] on a file-by-file basis.

- Install a root CA certificate for a CA certificate.
- If you install a digital certificate over your existing digital certificate, the existing digital certificate will be overwritten with the new digital certificate.
- Once a digital certificate has been installed, its information cannot be deleted even if you stop setting WPA-EAP or WPA2-EAP.

14. On the thumbnail screen, select a digital certificate (PKCS#12 format file) saved in your USB memory device and press the ENTER button.

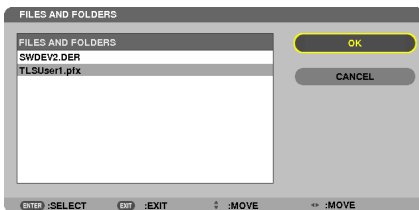

The password screen will be displayed.

15. Select [PASSWORD] field and press the ENTER button.

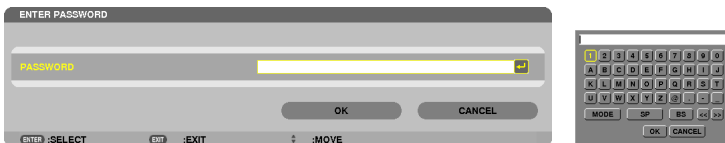

The character entry screen (software keyboard) will be displayed. Set the password of the private key. A password must be 1 character or more and 32 characters or less.

The selected digital certificate file will be installed on the projector.

- When the root CA certificate is not included in the file that was selected in Step 14, proceed to Step 16. When the root certification authority certificate is included, proceed to Step 18.

16. Select [CA CERTIFICATE] and press the ENTER button.

The drive list screen will be displayed.

17. On the thumbnail screen, select a digital certificate (DER format file) saved in your USB memory device and press the ENTER button.

- Select your root CA certificate here.

The selected digital certificate will be installed on the projector.

18. After completing required settings, select [OK] and press the ENTER button.

The [WIRELESS] page will be returned.

19. Select [RECONNECT] and press the ENTER button.

20. Select [OK] and press the ENTER button.

This will complete setting [EAP-TLS] for [EAP TYPE] in [WPA-EAP] or [WPA2-EAP].

TIP:

Clearing the digital certificate that is installed on the projector

To clear the digital certificate installed on the projector, follow the steps below.

By doing the following procedure, all the digital certificates for the currently displayed profile will be cleared.

1. Select [CLEAR CERTIFICATES] in the bottom left of the [ADVANCED] setting screen and press the ENTER button.

A message for confirmation will be displayed.

2. Select [YES] and press the ENTER button.

The digital certificates will be cleared.



TIP:

- The PKCS#12 format digital certificate including a CA certificate will be installed as a root CA certificate.

② Selecting [PEAP-MSCHAPv2] for [EAP TYPE]:

12. From the [AUTHENTICATION] page, select [EAP TYPE] field and press the ENTER button.



The pull-down list will be displayed.

13. Select [PEAP-MSCHAPv2] and press the ENTER button.

14. Select [USER NAME] field and press the ENTER button.

The character entry screen (software keyboard) will be displayed. Set a user name.

- A user name must be 32 characters or less.

(→ page 152)

15. After completing setting a user name, select the [PASSWORD] field and press the ENTER button.



The character entry screen (software keyboard) will be displayed. Set a password.

- A password must be 32 characters or less.

16. After completing setting the password, select [CA CERTIFICATE] field and press the ENTER button.

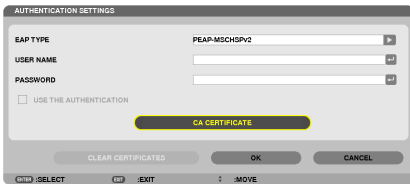

The drive list screen will be displayed.

- For operating the thumbnail screen, see “4. Using the Viewer” in the “User’s Manual” (PDF).
- To return to the [AUTHENTICATION] page, press the EXIT button.

NOTE:

Installing a digital certificate

You can install each digital certificate (client certificate and CA certificate) for [PROFILE 1 (or 2)] on a file-by-file basis.

- Install a root CA certificate for a CA certificate.
- If you install a digital certificate over your existing digital certificate, the existing digital certificate will be overwritten with the new digital certificate.
- Once a digital certificate has been installed, its information cannot be deleted even if you stop setting WPA-EAP or WPA2-EAP.

17. On the thumbnail screen, select a digital certificate (DER format file) saved in your USB memory device and press the ENTER button.

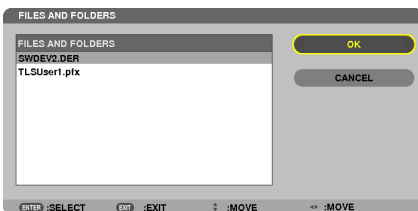

- Select your root CA certificate here.

The selected digital certificate will be installed on the projector.

18. After completing required settings, select [OK] and press the ENTER button.

The [WIRELESS] page will be returned.

19. Select [RECONNECT] and press the ENTER button.

20. Select [OK] and press the ENTER button.

This will complete setting [PEAP-MSCHAPv2] for [EAP TYPE] in [WPA-EAP] or [WPA2-EAP].

TIP:

Clearing the digital certificate that is installed on the projector

To clear the digital certificate installed on the projector, follow the steps below.

By doing the following procedure, all the digital certificates for the currently displayed profile will be cleared.

1. Select [CLEAR CERTIFICATES] in the bottom left of the [ADVANCED] setting screen and press the ENTER button.

A message for confirmation will be displayed.

2. Select [YES] and press the ENTER button.

The digital certificates will be cleared.

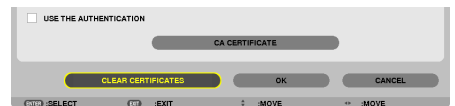

TIP:

Entering WEP keys (Switching between Alphanumeric characters and hexadecimal)

To enter from [KEY1] to [KEY4], do the following:

1. Select one of [KEY 1], [KEY 2], [KEY 3] and [KEY 4] and press the ENTER button.

The character entry screen (software keyboard) will be displayed.

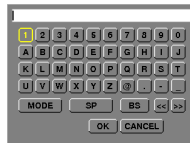

2. Use the ▼, ▲, ◀, or ▶ button to select a character and press the ENTER button.

- To enter a WEP key or passphrase, use alphanumeric characters (ASCII) or hexadecimal (HEX). To enter a PSK key, use alphanumeric characters (ASCII).
- Press the [HEX] button to change to [ASCII] to set the key in ASCII digit. You can toggle this button between [ASCII] and [HEX].
- Enter 0x(numeral and alphabet respectively) right in front of your key code.
- Hexadecimal uses 0 to 9 and A to F.

3. After entering your WEP key or passphrase, use the ▼, ▲, ◀, or ▶ button to select [OK] and press the ENTER button.

The character entry screen (software keyboard) will be closed.

WPS

When the wireless LAN access point connected to the projector supports WPS (Wi-Fi Protected Setup™), you can use PIN method or push button method to set up the wireless LAN for the projector.

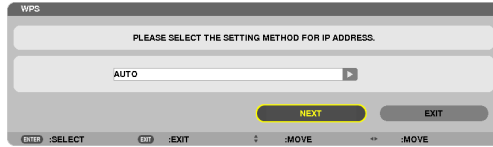

PIN TYPE	Set a 4-digit or 8 digit-PIN code of WPS for your access point to complete setting for the SSID security.
PUSH BUTTON TYPE	Press the dedicated button of the access point and the projector's wireless LAN unit to complete setting for the SSID security.

NETWORK INFORMATION

The following information will be displayed when the projector is connected to a network (wired LAN or wireless LAN).

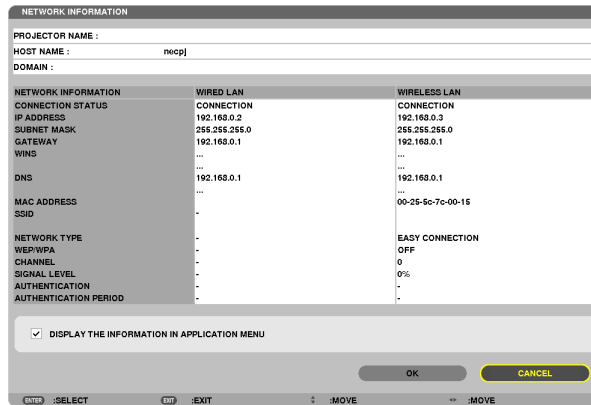

PROJECTOR NAME	
HOST NAME	
DOMAIN	
NETWORK INFORMATION (WIRED LAN/WIRELESS LAN)	CONNECTION STATUS, IP ADDRESS, SUBNET MASK, GATEWAY, WINS, DNS, MAC ADDRESS, SSID, NETWORK TYPE, WEP/WPA, CHANNEL, SIGNAL LEVEL, AUTHENTICATION, AUTHENTICATION PERIOD
DISPLAY THE INFORMATION IN APPLICATION MENU	Turn on or off the display of the network information.

The meanings of these status statements are described below.

Statement	Authentication status
Authenticated	Authentication is done correctly.
Failure	Authentication failed.
Authenticating...	Authentication is in process.
Expired	The digital certificate is expired. Or [DATE, TIME PRESET] is not set correctly.
Time Error	The [DATE, TIME PRESET] has been cleared. Set the correct date and time.

PROJECTOR NAME (ADVANCED menu only)



PROJECTOR NAME	Set a unique projector name.	Up to 16 alphanumeric characters and symbols
----------------	------------------------------	--

DOMAIN (ADVANCED menu only)

Set a host name and domain name of the projector.

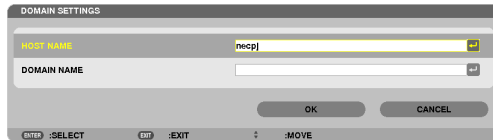

HOST NAME	Set a host name of the projector.	Up to 15 alphanumeric characters
DOMAIN NAME	Set a domain name of the projector.	Up to 60 alphanumeric characters

ALERT MAIL (ADVANCED menu only)

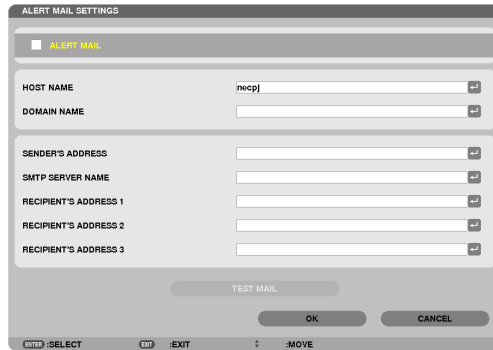

ALERT MAIL	<p>This option will notify your computer of lamp replace time or error messages via e-mail when using wireless or wired LAN. Placing a checkmark will turn on the Alert Mail feature. Clearing a checkmark will turn off the Alert Mail feature.</p> <p>Sample of a message to be sent from the projector:</p> <div style="border: 1px solid black; padding: 5px;"> <p>The lamp and filters are at the end of its usable life. Please replace the lamp and filters. Projector Name: NEC Projector Lamp 1 Hours Used: xxxx [H] Lamp 2 Hours Used: xxxx [H]</p> </div>	—
HOST NAME	Type in a host name.	Up to 15 alphanumeric characters
DOMAIN NAME	Type in a domain name of the network connected to the projector.	Up to 60 alphanumeric characters
SENDER'S ADDRESS	Specify the sender's address.	Up to 60 alphanumeric characters and symbols
SMTP SERVER NAME	Type in the SMTP server name to be connected to the projector.	Up to 60 alphanumeric characters
RECIPIENT'S ADDRESS 1, 2, 3	Type in your recipient's address.	Up to 60 alphanumeric characters and symbols
TEST MAIL	<p>Send a test mail to check if your settings are correct.</p> <p><i>NOTE:</i></p> <ul style="list-style-type: none"> • If you entered an incorrect address in a test, you may not receive an Alert mail. Should this happen, check if the Recipient's Address is correctly set. • Unless any one of the [SENDER'S ADDRESS], [SMTP SERVER'S NAME] or [RECIPIENT'S ADDRESS 1-3] is selected, [TEST MAIL] is not available. • Be sure to highlight [OK] and press the ENTER button before executing [TEST MAIL]. 	—

NETWORK SERVICE (ADVANCED menu only)

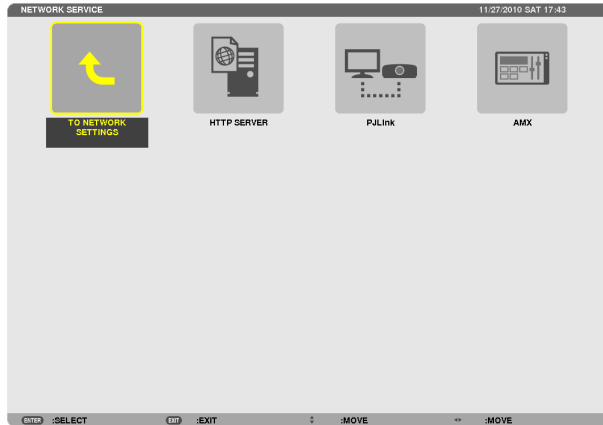

HTTP SERVER	Set a password for your HTTP server.	Up to 10 alphanumeric characters
PJLink	<p>This option allows you to set a password when you use the PJLink feature.</p> <hr/> <p><i>NOTE:</i></p> <ul style="list-style-type: none"> • Do not forget your password. However, if you forget your password, consult with your dealer. • What is PJLink? PJLink is a standardization of protocol used for controlling projectors of different manufacturers. This standard protocol is established by Japan Business Machine and Information System Industries Association (JBMIA) in 2005. The projector supports all the commands of PJLink Class 1. • Setting of PJLink will not be affected even when [RESET] is done from the menu. 	Up to 32 alphanumeric characters
AMX	<p>Turn on or off for detection from AMX Device Discovery when connecting to the network supported by AMX's NetLinx control system.</p> <p><i>TIP:</i> When using a device that supports AMX Device Discovery, all AMX NetLinx control system will recognize the device and download the appropriate Device Discovery Module from an AMX server.</p> <p>Placing a checkmark will enable detecting the projector from AMX Device Discovery. Clearing a checkmark will disable detecting the projector from AMX Device Discovery.</p>	—

TOOLS

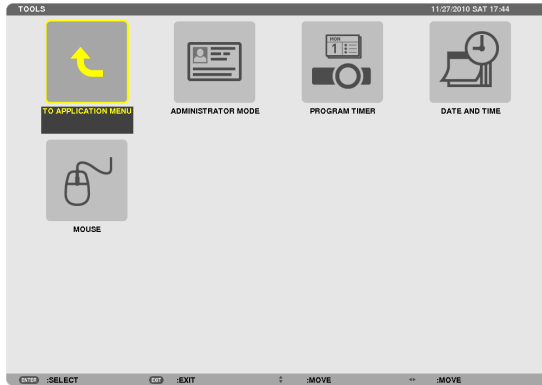

ADMINISTRATOR MODE

This allows you to select MENU MODE, save settings, and set a password for the administrator mode.

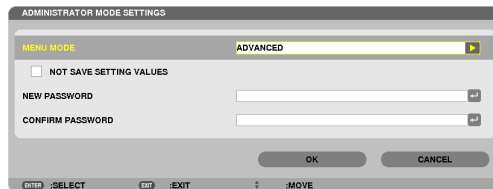

MENU MODE	Select either [BASIC] or [ADVANCED] menu. (→ page 101)	—
NOT SAVE SETTING VALUES	Placing a check mark will not save your projector settings. Clear this check box to save your projector settings.	—
NEW PASSWORD/ CONFIRM PASS- WORD	Assign a password for the administrator mode.	Up to 10 alphanumeric characters

NOTE:

When [LAST] is selected for [DEFAULT SOURCE SELECT], placing a check mark for [NOT SAVE SETTING VALUES] will forcibly select NETWORK for source at every power-on time.

To avoid this, select [AUTO] for [DEFAULT SOURCE SELECT] before placing a check mark for [NOT SAVE SETTING VALUES].

TIP:

To return to the ADVANCED menu from the BASIC menu, do the following:

1. Use the **SOURCE** button on the cabinet or press the **NETWORK** button on the remote control to select [NETWORK] to display the **APPLICATION MENU**.
2. Select [TOOLS] → [ADMINISTRATOR MODE] → [MENU MODE] → [ADVANCED MODE].

PROGRAM TIMER

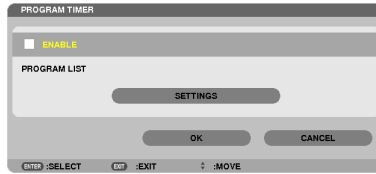

This option turns on/off the projector and changes video signals, and selects ECO mode automatically at a specified time.

NOTE:

- Before using [PROGRAM TIMER], make sure that the [DATE AND TIME] feature is set. (→ page 161)
- Make sure that the projector is in the stand by condition with the POWER cord connected.
- The projector has a built-in clock. The clock will keep working for about two weeks after the main power is turned off. If the main power is not supplied to the projector for two weeks or more, the built-in clock stops working.
- When [PROGRAM TIMER] is enabled, the [STANDBY MODE] setting becomes invalid. This means that the projector is in the same condition when the [NORMAL] is selected for [STANDBY MODE].

Setting a new program timer

1. On the PROGRAM TIMER screen, use the ▲ or ▼ button to select [SETTINGS] and press the ENTER button.



The [PROGRAM LIST] screen will be displayed.

2. Select a blank program number and press the ENTER button.

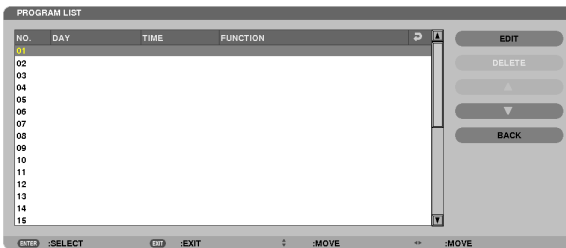

The [EDIT] screen will be displayed.

3. Make settings for each item as required.

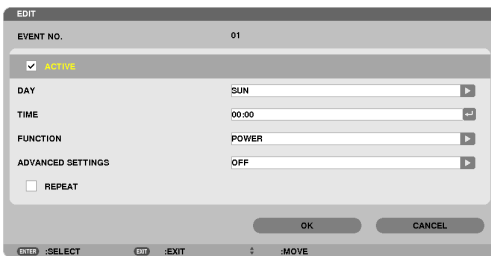

- ACTIVE Place a check mark to enable the program.
- DAY..... Select days of the week for the program timer. To execute the program from Monday to Friday, select [MON-FRI]. To execute the program in everyday basis, select [EVERYDAY].
- TIME..... Set the time to execute the program. Enter time in 24-hour format.
- FUNCTION Select a function to be executed. Selecting [POWER] will allow you to turn on or off the projector by setting

[ADVANCED SETTINGS]. Selecting [SOURCE] will allow you to select a video source by setting [ADVANCED SETTINGS]. Selecting [ECO MODE] will allow you to select [ECO MODE] by setting [ADVANCED SETTINGS].

ADVANCED SETTINGS

..... Select power on/off, a type of video source, or ECO MODE for the selected item in [FUNCTION].

REPEAT..... Place a check mark to repeat the program continuing basis. To use the program this week only, clear the check mark.

4. Select [OK] and press the ENTER button.

This will complete the settings.

You will be returned to the [PROGRAM LIST] screen.

5. Select [BACK] and press the ENTER button.

You will be returned to the [PROGRAM TIMER] screen.

6. Select [OK] and press the ENTER button.

You will be returned to the [TOOLS] screen.

NOTE:

- *Up to 30 different timer settings can be programmed.*
 - *When [PROGRAM TIMER] is turned on, the [STANDBY MODE] setting is ignored.*
 - *The Program Timer is executed on a set time basis, not in a program basis.*
 - *Once the program not marked with a check in [REPEAT] has been executed, the check mark in the [ACTIVE] check box will be cleared automatically and the program will be disabled.*
 - *When the on-time and the off-time set for the same time, the off-time setting will take preference.*
 - *Two different sources are set for the same time, the larger program number will take preference.*
 - *The on-time setting will not be executed while the cooling fans are running or an error is occurring.*
 - *If the off-time setting is expired under the condition in which the power off is not possible, the off-timer setting will not be executed until the power off becomes possible.*
 - *Programs not marked with a check mark in [ACTIVE] of the [EDIT] screen will not be executed even if the Program Timer is enabled.*
 - *When the projector is turned on by using the program timer and if you want to turn off the projector, set the off-time or do it manually so as not to leave the projector on for a long period of time.*
-

Activating the program timer

1. Select **[ENABLE]** on the **[PROGRAM TIMER]** screen and press the **ENTER** button.

The [ENABLE] will be activated.

2. Select **[OK]** and press the **ENTER** button.

The [PROGRAM TIMER] screen will be changed to the [TOOL] screen.

NOTE:

- Clearing **[ENABLE]** will disable the Program Timer even when a program is marked with a check mark on **[PROGRAM LIST]** screen.
 - When **[ENABLE]** is selected, the **[PROGRAM LIST]** cannot be edited. To edit the programs, select **[ENABLE]** to turn off the Program Timer.
-

Changing the programmed settings

1. On the **[PROGRAM LIST]** screen, select a program you want to edit and press the **ENTER** button.

2. Change the settings on the **[EDIT]** screen.

3. Select **[OK]** and press the **ENTER** button.

The programmed settings will be changed.

You will be returned to the [PROGRAM LIST] screen.

Changing the order of programs

1. On the **[PROGRAM LIST]** screen, select a program whose order you want to change and press the **►** button.

2. Press the **▼** button to select **▲** or **▼**.

3. Press the **ENTER** button a few times to select a row to which you wish to move the program.

The order of the programs will be changed.

Deleting the programs

1. On the **[PROGRAM LIST]** screen, select a program number you want to delete and press the **►** button.

2. Press the **▼** button to select **[DELETE]**.

3. Press the **ENTER** button.

The confirmation screen will be displayed.

4. Select **[YES]** and press the **ENTER** button.

The program will be deleted.

This will complete deleting the program.

DATE AND TIME

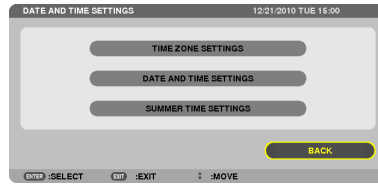

You can set the current time, month, date, and year.

NOTE: The projector has a built-in clock. The clock will keep working for about 2 weeks after the main power is turned off. If the main power is off for 2 weeks or more, the built-in clock will cease. If the built-in clock ceases, set the date and time again. The built-in clock will not cease while in the standby mode.

TIME ZONE SETTINGS..... Select your time zone.

DATE AND TIME SETTINGS Set your current date (MM/DD/YYYY) and time (HH:MM).

INTERNET TIME SERVER If you place a check mark, the projector's built-in clock will be synchronized with an Internet time server in every 24 hours and at the time of projector's startup.

UPDATE Synchronizes the projector's built-in clock immediately. The UPDATE button is not available unless the INTERNET TIME SERVER check box is turned on.

SUMMER TIME SETTINGS If you place a check mark, the clock for daylight saving will be enabled.

MOUSE

This option lets you to change your USB mouse settings. The mouse settings feature is available for USB mouse only. Choose the settings you want:

MOUSE BUTTON [RIGHT HAND] or [LEFT HAND]

MOUSE SENSITIVITY [FAST], [MEDIUM] or [SLOW]

6. Connecting to Other Equipment

① Mounting a lens (sold separately)

Optional bayonet style lenses can be used with this projector. The descriptions here are for the NP18ZL (1.3x zoom) lens on the PX750U2. Mount other lenses in the same manner.

Important:

- Be sure to perform [CALIBRATE] after replacement of the lens. (→ page 125)

NOTE:

- The projector and lenses are made of precision parts. Do not subject them to shock or excessive forces.
- Remove the separately sold lens when moving the projector. If not, the lens could be subject to shock while the projector is being moved, damaging the lens and the lens shift mechanism.
- Turn off the power and wait for the cooling fan to stop and turn off the main power switch before mounting or removing the lens.
- When dismantling the lens from the projector, return the lens position to the home position before turning off the power. Failure to do so may prevent the lens from being mounted or dismantled because of narrow space between the projector and the lens.
- Never touch the lens surface while the projector is operating.
- Be very careful not to let dirt, grease, etc., on the lens surface and not to scratch the lens surface.
- Perform these operations on a flat surface over a piece of cloth, etc., to prevent the lens from getting scratched.
- When leaving the lens off the projector for long periods of time, mount the dust cap on the projector to prevent dust or dirt from getting inside.
- If you have multiple projectors, be careful of the following:
The following lenses designed exclusively for this projector cannot be mounted onto another projector.
 - PX750U2: NP16FL/NP17ZL/NP18ZL/NP19ZL/NP20ZL/NP21ZL/NP31ZL
 - PX700W2/PX800X2: NP06FL/NP07ZL/NP08ZL/NP09ZL/NP10ZL/NP31ZL

Mounting the lens

1. Remove the dust cap from the projector.

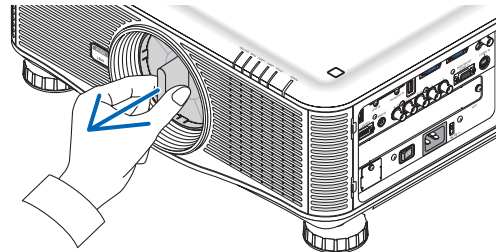

2. Remove the lens cap on the back of the lens.

- The lens NP18ZL is used as an example.

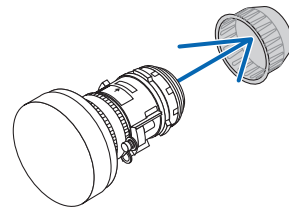

3. While pressing the LENS button on the projector's front panel fully in, insert the lens onto the projector with the arrow mark in the label on the lens facing upwards.

Insert the lens slowly all the way in, keeping the positioning slit at the same angle.

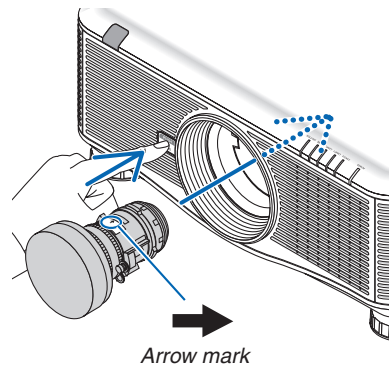

6. Installation and Connections

4. Release the LENS button and then, turn.

Turn until a click is heard.

The lens is now fastened onto the projector.

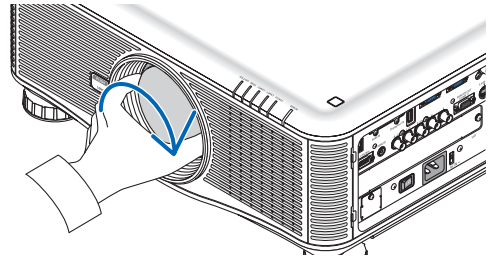

TIP: Mounting the lens theft prevention screw

Fasten the lens theft prevention screw included with the projector to the bottom of the projector so that the lens cannot be removed easily.

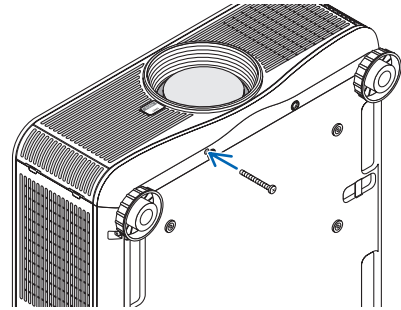

Removing the lens

Before removing the lens:

1. Turn on the projector and display an image. (→ page 17)
2. Press and hold the SHUTTER/HOME POSITION button for 2 seconds.
The lens position will be moved to the home position.
3. Turn off the projector, turn off the main power switch, and then unplug the power cord.
4. Wait until the projector cabinet is cool enough to handle.

1. While pressing the LENS button on the projector's front panel fully in, turn the lens counterclockwise.

The lens comes off.

NOTE: If the lens cannot be removed when the LENS button is pressed, check whether the lens theft prevention screw is mounted.

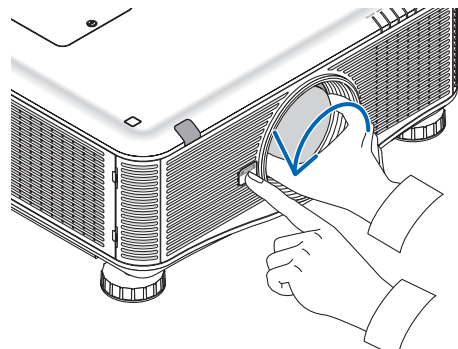

2. After slowly pulling the lens off the projector, release the LENS button.

- After removing the lens, mount the lens caps (front and back) included with the lens before storing the lens.
- If no lens is going to be mounted on the projector, mount the dust cap included with the projector.

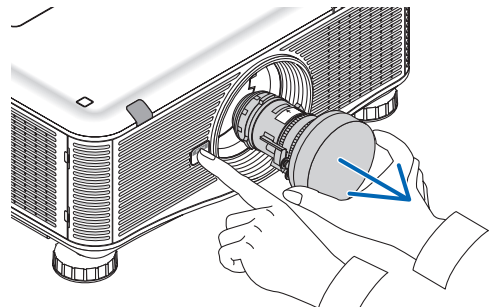

② Making Connections

The projector can be connected to a computer using the computer cable, a 5 x BNC cable, HDMI cable or DisplayPort cable.

Prepare commercially available cables for connection.

Analog RGB signal connection

- Connect the computer cable between the computer's display output connector (mini D-Sub 15-pin) and the projector's Computer 1 or Computer 2 video input connector.
- When connecting the computer's display output connector (mini D-Sub 15-pin) and the projector's Computer 3 video input connector, use a BNC cable (5-core) → mini D-Sub 15-pin converter cable.
- To output audio from the computer, use commercially available audio system.

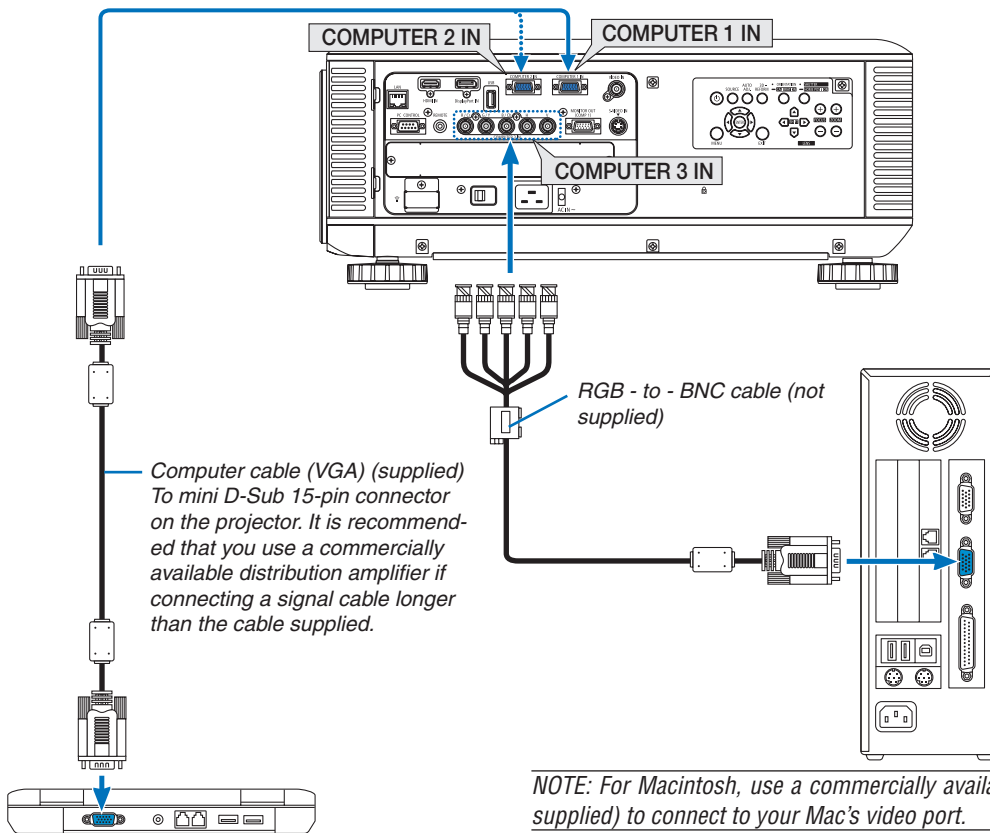

- Select the source name for its appropriate input connector after turning on the projector.



Input connector	SOURCE button on the projector cabinet	Button on the remote control
COMPUTER 1 IN	COMPUTER 1	COMPUTER 1
COMPUTER 2 IN	COMPUTER 2	COMPUTER 2
COMPUTER 3 IN	COMPUTER 3	COMPUTER 3

Digital RGB signal connection

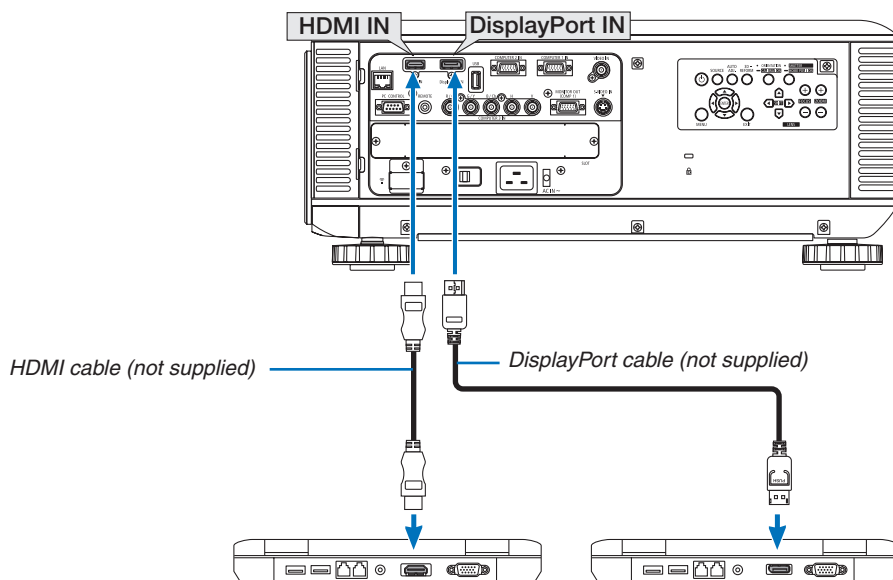
- Connect a commercially available HDMI cable between the computer's HDMI output connector and the projector's HDMI input connector.
- Connect a commercially available DisplayPort cable between the computer's DisplayPort output connector and the projector's DisplayPort input connector.



- Select the source name for its appropriate input connector after turning on the projector.

Input connector	SOURCE button on the projector cabinet	Button on the remote control
HDMI IN	 HDMI	HDMI
DisplayPort IN	 DisplayPort	DisplayPort

NOTE:

- Turn off the power of the computer and projector before connecting.
- This projector does not support NEC video unit (model ISS-6020) video decoded outputs.
- When a video deck is connected via a scan converter, etc., the display may not be correct during fast-forwarding and rewinding.

TIP

- The Computer 1 and Computer 2 video input connectors support Windows Plug and Play. The Computer 3 video input connector does not support Windows Plug and Play.
- A Macintosh signal adapter (commercially available) may be required to connect a Macintosh computer. To connect a Macintosh computer equipped with a Mini DisplayPort to the projector, use a commercially available Mini DisplayPort → DisplayPort converter cable.

Cautions when connecting an HDMI cable

- Use a certified High Speed HDMI® Cable or High Speed HDMI® Cable with Ethernet.

Cautions when connecting a DisplayPort cable

- Use a certified DisplayPort cable.



- Depending on the computer, some time may be required until the image is displayed.
- Some DisplayPort cables (commercially available) have locks.
- To disconnect the cable, press the button on the top of the cable's connector, then pull the cable out.
- No power is supplied from the DisplayPort input connector to the connected device.
- When signals from a device that uses a signal converter adapter are connected to the DisplayPort input connector, in some cases the image may not be displayed.
- When the HDMI output of a computer is connected to the DisplayPort input connector, use a converter (commercially available).

Cautions when using a DVI signal

- When the computer has a DVI output connector, use a commercially available converter cable to connect the computer to the projector's HDMI input connector (only digital video signals can be input).

To connect the computer's DVI output connector to the projector's DisplayPort input connector, use a commercially available converter.

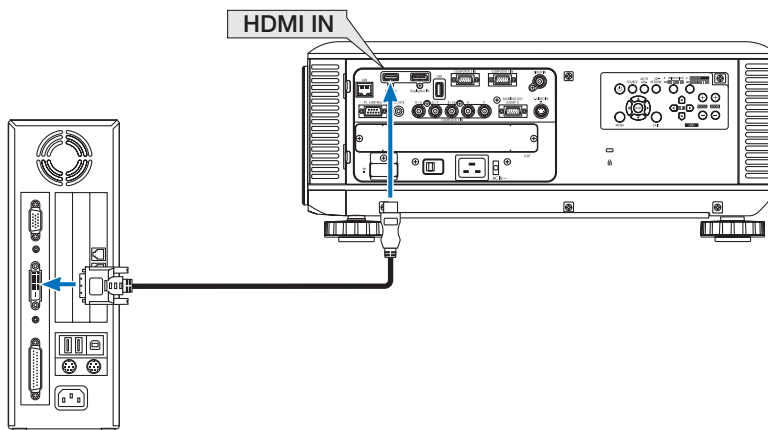

NOTE: When Viewing a DVI Digital Signal

- Use a DVI-to-HDMI cable compliant with DDWG (Digital Display Working Group) DVI (Digital Visual Interface) revision 1.0 standard. The cable should be within 197'5 m long.
 - Turn off the projector and the PC before connecting the DVI-to-HDMI cable.
 - To project a DVI digital signal: Connect the cables, turn the projector on, then select the HDMI input. Finally, turn on your PC. Failure to do so may not activate the digital output of the graphics card resulting in no picture being displayed. Should this happen, restart your PC.
 - Some graphics cards have both analog RGB (15-pin D-Sub) and DVI (or DFP) outputs. Use of the 15-pin D-Sub connector may result in no picture being displayed from the digital output of the graphics card.
 - Do not disconnect the DVI-to-HDMI cable while the projector is running. If the signal cable has been disconnected and then reconnected, an image may not be correctly displayed. Should this happen, restart your PC.
-

Connecting an External Monitor

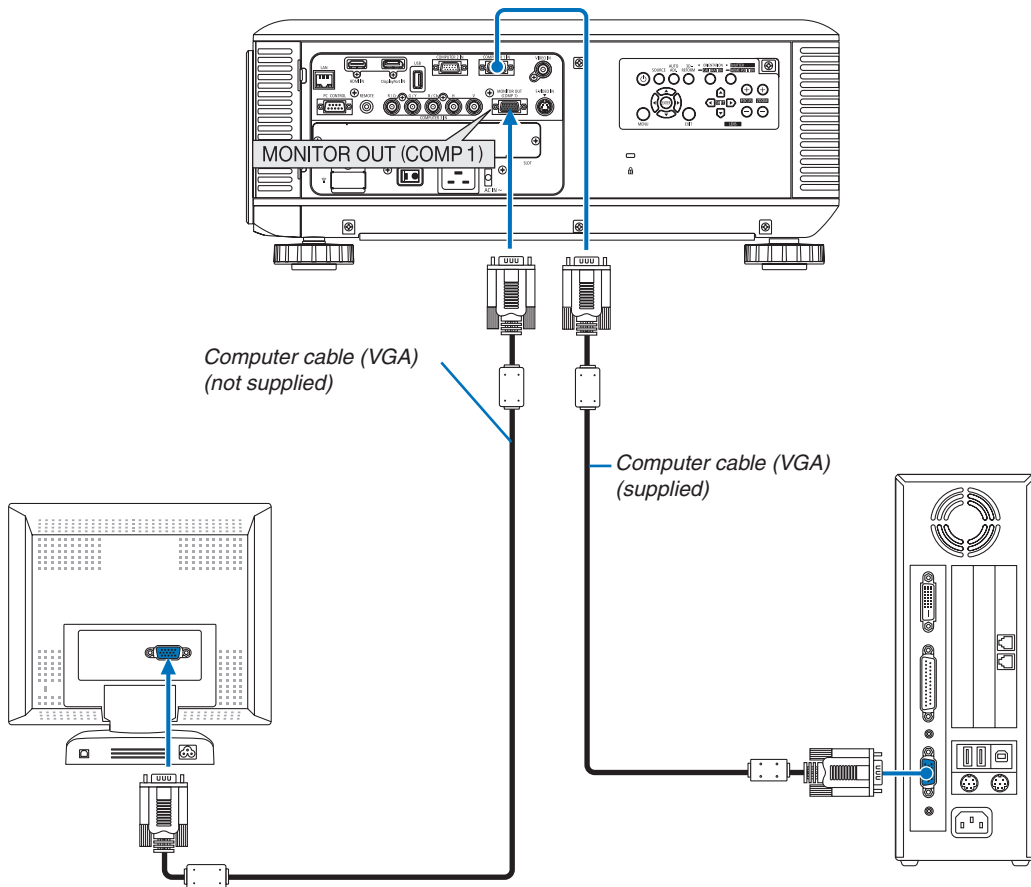

You can connect a separate, external monitor to your projector to simultaneously view on a monitor the computer analog image you're projecting.

NOTE:

- *Daisy chain connection is not possible.*
 - *The signal only from the COMPUTER 1 IN connector will be output to the MONITOR OUT (COMP1) connector.*
 - *When [POWER-SAVING] or [NORMAL2] is selected for [STANDBY MODE] within the on-screen menu, the signal will not be output to the MONITOR OUT (COMP1) connector in standby.*
 - *When the signal from the COMPUTER 3 IN connectors is projected, no video signal will be output to the MONITOR OUT (COMP1) connector.*
-

Connecting Your DVD Player or Other AV Equipment

Connecting Video/S-Video Input

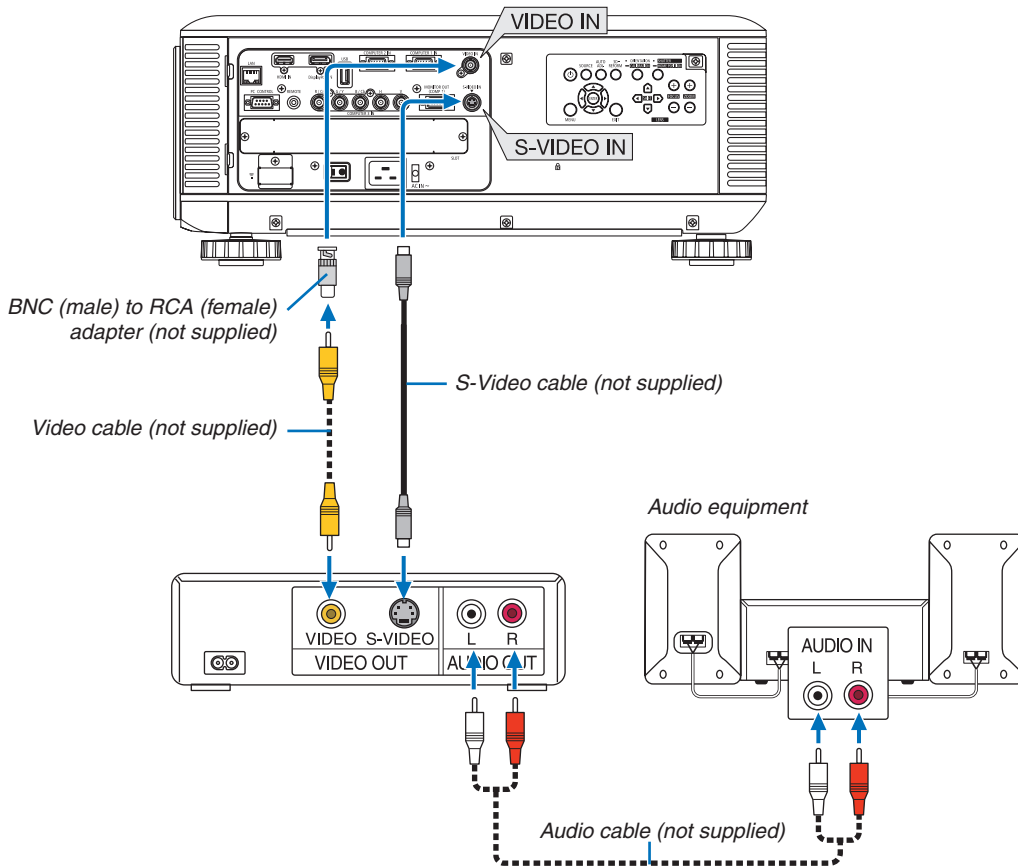

- Select the source name for its appropriate input connector after turning on the projector.

Input connector	SOURCE button on the projector cabinet	Button on the remote control
VIDEO IN	VIDEO	VIDEO
S-VIDEO IN	S-VIDEO	S-VIDEO

NOTE: Refer to your VCR owner's manual for more information about your equipment's video output requirements.

NOTE:

- An image may not be displayed correctly when a Video or S-Video source is played back in fast-forward or fast-rewind via a scan converter.
- Video signals can be projected when a video cable (commercially available) is connected to the Computer 3 video input connector's G/Y connector. In this case, set the on-screen menu's **SETUP** → **OPTION(1)** → **SIGNAL SELECT(COMP3)** to [VIDEO] and select Computer 3 for the input selection.

Connecting Component Input

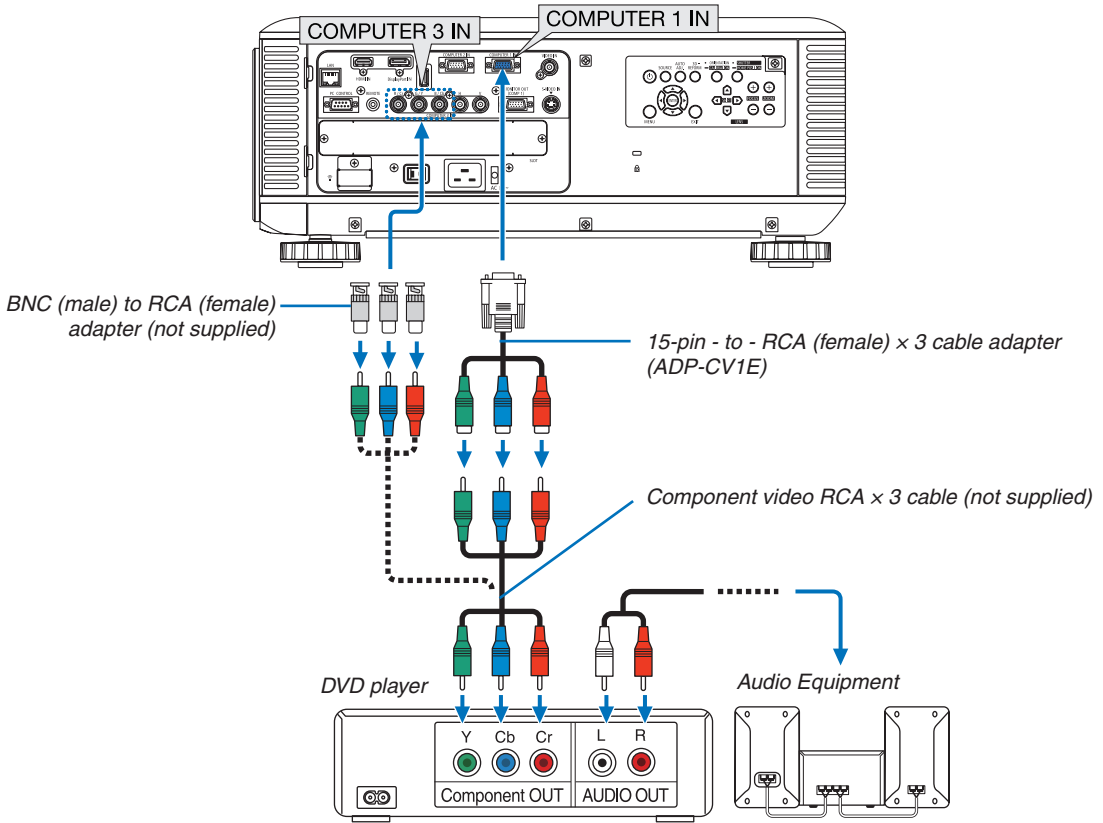

- Select the source name for its appropriate input connector after turning on the projector.

Input connector	SOURCE button on the projector cabinet	Button on the remote control
COMPUTER 1 IN	COMPUTER 1	COMPUTER 1
COMPUTER 2 IN	COMPUTER 2	COMPUTER 2
COMPUTER 3 IN	COMPUTER 3	COMPUTER 3

NOTE:

- Normally the computer signal and component signal are identified and switched automatically. If the signal cannot be identified, however, select the signal at [ADJUST] → [VIDEO] → [SIGNAL TYPE] on the projector's on-screen menu. Select "COMPUTER" or "VIDEO" for the Computer 3 video input connector at [SETUP] → [OPTION (1)] → [SIGNAL SELECT (COMP3)] (→ page 129).
- To connect to a video device with a D connector, use the sold separately D connector converter adapter (model ADP-DT1E).

Connecting HDMI Input

You can connect the HDMI output of your DVD player, hard disk player, Blu-ray player, or notebook type PC to the HDMI IN connector of your projector.

NOTE: The HDMI IN connector supports Plug & Play (DDC2B).

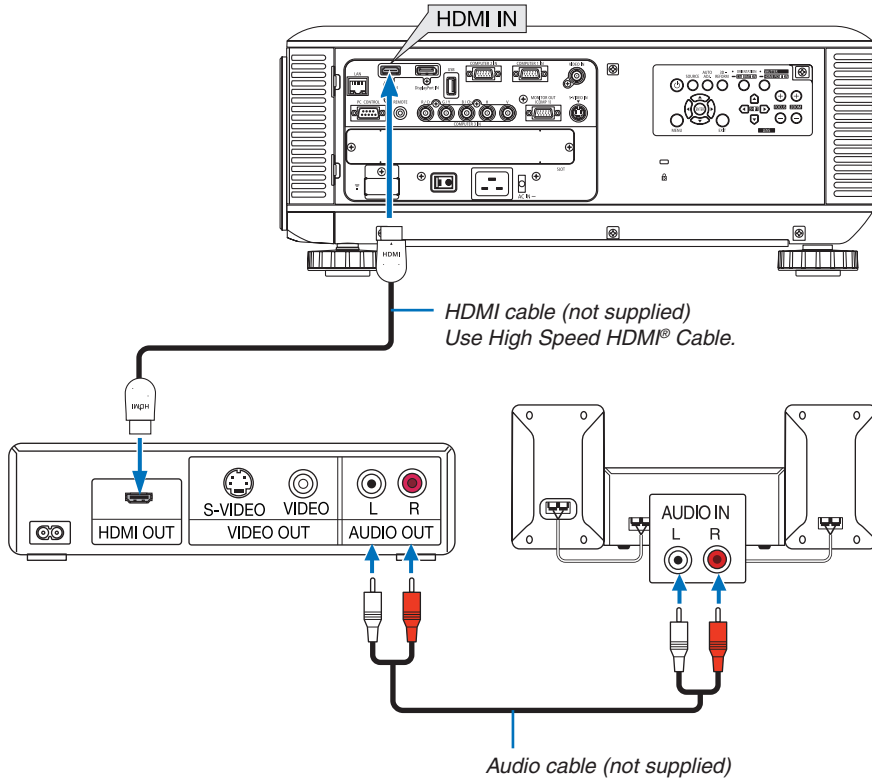

Input connector	SOURCE button on the projector cabinet	Button on the remote control
HDMI IN	 HDMI	HDMI

TIP: For users of audio video equipment with an HDMI connector:

Select "Enhanced" rather than "Normal" if HDMI output is switchable between "Enhanced" and "Normal".

This will provide improved image contrast and more detailed dark areas.

For more information on settings, refer to the instruction manual of the audio video equipment to be connected.

- When connecting the HDMI IN connector of the projector to the DVD player, the projector's video level can be made settings in accordance with the DVD player's video level. In the menu select [ADJUST] → [VIDEO] → [VIDEO LEVEL] and make necessary settings.

Connecting to a Wired LAN

The projector comes standard with a LAN port (RJ-45) which provides a LAN connection using a LAN cable. To use a LAN connection, you are required to set the LAN on the projector menu. Select [APPLICATION MENU] → [NETWORK SETTINGS] → [WIRED LAN]. (→ page 142).

Example of LAN connection

Example of wired LAN connection

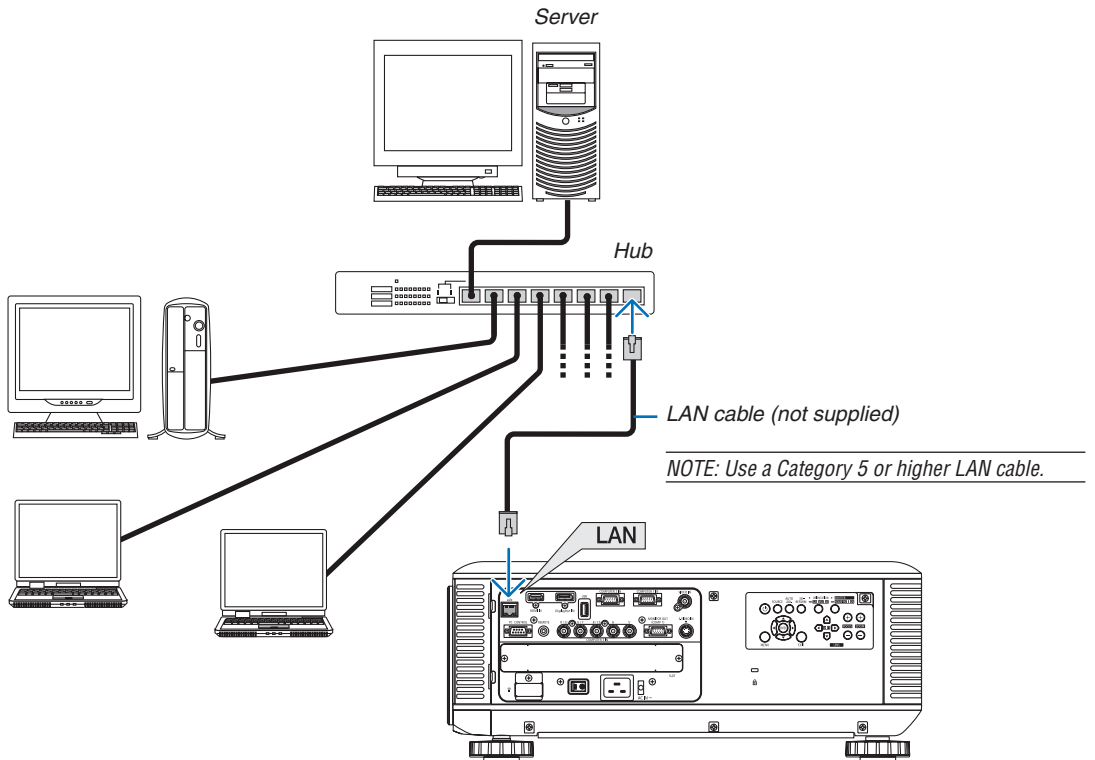

Connecting to a Wireless LAN (sold separately)

The separately sold wireless LAN unit allows you to use a wireless LAN environment. When using the projector in a wireless LAN environment, the IP address and other settings must be made on the projector.

Important:

- If you use the projector with the USB Wireless LAN Unit in the area where the use of wireless LAN equipment is prohibited, remove the USB Wireless LAN Unit from the projector.
- Buy the appropriate USB Wireless LAN Unit for your country or area.

NOTE:

- The green LED on the USB Wireless LAN Unit flashes to show that the USB Wireless LAN Unit is working.
 - Your computer's wireless LAN adapter (or unit) must be complied with Wi-Fi (IEEE802.11b/g/n) standard.
-

Flow of Setting Wireless LAN

Step 1: Attach the USB Wireless LAN Unit to the projector. (→ page 173)

Step 2: Display [NETWORK SETTINGS] from [APPLICATION MENU]. (→ page 141)

Step 3: Select [NETWORK SETTINGS] → [WIRELESS LAN] → [PROFILES] and set [EASY CONNECTION], [PROFILE 1], or [PROFILE 2]. (→ page 142)

TIP:

Access the HTTP server function to set [NETWORK SETTINGS] → [SETTINGS] → [WIRELESS] → [EASY CONNECTION], [PROFILE1], [PROFILE2].

Mounting a wireless LAN unit

NOTE:

- The wireless LAN unit has a front and a back and must be mounted in the wireless LAN port in a specific direction. The port is designed so that the unit cannot be mounted in the opposite direction, but trying to push it in by force could damage the wireless LAN unit port.
 - To prevent damage due to static electricity, touch a nearby metal object (a door knob, aluminum sash, etc.) before touching the wireless LAN unit to eliminate the static electricity from your body.
 - Turn off the main power before mounting and removing the wireless LAN unit.
Mounting and removing the wireless LAN unit while the projector's power is on could damage the wireless LAN unit or result in malfunction on the projector. If the projector should malfunction, turn off the projector's power, turn off the main power switch, and unplug the power cord, then plug the power cord back in.
 - Do not connect any USB device other than the wireless LAN unit to the USB (LAN) port. Also, do not connect the wireless LAN unit to the USB port in the connector section.
-

6. Installation and Connections

1. Press the  button to set the projector to the standby mode, then turn off the main power switch.

2. Remove the plate (port cover).

Loosen the screw security port cover.

- The screw is not removable.

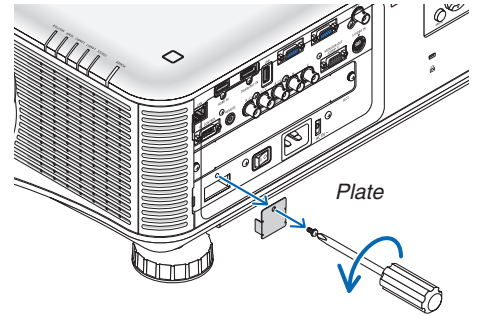

3. Slowly insert the wireless LAN unit into the USB (LAN) port.

- Remove the wireless LAN unit's cap, set the unit with the front (the side with the indicator) facing upwards, hold the back edge and insert the unit gently.

Next, press the wireless LAN unit in with a finger.

- The cap you have removed will be used when the wireless LAN unit is removed, so store it in a safe place.

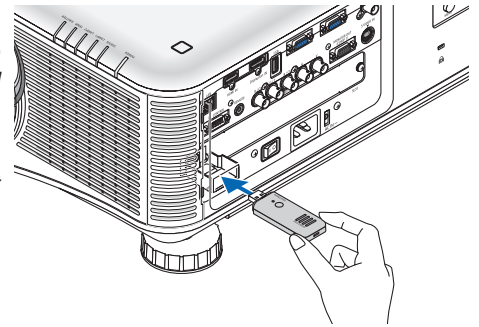

NOTE: If the wireless LAN unit is hard to insert, do not push it in by force.

4. Attach the anti-theft cap for wireless LAN unit.

Use the screw you removed at Step 2 to secure the anti-theft cap.

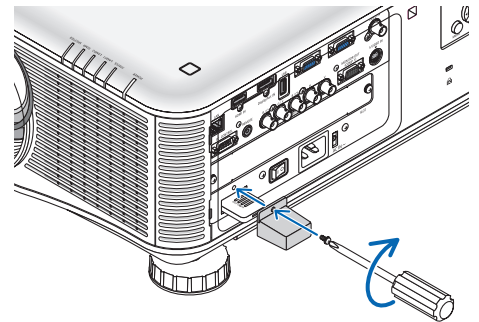

To remove the wireless LAN unit

1. Press the  button to set the projector to the standby mode, then turn off the main power switch.

2. Remove the anti-theft cap.

Loosen the screw and remove the anti-theft cap for the Wireless LAN Unit.

3. Pull out the Wireless LAN Unit from the USB (LAN) port.

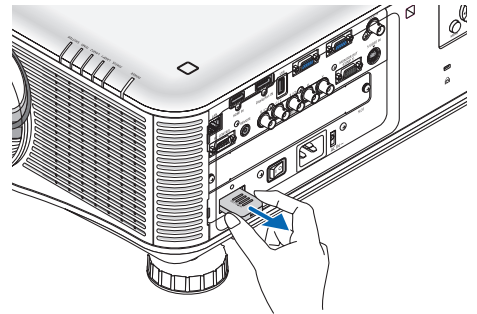
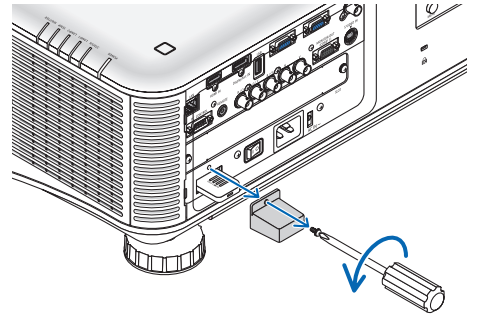

Example of wireless LAN connection
(Network Type → Infrastructure)
(→ page 144)

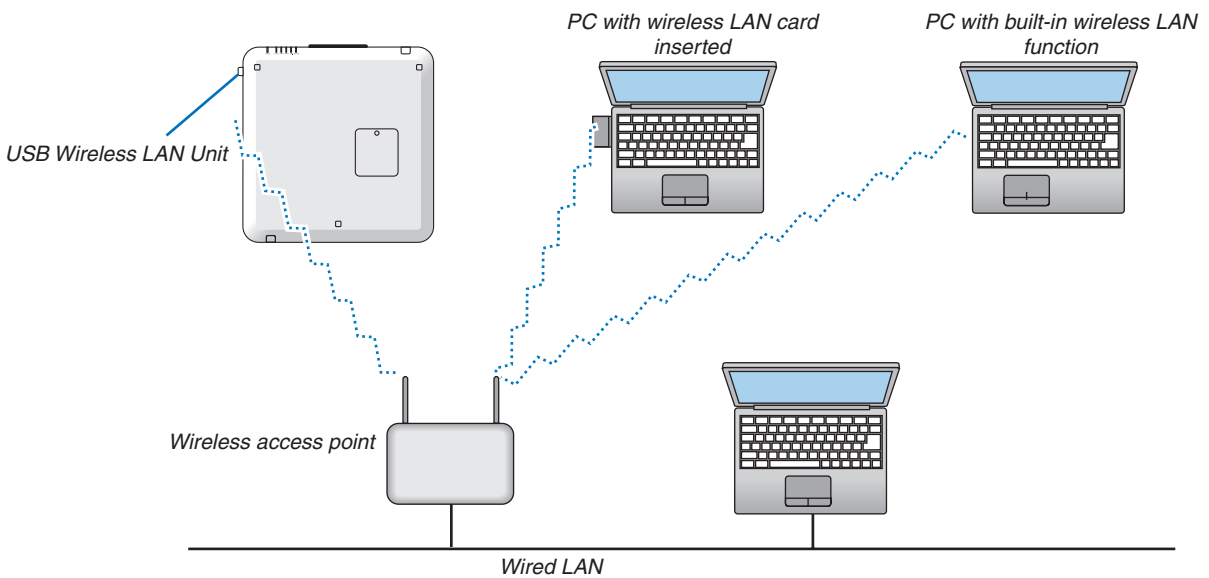

Example of wireless LAN connection (Network Type → Ad Hoc)

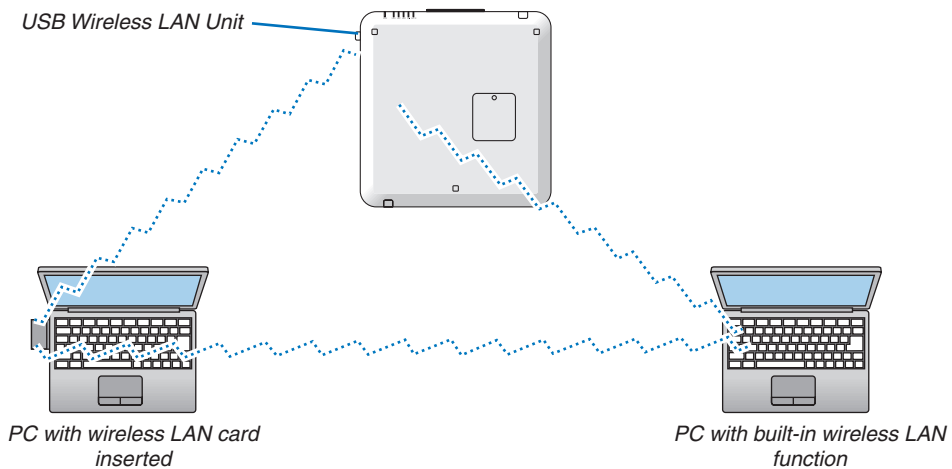

To enable direct communication (i.e., peer-to-peer) between computers and projectors, you need to select the Ad Hoc mode. (→ page 144)

Stacking projectors

The projected image brightness can be doubled by gravity stacking up to two projectors without external support. This is called "Stacking Projection".

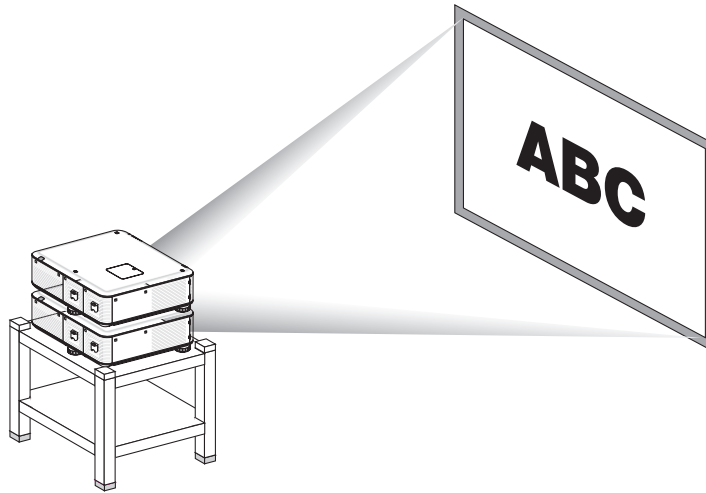

⚠ CAUTION:

A minimum of two persons are required to carry the projector. Otherwise the projector may tumble or drop, causing personal injury.

NOTE:

- *Projectors with different model numbers cannot be gravity stacked. Optional lenses with the same model numbers must be used for stacking projection.*
- *For stacking projectors, attach the supplied three stacking holders to the top of the lower projector. (→ [next page](#))*
- *The stacking projection does not support accuracy for overlaying two images perfectly so that small text and detailed graphics can be clearly read or seen.*
- *Use a commercially available distribution amplifier to both the primary (upper) and the secondary (lower) projectors to distribute signal to two outputs of the two projectors.*
- *Notes for stacking*
 - *Ask your service person for setting up and adjusting projectors.*
 - *Set up the projectors in a place or structure in a way with sufficient strength to support the combined weight of the two projectors. The single projector with a lens weighs up to approximately 21 kg/ 47 lbs.*
 - *To prevent the projectors from falling, fasten them in a way to withstand earthquakes.*
 - *Double stacking will cause room temperature to increase. Ventilate the room well.*
 - *Do not attempt to stack projectors on the ceiling. Gravity stacking cannot be done on the ceiling.*
 - *Warm up the projectors for one hour before the desired projection is obtained.*
 - *Make sure that the position of the upper projector does not exceed its specifications. When setting up the two projectors, adjustable height range for the tilt feet on the upper projector is added to the total adjustable range.*
 - *Set up the projectors so that the projected image shows as little geometric distortions as possible. The lens is different in geometric distortion between wide(+) and tele (-) for zoom.*
 - *Adjust the horizontal lens shift to the lens center.*

Attaching Stacking Holders

Attach three stacking holders to three locations on the top of the lower projector.

Preparation:

Tools required are Phillips screwdriver (plus-head) and three stacking holders packaged with the projector. Loosen the tilt feet (three locations) of the projector.

1. Remove rubber caps and screws at three locations.

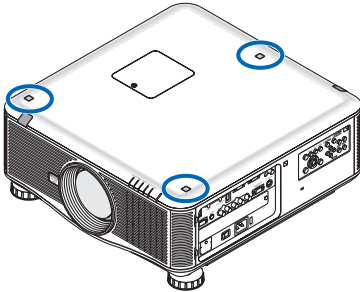

(1) Use your tweezers or nail to pinch and pull up the rubber cap.

(2) Remove the screw from a square hole.

(1)



(2)

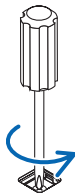

2. Attach the three stacking holders at three locations.

(1) Place a stacking holder in a square hole.

(2) Use the screw removed at Step 1 to fix the stacking holder in the square hole.

(3) Put the rubber cap removed at Step 1 back into the square hole.

- Snap the tabs on both of the rubber cap into the slits on both sides in the square hole.

(1)

(2)

(3)

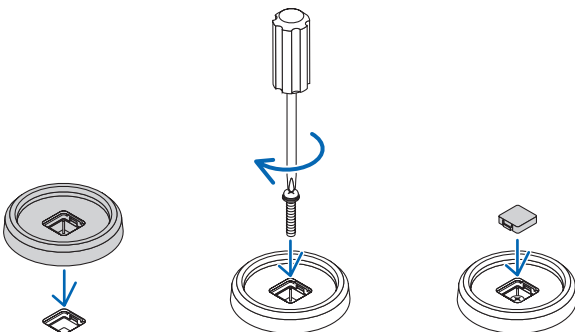

3. Put another projector on the first projector.

Put each tilt foot of the upper projector on the stacking holders (three locations).

- Each tilt foot has a rubber. Place each tilt foot rubber on stacking holders (three locations).

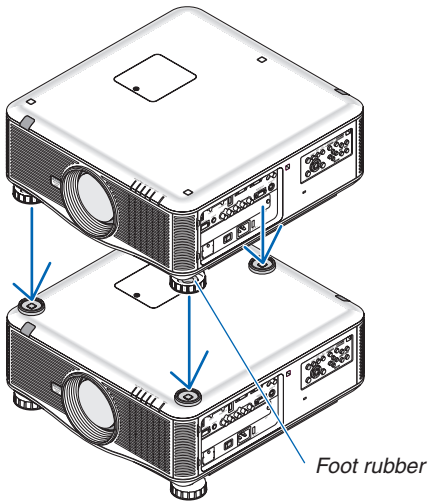

TIP:

- To remove the stacking holders, perform the above steps in reverse order.

7. Maintenance

This section describes the simple maintenance procedures you should follow to clean the filters, the lens, the cabinet, and to replace the lamp and the filters.

① Cleaning the Filters

The air-filter sponge keeps dust and dirt from getting inside the projector and should be frequently cleaned. If the filter is dirty or clogged, your projector may overheat.

*NOTE: The message for filter cleaning will be displayed for one minute after the projector is turned on or off. When the message is displayed, clean the filters. The time to clean the filters is set to [OFF] at time of shipment. (→ page 122)
To cancel the message, press any button on the projector cabinet or the remote control.*

⚠ CAUTION

- Before cleaning the filters, turn off the projector, disconnect the power cord and then allow the cabinet to cool. Failure to do so can result in electric shock or burn injuries.

Preparation: Before cleaning the filters, use a vacuum cleaner to clean the ventilations (inlet). There are two filters on the front (front filter) and left side (side filter). When replacing the filters, buy the optional filter NP02FT in advance.

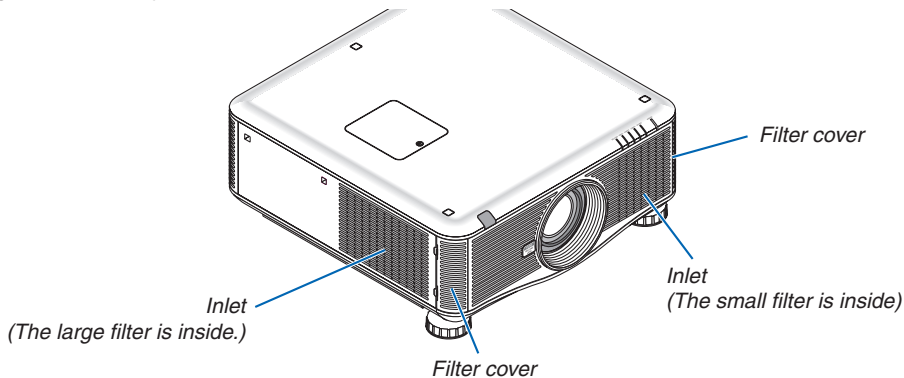

1. Push the positions shown (2 locations) to release the filter cover and remove it.

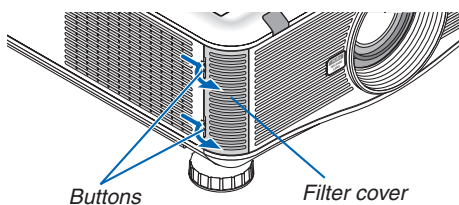

2. Remove the two filters by pulling out.

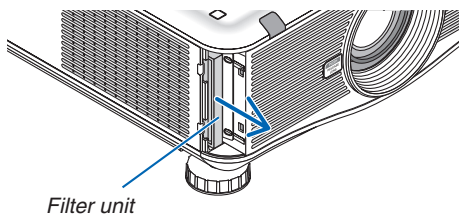

3. Use a vacuum cleaner to vacuum all the dust inside.

Get rid of dust in the accordion filter

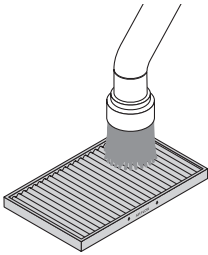

NOTE:

- Whenever you vacuum the filter, use the soft brush attachment to vacuum. This is to avoid damage to the filter.
- Do not wash the filter with water. Doing so can result in filter clogging.

4. Put the filters back into place

The filter cannot be inserted from the outside.

Insert the filter with “↓ AIR FLOW ↓” facing the projector.

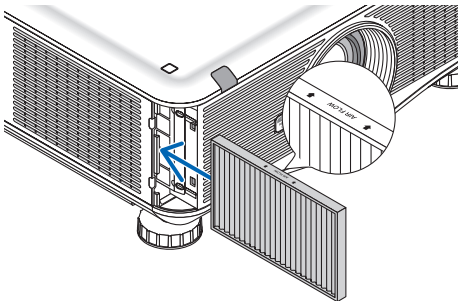

5. Put the filter cover back to the projector cabinet.

Insert the catches on the top and bottom of the filter cover into the grooves in the projector, then press the top and bottom buttons to close.

- Push the filter cover until it clicks into place.

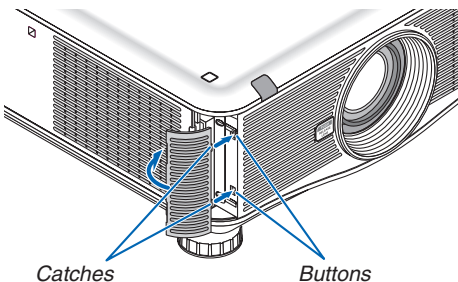

6. Clear the filter usage hours:

Plug the power cord into the wall outlet, turn on the main power switch, and then turn on the projector.

From the menu, select [RESET] → [CLEAR FILTER HOURS], and reset the filter usage hours. (→ page 138)

② Cleaning the Lens

- Turn off the projector before cleaning.
- Use a blower or lens paper to clean the lens, and be careful not to scratch or mar the lens.

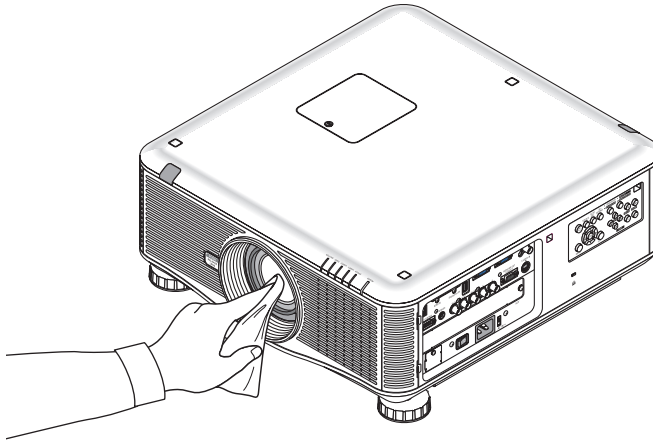

③ Cleaning the Cabinet

Turn off the projector, and unplug the projector before cleaning.

- Use a dry soft cloth to wipe dust off the cabinet.
If heavily soiled, use a mild detergent.
- Never use strong detergents or solvents such as alcohol or thinner.
- When cleaning the ventilation slits or the speaker using a vacuum cleaner, do not force the brush of the vacuum cleaner into the slits of the cabinet.

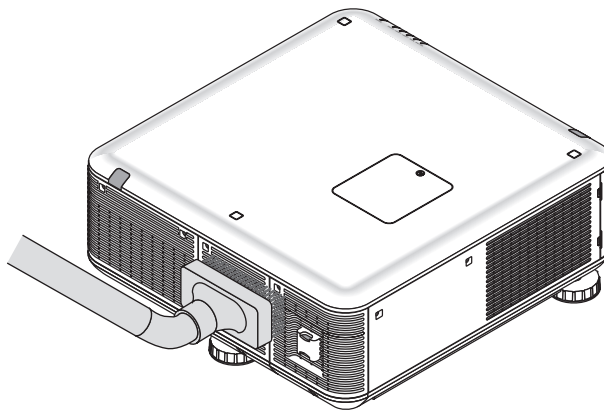

Vacuum the dust off the ventilation slits.

- Clogged ventilation slits may cause a rise in the internal temperature of the projector, resulting in malfunction.
- Do not scratch or hit the cabinet with your fingers or any hard objects
- Contact your dealer for cleaning the inside of the projector.

NOTE: Do not apply volatile agent such as insecticide on the cabinet, the lens, or the screen. Do not leave a rubber or vinyl product in prolonged contact with it. Otherwise the surface finish will be deteriorated or the coating may be stripped off.

4 Replacing the Lamp and the Filters

When the lamp reaches the end of its life, the LAMP indicator in the cabinet will blink red and the message “THE LAMP HAS REACHED THE END OF ITS USABLE LIFE. PLEASE REPLACE THE LAMP 1 (OR 2). USE THE SPECIFIED LAMP FOR SAFETY AND PERFORMANCE.” will appear (*). Even though the lamp may still be working, replace the lamp to maintain the optimal projector performance. After replacing the lamp, be sure to clear the lamp hour meter. (→ page 137)

CAUTION

- DO NOT TOUCH THE LAMP immediately after it has been used. It will be extremely hot. Turn the projector off and then disconnect the power cord. Allow at least one hour for the lamp to cool before handling.
- Use the specified lamp for safety and performance.
- DO NOT REMOVE ANY SCREWS except two (2) lamp cover screw and three (3) lamp housing screws. You could receive an electric shock.
- Do not break the glass on the lamp housing.
Keep finger prints off the glass surface on the lamp housing. Leaving finger prints on the glass surface might cause an unwanted shadow and poor picture quality.
- The projector will turn off and go into standby mode when you continue to use the projector for another 100 hours after the lamp has reached the end of its life. If this happens, be sure to replace the lamp. If you continue to use the lamp after the lamp reaches the end of its life, the lamp bulb may shatter, and pieces of glass may be scattered in the lamp case. Do not touch them as the pieces of glass may cause injury. If this happens, contact your NEC dealer for lamp replacement.

**NOTE: This message will be displayed under the following conditions:*

- for one minute after the projector has been powered on
- when the  (POWER) button on the projector cabinet or the POWER OFF button on the remote control is pressed

To turn off the message, press any button on the projector cabinet or the remote control.

Optional lamp and tools needed for replacement:

- Phillips screwdriver (plus-head)
- Replacement lamp:
NP22LP

Flow of Replacing the Lamp and the Filters

The following procedure is an example for replacing both lamps.

Step 1. Replace the lamp

Step 2. Replace the filters (→ page 185)

Step 3. Clear the lamp usage hours and the filter usage hours (→ page 137, 138)

To replace the lamp:

1. Remove the lamp cover.

- (1) Loosen the two lamp cover screws.
 - The lamp cover screw is not removable.
- (2) Pull the lamp cover towards you and remove it.

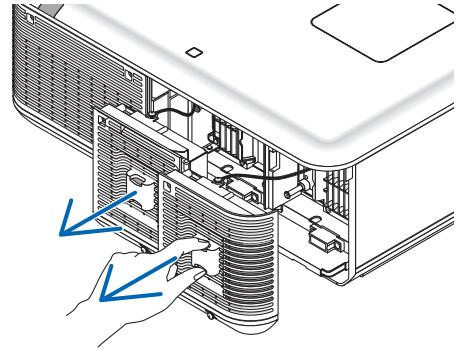
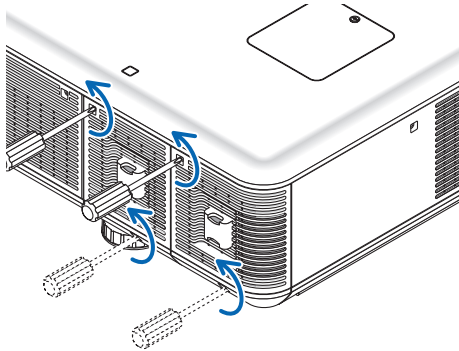

2. Remove the lamp housing.

- (1) Loosen the three screws securing the lamp housing until the phillips screwdriver goes into a freewheeling condition.
 - The three screws are not removable.
 - There is an interlock on this case to prevent the risk of electrical shock. Do not attempt to circumvent this interlock.
- (2) Remove the lamp housing by holding it.

CAUTION:

Make sure that the lamp housing is cool enough to handle before removing it.

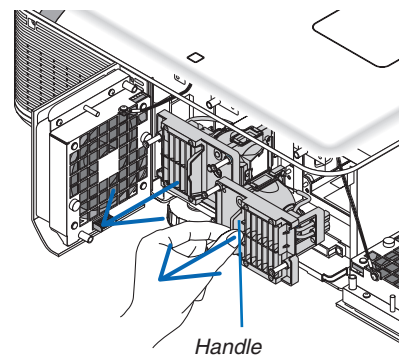
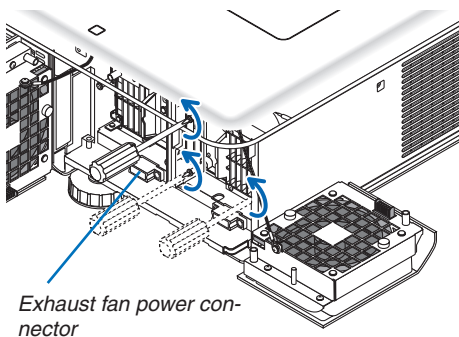

3. Install a new lamp housing.

- (1) Insert a new lamp housing until the lamp housing is plugged into the socket.
- (2) Secure it in place with the three screws.
 - Be sure to tighten the screws.

NOTE:

- Be sure to install both Lamp 1 and Lamp 2. The projector will not turn on unless both the lamps are installed.

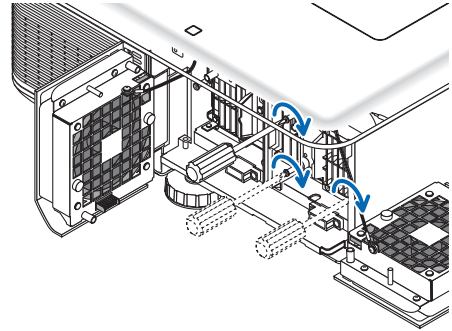
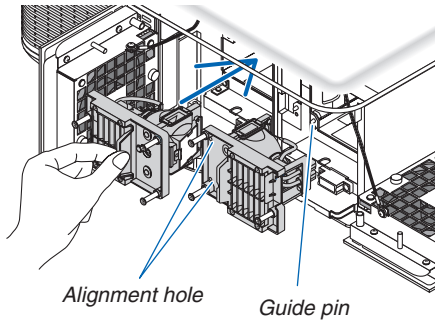

4. Reattach the lamp cover.

- (1) Replace the lamp cover.
- (2) Tighten the two screws to secure the lamp cover.
 - Be sure to tighten the screws.

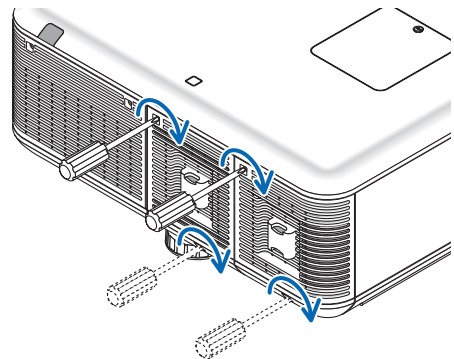
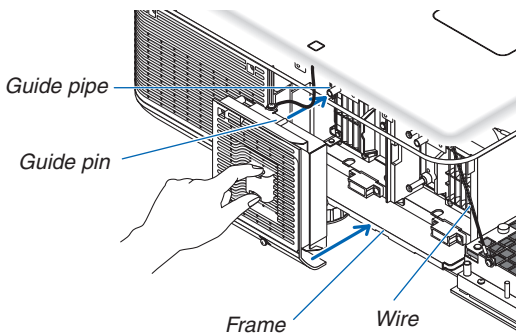

**This completes the lamp replacement.
Go on to the filter replacement.**

NOTE: When you continue to use the projector for another 100 hours after the lamp has reached the end of its life, both LAMP 1 and LAMP 2 indicators will light red and the projector cannot turn on and the menu is not displayed. If this happens, press the HELP button on the remote control for 10 seconds to reset the lamp clock back to zero. When the lamp time clock is reset to zero, the LAMP indicator goes out. When only one lamp is replaced, select [RESET] from the menu to reset the lamp hour used. Do not press the HELP button.

5 Replacing the Filters

There are two filters, one located at the front of the projector and one on the side.
 Optional filters (two filter) are available.
 Small one for the front
 Large one for the left side

NOTE:

- Replace both filters with the new ones at the same time.
- Before replacing the filters, use a vacuum cleaner to vacuum dust and dirt from the vents (inlet) of the projector and use a dry soft cloth to wipe dust off the cabinet.
- The projector contains high-precision parts. Keep out dust and dirt during filter replacement.
- Do not wash the filter with water. Water will damage the filter membrane.
- Attach the filter in the correct orientation. Failure to do so may cause dust and dirt to enter inside the projector, resulting in projector malfunction.

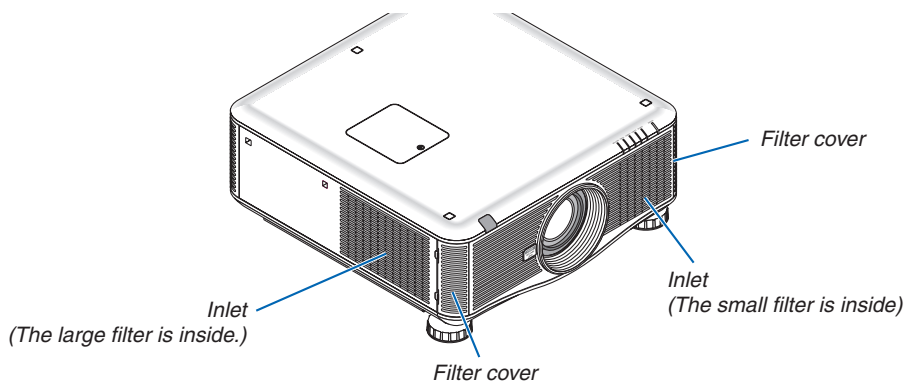

To replace the filters:

1. Push the positions shown (2 locations) to release the filter cover and remove it.

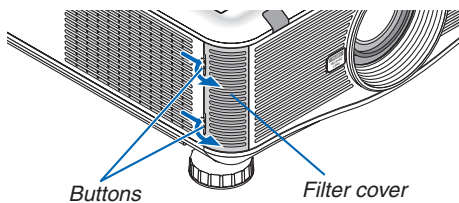

2. Remove the two filters by pulling out.

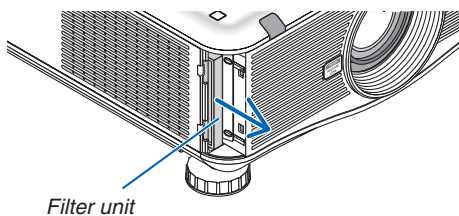

3. Insert new filters.

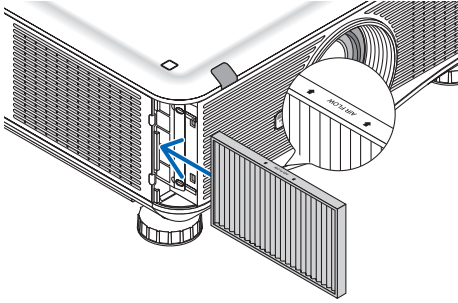

4. Put the filter cover back in.

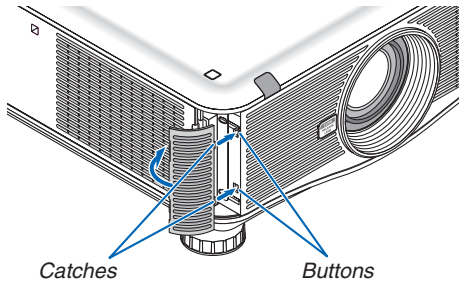

This completes the filter replacement.
Go on to the clearing lamp and filter hour meters.

To clear the lamp usage hours and the filter usage hours:

1. Place the projector where you use it.
2. Plug the power cord into the wall outlet, and then turn on the projector.
3. Clear the lamp usage hours and the filter usage hours.
 1. From the menu, select [RESET] → [CLEAR LAMP HOURS] and reset the lamp usage hours.
 2. Select [CLEAR FILTER HOURS].and reset the filter usage hours. (→ page 138)

8. User Supportware

① Installing Software Program

Installation for Windows software

The software programs except Image Express Utility 2 for Mac support Windows 7, Windows Vista, and Windows XP.

NOTE:

- To install or uninstall each software program, the Windows user account must have “Administrator” privilege (Windows 7, Windows Vista) or “Computer Administrator” privilege (Windows XP).
 - Exit all running programs before installation. If another program is running, the installation may not be completed.
 - To run Virtual Remote Tool or PC Control Utility Pro 4 on Windows XP Home Edition and Windows XP Professional, “Microsoft .NET Framework Version 2.0 or later” is required. The Microsoft .NET Framework Version 2.0 or later is available from Microsoft’s web page. Download and install it on your computer.
-

Image Express Utility 2.0 / PC Control Utility Pro 4

1 Insert the accompanying NEC Projector CD-ROM into your CD-ROM drive.

The menu window will be displayed.

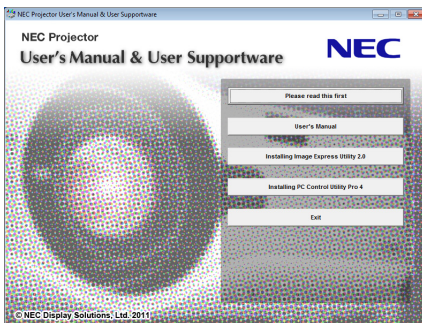

TIP:

If the menu window will not be displayed, try the following procedure.

For Windows 7

1. Click “start” on Windows.
2. Click “All Programs” → “Accessories” → “Run”.
3. Type your CD-ROM drive name (example: “Q:\”) and “LAUNCHER.EXE” in “Name”. (example: Q:\LAUNCHER.EXE)
4. Click “OK”.

the menu window will be displayed.

2 Click a software program you wish to install on the menu window.

The installation will start.

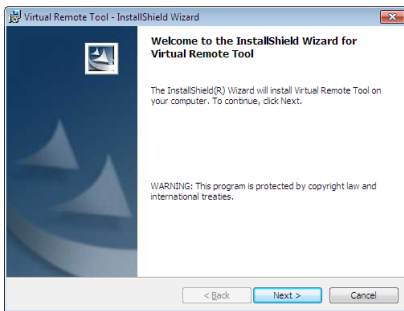

- Follow the instructions on the installer screens to complete the installation.

TIP:

Uninstalling a Software Program

Preparation:

Exit the software program before uninstalling. To uninstall the software program, the Windows user account must have “Administrator” privilege (Windows 7 and Windows Vista) or “Computer Administrator” privilege (Windows XP).

• For Windows 7/Windows Vista

1 Click “Start” and then “Control Panel”.

The Control Panel window will be displayed.

2 Click “Uninstall a program” under “Programs”

The “Programs and Features” window will be displayed.

3 Select the software program and click it.

4 Click “Uninstall/Change” or “Uninstall”.

- When the “User Account Control” window is displayed, click “Continue”.

Follow the instructions on the screens to complete the uninstallation.

• For Windows XP

1 Click “Start” and then “Control Panel”.

The Control Panel window will be displayed.

2 Double-click “Add / Remove Programs”.

The Add / Remove Programs window will be displayed.

3 Click the software program from the list and then click “Remove”.

Follow the instructions on the screens to complete the uninstallation.

Virtual Remote Tool/Viewer PPT Converter 3.0

1. **Connect your computer to the internet and visit our website (<http://www.nec-display.com/dl/en/index.html>).**
2. **Download “Virtual Remote Tool” or “Viewer PPT Converter 3.0” from “Download” and save an “.exe” file to your computer.**

File name is different depending on the version of the software program.

3. **Click the “.exe” file.**

The installation will start.

Follow the instructions on the installer screens to complete the installation.

Installation for Macintosh software

Image Express Utility 2 for Mac supports Mac OS X.

- 1 **Insert the accompanying NEC Projector CD-ROM into your CD-ROM drive.**
The menu window will be displayed.
- 2 **Double-click the CD-ROM icon.**
- 3 **Double-click the “Mac OS X” folder.**
- 4 **Double-click “Image Express Utility 2 (Intel).dmg”.**

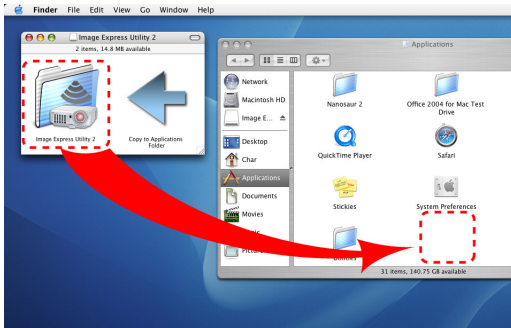

The “Image Express Utility 2” folder will be displayed.

- If your Mac is PowerPC-based, double-click “Image Express Utility 2.dmg”.
- 5 **Move the “Image Express Utility 2” folder to “Applications” folder using a drag-and-drop operation.**

TIP:

• Uninstalling a software program

1. **Put the “Image Express Utility 2” folder to the Trash icon.**
2. **Put the configuration file of Image Express Utility 2 to the Trash icon.**
 - The configuration file of Image Express Utility 2 is located in “/user/your user name/library/Preferences/jp.co.nec.nevt.ImageExpressUtility.plist”.

② Projecting Images or Videos from the Projector over a LAN (Image Express Utility 2.0)

What you can do with Image Express Utility 2.0

- Using Image Express Utility 2.0 allows you to send the screens of your computers to the projector via wired/wireless LAN.

The projected images can be sent from a computer to not only one projector but also to two or more projectors at the same time.

When “Meeting Mode” is used, projected images can be sent and received between two or more computers.

- High-speed, high-quality image transmissions based on NEC’s original compression algorithm**

NEC’s original compression algorithm allows high-quality images to be sent over the network at high speed, from your computer to the projector.

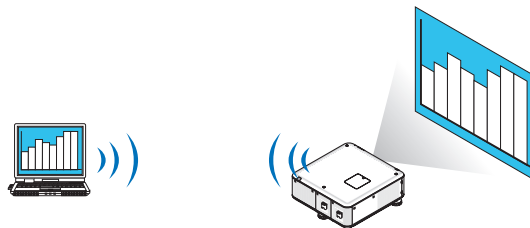

- Simultaneous projection by multiple projectors**

Images can be sent from a computer to not only one projector but also to two or more projectors at the same time.

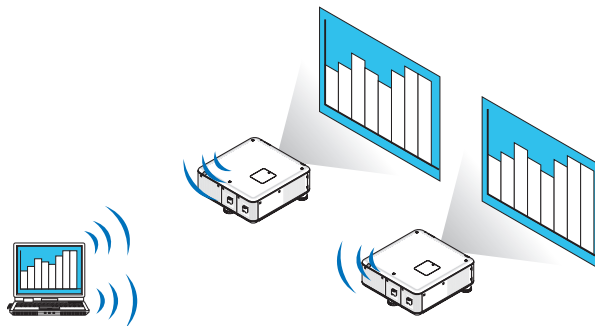

- “Easy Connection” function for connecting wireless LAN**

By using “Easy Connection” function*1, the complicated setting of wireless LAN can be simplified.

*1 This function can be used when Windows XP is used as the OS and when you have a “Computer Administrator” privilege. If the OS is Windows 7/Windows Vista, input of logon password as “Administrator” may be prompted.

- **Projected images can be transferred and saved to computers.**

When “Meeting Mode” is used, projected images can be sent to the computers of all the participants (attendants) of a “Meeting”. The received images can be saved to your computer with a memo (text data) attached.

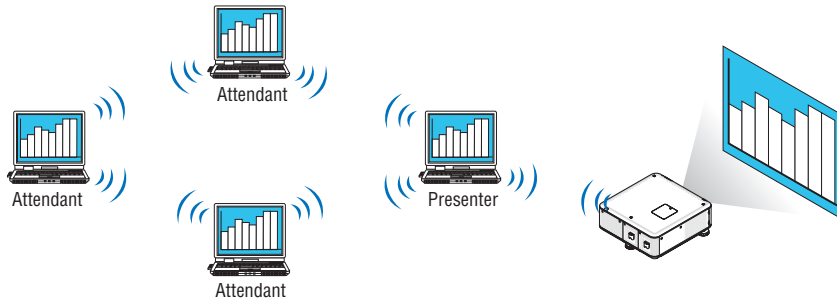

- **1-click switching of presenter**

When switching to another presenter during the conference, the participants (attendants) can simply click a button to switch over to the new presenter.

- **Central management of the projecting computer**

Using the Training Mode allows you to use a single computer (Manager) to manage which computer (Attendant) projects. Possible operation includes switching projecting computers to project from, as well as temporarily terminating communication with the projector.

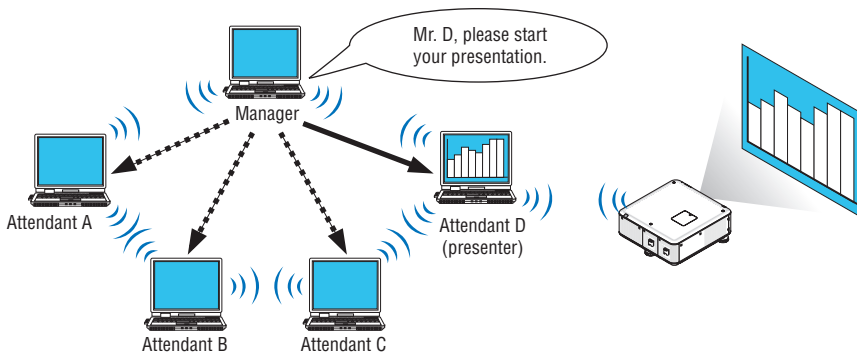

NOTE::

The Training Mode is not installed via the “Typical” installation option when Image Express Utility 2.0 is installed. To use Training Mode, select “Extension” installation option on the install selection screen that is displayed while Image Express Utility 2.0 installation is in progress, and select “Training Mode (Attendant)” or “Training Mode (Manager)”.

Connecting the projector to a LAN

Connect the projector to the LAN by following the instructions in “Connecting to a Wired LAN” (→ page 171), “Connecting to a Wireless LAN” (→ page 172) and “9 Application Menus - NETWORK SETTINGS” (→ page 141)

Basic Operation of Image Express Utility 2.0

This section explains the following three cases as examples of operating Image Express Utility 2.0.

- (1) Transferring images to the projector
- (2) Holding a conference
- (3) Participating in a conference

Sending Images to Projector

• Connecting projector

1 Turn on the power to the projector for which LAN has been set.

2 Click Windows [Start] → [All Programs] → [NEC Projector User Supportware] → [Image Express Utility 2.0] → [Image Express Utility 2.0], in that order.

The “Selection Of Network Connections” window will be displayed.

A list of the network equipment connected to your computer will be displayed.

IMPORTANT:

A screen like the one below is displayed when the software is started on a PC installed with Windows XP Service Pack 2 (SP2) (or later). Click “Unblock” if this is displayed.



3 Select the network equipment that is to be used and click [OK].

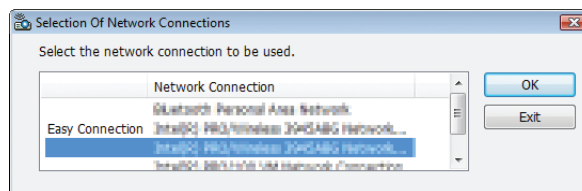

Select the network device displaying “Easy Connection” if the product LAN setting is for “Easy Connection.” This will call up the “Projector List” window.

4 Check(☑) the projector to connect and click [Connect].

If the name of the projector to connect is not on the list or if it is hidden, click [Update].

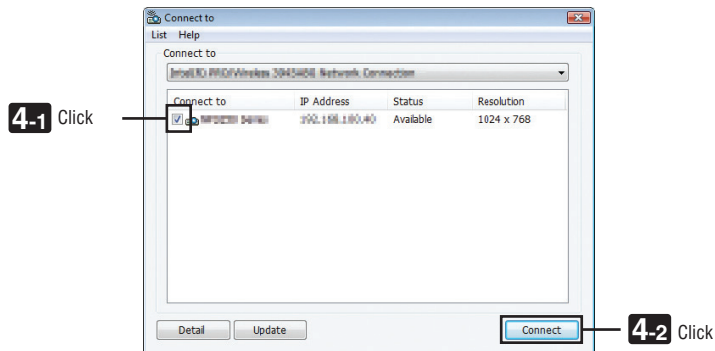

The screen of your computer will be projected from the projector.

At this time, the input signal of the projector will automatically change to "NETWORK".

NOTE:

- When the projector is found, "1280 × 800" will be displayed in the resolution field.

• Transferring images

When your computer is connected to the projector, the screen of the computer is projected from the projector as is. To make your presentation by using a PowerPoint file, open the PowerPoint file and start your presentation.

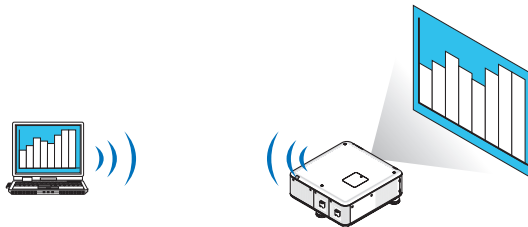

• Stopping or resuming the transmission of images

The transmission of the screen of the computer to the projector can be temporarily stopped and then resumed.

- 1 **Click the projector icon () on the Windows taskbar.**

A pop-up menu will be displayed.

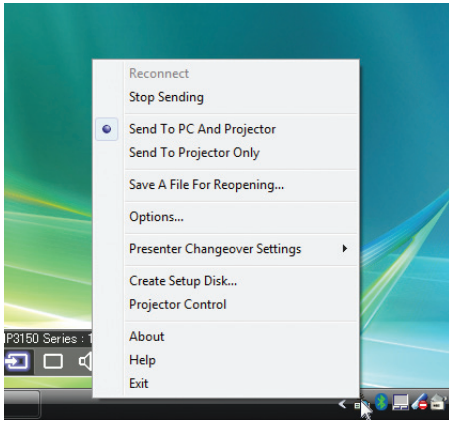

- 2 **Click [Stop Sending].**

The projector icon on the taskbar will change ( → ).

NOTE:

Even if the screen of the computer is changed in this status, the image projected from the projector does not change. To manipulate the screen that should not be disclosed (projected from the projector), stop transmission.

- 3 **Click the projector icon () on the Windows taskbar.**

A pop-up menu will be displayed.

- 4 **Click [Start Sending].**

The projector icon on the taskbar will change ( → ).

The transmission of the screen for the computer will be resumed, and the current screen of the computer will be projected from the projector.

• End the transmission of images

Exit Image Express Utility 2.0.

- 1 **Click the projector icon () on the Windows taskbar.**

A pop-up menu will be displayed.

- 2 **Click [Exit].**

Holding Conferences

- Holding conferences

1 Follow steps 1 through 4 in “Connecting projector” of “Sending Images to Projector” (→ page 193).

The screen of your computer will be projected from the projector.

- Disclose a file to the participants of the conference.

NOTE:

To disclose a file to the participants, selection can be made only in folder units.

Therefore, a folder only having files that can be disclosed to the participants must be created in advance.

1 Click the projector icon () on the Windows taskbar.

A pop-up menu will be displayed.

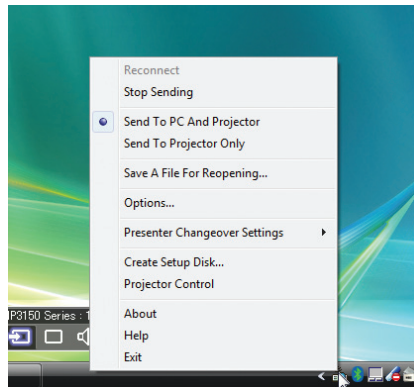

2 Before clicking [Send to PC and Projector], check that there is a “•” mark applied.

3 Click the [Image Express Utility 2.0] button on the taskbar.



The presenter window will be opened.

4 Click [Select Folder].

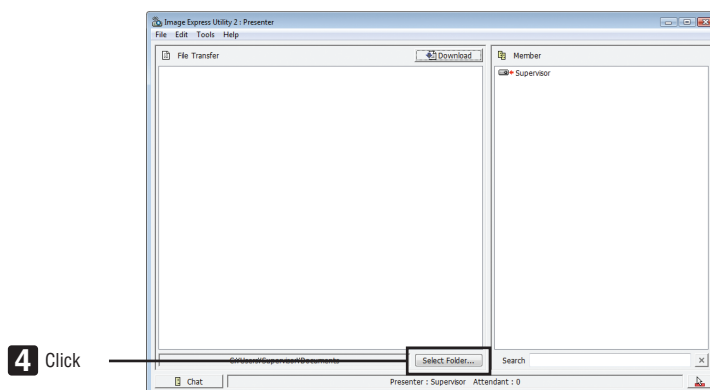

5 Select a folder saving the file to be disclosed to the participants, and click [OK].

The file in the selected folder will be displayed in the list of files to transfer.

6 Click [Download].

The file will be shown to the participants.

NOTE:

When the computer is connected to the projector, the computer screen that is in of being progress is also projected from the projector. To manipulate a screen that should not be shown (not projected), temporarily stop the transmission (→ page 195).

• Ending conference

1 Click [File] in the presenter window, and click [Exit].

You can also end the conference by clicking [x] at the upper right of the presenter window.

Participating in Conference

• Participating in conferences

1 Click Windows [Start] → [All Programs] → [NEC Projector User Supportware] → [Image Express Utility 2.0] → [Image Express Utility 2.0], in that order.

The “Selection Of Network Connections” window will be displayed.

A list of the network equipment connected to your computer will be displayed.

IMPORTANT:

A screen like the one below is displayed when the software is started on a PC installed with Windows XP Service Pack 2 (SP2) (or later). Click “Unblock” if this is displayed.



2 Select the network equipment that is to be used and click [OK].

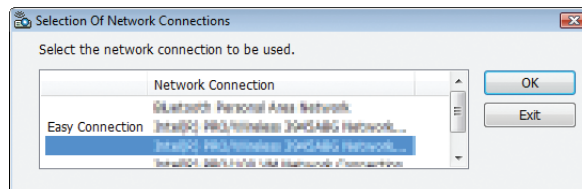

Select the network device displaying “Easy Connection” if the product LAN setting is for “Easy Connection.” This will call up the “Meeting List” window.

3 Click the Meeting Name to participate, and click [Connect].

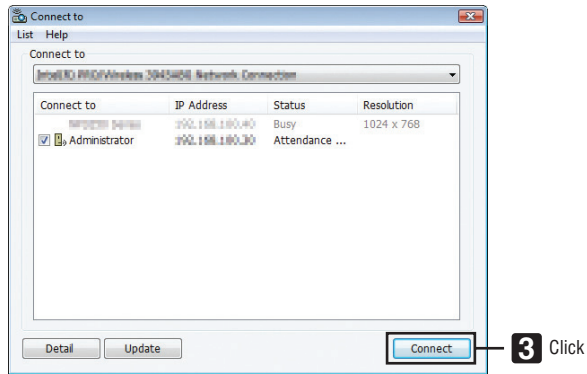

The computer will be connected to the selected conference and the attendant window will be displayed.

If the presenter selects "Send to PC And Projector", the image projected from the projector is displayed in the attendant window.



- **Saving received images**

- 1 Click [Memo] in the attendant window.**

A memo pane will be displayed.

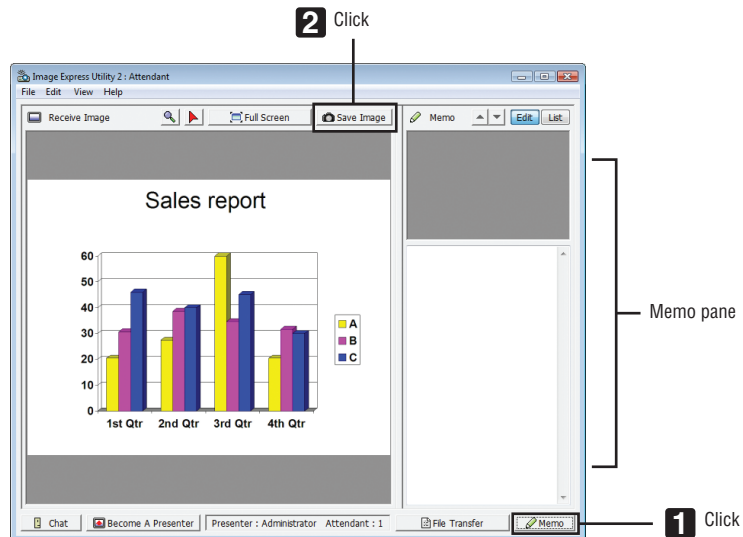

- 2 Click [Save Image] in the attendant window.**

The image displayed in the attendant window will be saved.

- The saved image is added to the memo list and a thumbnail is displayed.
- A memo can be attached to the saved image.

REFERENCE:

- In case of Windows XP, a created file is saved to "My Documents\ImageExpress\" under the default settings. In case of Windows 7/Windows Vista, "Document\ImageExpress\" is the default folder to save a created file.
- A folder is created below the default folder based on the time and date of the conference, and the image is saved to a file in the created folder.

For example, if a conference is held at 11:20 on May 14, 2009, the default folder name on Windows XP will be "My Documents\ImageExpress\2009-05-14_11-20_Meeting Records".

In this folder, an HTML file named "Meeting Records" is created.

The saved image is saved in "Images" folder.

- **Downloading disclosed file**

- 1 Click [File Transfer] in the attendant window.**

The “File Transfer” window will be opened.

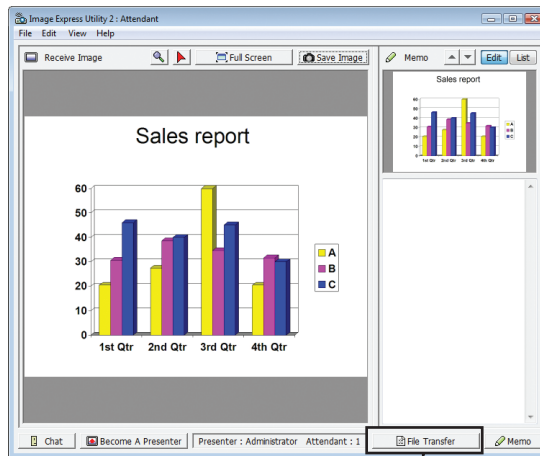

1 Click

- 2 Select a file to download, and click [Download].**

Downloading will begin.

The progress of the downloading is displayed at the lower left of the window.

- 3 When downloading is complete, click [File] in the “File Transfer” window, and click [Exit].**

The “File Transfer” window will be closed.

REFERENCE:

- If “Open After Downloading” is checked, the file is opened by specified Windows application software after downloading is complete.
- In case of Windows XP, a created file is saved to “My Documents\ImageExpress\” under the default settings. In case of Windows 7/Windows Vista, “Document\ImageExpress\” is the default folder to save a created file.
- A folder is created below the default folder based on the time and date of the conference, and the image is saved to a file in the created folder.

For example, if a conference is held at 11:20 on May 14, 2009, the default folder name on Windows XP will be “My Documents\ImageExpress\2009-05-14_11-20_Meeting Records”.

• Changing presenter

Three types of settings may be made to change the presenter: “Not Approved”, “Approved”, and “Changing Prohibited” (these can be selected only by the presenter).

In the following example, “Not Approved” is selected.

- **Click [Become A Presenter] in the attendant window.**

You will change from a participant to a presenter.

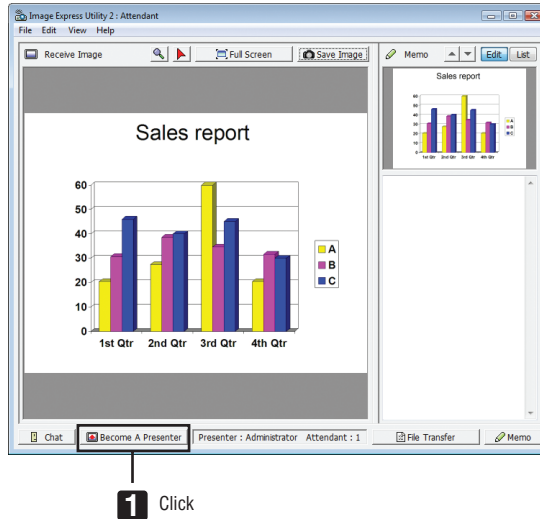

• Leaving conference

Leave the conference and exit Image Express Utility 2.0.

- **Click [File] in the attendant window, and click [Exit].**

You can also leave the conference by clicking [x] at the upper right of the attendant window.

③ Controlling the Projector over a LAN (PC Control Utility Pro 4)

Using the utility software “PC Control Utility Pro 4”, the projector can be controlled from a computer over a LAN.

Control Functions

Power On/Off, signal selection, picture freeze, picture mute, adjusting, error message notification, event schedule.

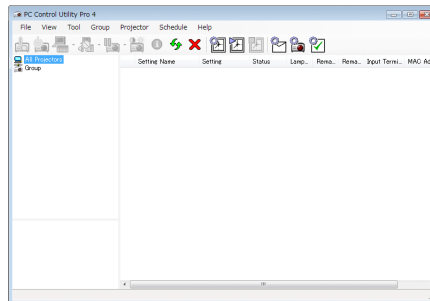

Screen of PC Control Utility Pro 4

This section provides an outline of preparation for use of PC Control Utility Pro 4. For information on how to use PC Control Utility Pro 4, see Help of PC Control Utility Pro 4.

TIP:

- PC Control Utility Pro 4 can be used with a serial connection.

Connect the projector to a LAN.

Connect the projector to the LAN by following the instructions in “Connecting to a Wired LAN” (→ page 171), “Connecting to a Wireless LAN (sold separately)” (→ page 172) and “9 Application Menus - NETWORK SETTINGS” (→ page 141)

Start PC Control Utility Pro 4

Click “Start” → “All programs” or “Programs” → “NEC Projector User Supportware” → “PC Control Utility Pro 4” → “PC Control Utility Pro 4”.

NOTE:

- For the Schedule function of the PC Control utility Pro 4 to work, you must have your computer running and not in standby/sleep mode. Select “Power Options” from the “Control Panel” in Windows and disable its standby/sleep mode before running the scheduler.

[Example] For Windows 7:

Select “Control Panel” → “System and Security” → “Power Options” → “Change when the computer sleeps” → “Put the computer to sleep” → “Never”.

NOTE:

- When [POWER-SAVING] is selected for [STANDBY MODE] from the menu, the projector cannot be turned on via the network (wired LAN/wireless LAN) connection.
When [NORMAL2] is selected for [STANDBY MODE], the projector cannot be turned on via wireless LAN connection.

TIP:

Viewing the Help of PC Control Utility Pro 4

- **Displaying the Help file of PC Control Utility Pro 4 while it is running.**

Click “Help (H)” → “Help (H) ...” of window of PC Control Utility Pro 4 in this order.

The pop-up menu will be displayed.

- **Displaying the help file using the Start Menu.**

Click “Start” → “All programs” or “Programs” → “NEC Projector User Supportware” → “PC Control Utility Pro 4” → “PC Control Utility Pro 4 Help”.

The Help screen will be displayed.

④ Projecting Your Mac's Screen Image from the Projector over a LAN (Image Express Utility 2 for Mac)

Using Image Express Utility 2 for Mac contained allows you to send the Mac's screen image to the projector over a network (wired or wireless LAN).

Image Express Utility 2 for Mac runs on Mac OS X 10.2.8 or later.

It runs on both Mac OS X (PowerPC) and Mac OS X (Intel).

Hereafter, "Image Express Utility 2 for Mac" is abbreviated as "Image Express Utility 2".

What you can do with Image Express Utility 2

- Via the network images on the screen of your Mac can be sent to the projector and projected on the screen.
- One computer can send images to more than one projector.

Operating environment

Supported OS

Mac OS X 10.2.8 or later required

Mac OS X 10.3.0 or later recommended

Processor (CPU)

PowerPC G3 600 MHz processor required

PowerPC G4 800 MHz or higher recommended

or

Intel Core Solo 1.5 GHz or higher required

Memory

256 MB or higher required

Network environment

Wired or wireless LAN required that supports TCP/IP

Only the AirPort and AirPort Extreme wireless LAN cards are guaranteed to work with Image Express Utility 2.

"Easy Connection" supports only AirPort and AirPort Extreme.

Supported resolution

VGA (640 × 480) or higher required

XGA (1024 × 768) recommended

(1024 × 768 - 1280 × 800 recommended)

Supported screen colors

32 thousands of colors, 16.7 million colors required

* 256 or fewer colors are not supported.

Connecting the projector to a LAN

Connect the projector to the LAN by following the instructions in "Connecting to a Wired LAN" (→ page 171), "Connecting to a Wireless LAN" (→ page 172) and "9 Application Menus - NETWORK SETTINGS" (→ page 141)

3 Double-click the “Image Express Utility 2” icon in the “Image Express Utility 2” folder.



Image Express Utility 2

- At the initial start, the “License Agreement” window is displayed.
Thoroughly read the agreement shown on the screen, and click “I accept the terms in the license agreement” and the [OK] button.
Next, the “Authenticate” window will be displayed.

4 Enter the administrator name and password of your Macintosh computer, and click the [OK] button.



The [Projector Selection] window will be displayed.

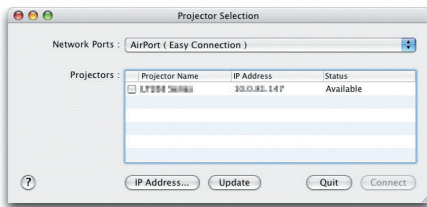

5 Check the () check box to the left of the projector name to connect and click [Connect].

The Macintosh computer and the projector are connected via wireless LAN, and images on the Macintosh screen are projected from the projector.

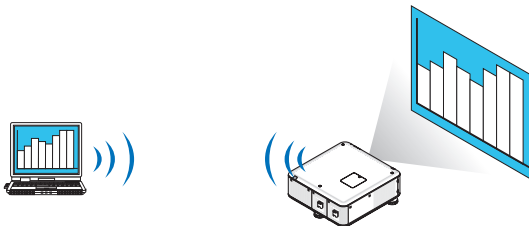

Stopping/Restarting Image Transmission

- Stopping image transmission

1 Click [Tools] on the menu bar, and click [Stop Sending].

Image transmission is temporarily stopped.

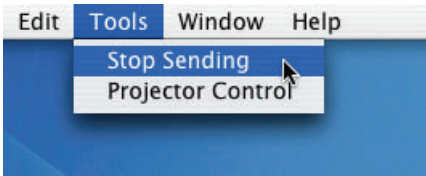

- Restarting image transmission

1 Click [Tools] on the menu bar, and click [Start Sending].

Image transmission is started again.

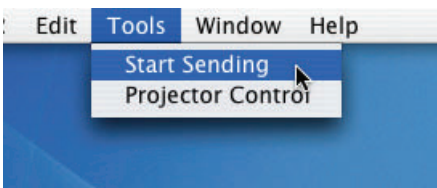

Exiting Image Express Utility 2

1 Click [Image Express Utility 2] on the menu bar, and click [Quit Image Express Utility 2].

Image Express Utility 2 is exited.

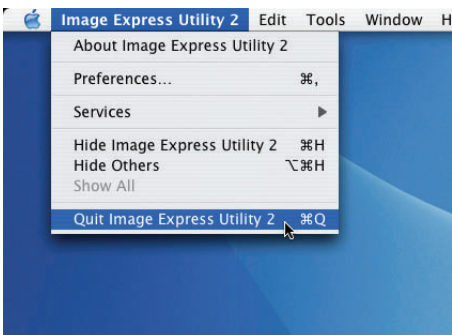

5 Operating the Projector Via the LAN (Virtual Remote Tool)

Using the software program “Virtual Remote Tool” that you can download from our web site, Virtual Remote screen (or toolbar) can be displayed on your computer screen.

This will help you perform operations such as projector’s power on or off and signal selection via a LAN connection. It is also used to send an image to the projector and register it as the logo data of the projector. After registering it, you can lock the logo to prevent it from changing.

Control Functions

Power On/Off, signal selection, picture freeze, picture mute, Logo transfer to the projector, and remote control operation on your PC.

Virtual Remote screen



Remote Control Window

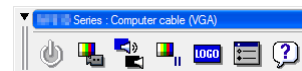

Toolbar

This section provides an outline of preparation for use of Virtual Remote Tool.

For information on how to use Virtual Remote Tool, see Help of Virtual Remote Tool. (→ page 209)

NOTE:

- Logo data (graphics) that can be sent to the projector with Virtual Remote Tool has the following restrictions:
 - File size: 256 KB or less
 - Image size (resolution): the native resolution of the projector
 - File format: JPEG
- The logo data that is sent with Virtual Remote Tool will be displayed at the center of the screen. Its surrounding will be painted out in black.
- Once you have changed the background selection from the default “NEC logo” to another selection, you cannot return the logo to the default “NEC logo” even after using [RESET]. To put the default “NEC logo” back in the background logo, you need to register it as the background logo by using the image file (\\Logo\NEC_logo_black_WUXGA.jpg; NEC_logo_black_XGA.jpg; NEC_logo_black_1280x800.jpg) included on the supplied NEC Projector CD-ROM.

TIP:

- Virtual Remote Tool can be used also with a serial connection.
- To download or update Virtual Remote Tool, visit our website: <http://www.nec-display.com/dl/en/index.html>

Connect the projector to a LAN.

Connect the projector to the LAN by following the instructions in “Connecting to a Wired LAN” (→ page 171), “Connecting to a Wireless LAN (sold separately)” (→ page 172) and “9 Application Menus - NETWORK SETTINGS” (→ page 141)

Start Virtual Remote Tool

Start using the shortcut icon

- Double-click the shortcut icon  on the Windows Desktop.

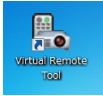

Start from the Start menu

- Click [Start] → [All Programs] or [Programs] → [NEC Projector User Supportware] → [Virtual Remote Tool] → [Virtual Remote Tool].

When Virtual Remote Tool starts for the first time, “Easy Setup” window will be displayed.

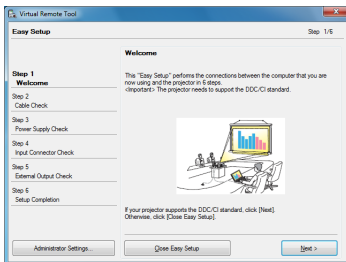

The “Easy Setup” feature is not available on this model. Click “Close Easy Setup”.

Closing the “Easy Setup” window will display the “Projector List” window.

Select your projector you wish to connect. This will display the Virtual Remote screen.



TIP:

- The Virtual Remote Tool screen (or Toolbar) can be displayed without displaying “Easy Setup” window. To do so, click to place a check mark for “ Do not use Easy Setup next time” on the screen.

NOTE:

- When [POWER-SAVING] is selected for [STANDBY MODE] from the menu, the projector cannot be turned on via the network (wired LAN/wireless LAN) connection. When [NORMAL2] is selected for [STANDBY MODE], the projector cannot be turned on via wireless LAN connection.

Exiting Virtual Remote Tool

1 Click the Virtual Remote Tool icon  on the Taskbar.

The pop-up menu will be displayed.

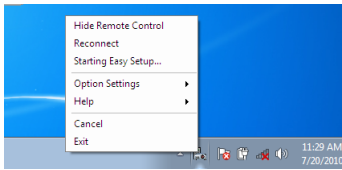

2 Click “Exit”.

The Virtual Remote Tool will be closed.

Viewing the help file of Virtual Remote Tool

• Displaying the help file using the taskbar

1 Click the Virtual Remote Tool icon  on the taskbar when Virtual Remote Tool is running.

The pop-up menu will be displayed.

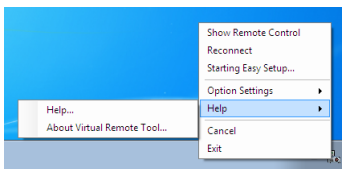

2. Click “Help”.

The Help screen will be displayed.

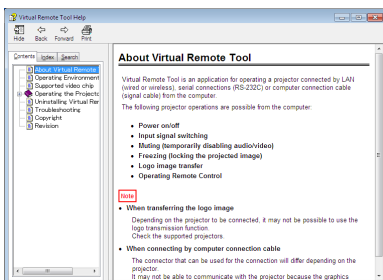

• Displaying the help file using the Start Menu.

1. Click “Start”. “All programs” or “Programs”. “NEC Projector User Supportware”. “Virtual Remote Tool”. and then “Virtual Remote Tool Help” in this order.

The Help screen will be displayed.

⑥ Converting PowerPoint files to Slides (Viewer PPT Converter 3.0)

Using Viewer PPT Converter 3.0 allows you to convert PowerPoint files into JPEG files. Converted JPEG files and Index files (.idx) can be saved to a USB memory. When the USB memory inserted into the projector, these JPEG files and Index files (.idx) can be displayed with the viewer function of the projector without connecting a computer.

NOTE:

When Viewer PPT Converter 3.0 has been installed, once start Viewer PPT Converter 3.0 once with the privilege used for installation. Then exit from Viewer PPT Converter 3.0 without doing anything.

• Starting

Click Window's [Start] → [All Programs] → [NEC Projector User Supportware] → [Viewer PPT Converter 3.0] → [Viewer PPT Converter 3.0], in that order.

NOTE:

• When installing Viewer PPT Converter 3.0 onto a computer that has PowerPoint installed, Viewer PPT Converter 3.0 is automatically registered as a Power-Point add-in.

It is necessary to cancel Viewer PPT Converter 3.0 add-in before uninstalling Viewer PPT Converter 3.0.

Refer to Viewer PPT Converter 3.0 Help to unregister the add-in.

• The projector does not support the add-in's "Run Slide Show".

Converting PowerPoint files and saving them to a USB memory

1. Insert the USB memory into the USB port of the computer.

2. On Windows, click "Start" → "All programs" → "NEC Projector UserSupportware" → "Viewer PPT Converter 3.0" → "Viewer PPT Converter 3.0".

Viewer PPT Converter 3.0 will start.

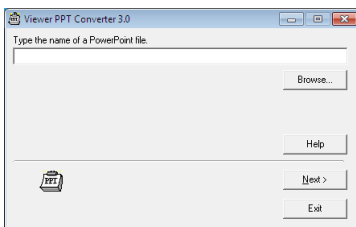

3. Click "Brows..." and select a PowerPoint file you wish to convert, and then click "Open".

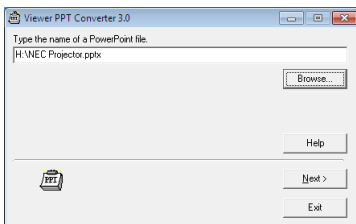

4. Click "Next".

5. Select the USB memory drive for “Card Drive” and type in “Index name”.

Index name must be eight alphanumeric characters or less. 2-byte character and file with a long filename cannot be used.

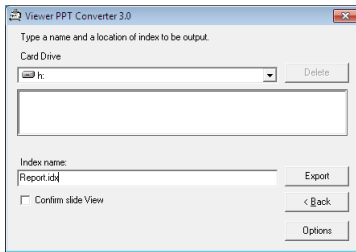

6. Click “Export”.

A confirmation message will be displayed.

7. Click “OK”.

Exporting a file will start.

8. Click “OK”.

9. Click “Exit”.

Viewer PPT Converter 3.0 will exit.

10. Remove the USB memory from the computer.

NOTE:

- *Before removing the USB memory from the USB port of the computer, click the “Safe to Remove Hardware” icon on the taskbar.*

9. Appendix

1 Throw distance and screen size

Optional bayonet style lenses can be used on this projector. Refer to the information on this page and use a lens suited for the installation environment (screen size and throw distance). For instructions on mounting the lens, see page 162. Each number provided in the table below means the throw distance between the lens surface and the screen.

Tables of screen sizes and dimensions

[PX750U2/PX700W2]

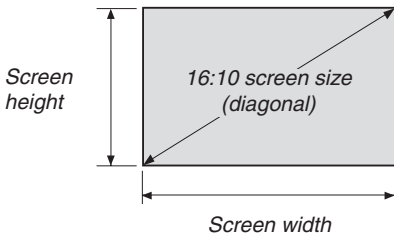

Size (inches)	Screen width		Screen height	
	(inches)	(cm)	(inches)	(cm)
40	33.9	86.2	21.2	53.8
60	50.9	129.2	31.8	80.8
80	67.8	172.3	42.4	107.7
100	84.8	215.4	53.0	134.6
120	101.8	258.5	63.6	161.5
150	127.2	323.1	79.5	201.9
200	169.6	430.8	106.0	269.2
240	203.5	516.9	127.2	323.1
300	254.4	646.2	159.0	403.9
400	339.2	861.6	212.0	538.5
500	424.0	1077.0	265.0	673.1

[PX800X2]

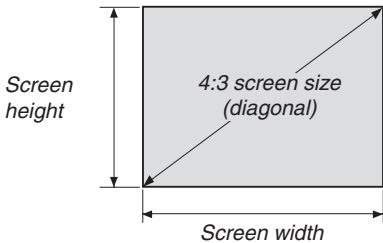

Size (inches)	Screen width		Screen height	
	(inches)	(cm)	(inches)	(cm)
40	32	81.3	24	61.0
60	48	121.9	36	91.4
80	64	162.6	48	121.9
100	80	203.2	60	152.4
120	96	243.8	72	182.9
150	120	304.8	90	228.6
200	160	406.4	120	304.8
240	192	487.7	144	365.8
300	240	609.6	180	457.2
400	320	812.8	240	609.6
500	400	1016.0	300	762.0

Lens types and throw distance

unit = m

[PX750U2]

Screen size	Lens model name						
	NP16FL	NP17ZL	NP18ZL	NP19ZL	NP20ZL	NP21ZL	NP31ZL
40"							0.6 – 0.8
50"	0.8	1.3 – 1.9	1.8 – 2.4	2.4 – 4.0	3.8 – 5.8	5.6 – 8.9	0.8 – 1.0
60"	1.0	1.6 – 2.3	2.2 – 2.9	2.8 – 4.8	4.6 – 7.0	6.8 – 10.7	1.0 – 1.2
80"	1.3	2.2 – 3.1	3.0 – 3.9	3.8 – 6.4	6.2 – 9.3	9.1 – 14.4	1.3 – 1.6
100"	1.7	2.7 – 3.9	3.7 – 4.9	4.8 – 8.0	7.7 – 11.7	11.5 – 18.1	1.6 – 2.0
120"	2.0	3.3 – 4.7	4.5 – 5.9	5.8 – 9.6	9.3 – 14.1	13.8 – 21.7	2.0 – 2.5
150"	2.5	4.1 – 5.8	5.6 – 7.4	7.2 – 12.0	11.7 – 17.6	17.4 – 27.3	2.5 – 3.1
200"	3.4	5.5 – 7.8	7.5 – 9.9	9.7 – 16.1	15.6 – 23.5	23.3 – 36.4	3.3 – 4.1
240"	4.1	6.6 – 9.4	9.1 – 11.9	11.6 – 19.3	18.8 – 28.3	28.0 – 43.8	4.0 – 5.0
300"	5.1	8.2 – 11.7	11.3 – 14.9	14.5 – 24.1	23.5 – 35.4	35.0 – 54.8	5.0 – 6.2
350"							5.8 – 7.3
400"							6.6 – 8.3
450"							7.5 – 9.4
500"							8.3 – 10.4

TIP

Calculation of the throw distance from the screen size

NP16FL lens throw distance (m) = $H \times 0.8$: 0.8 m (min.) to 5.1 m (max.)

NP17ZL lens throw distance (m) = $H \times 1.3$ to $H \times 1.8$: 1.3 m (min.) to 11.7 m (max.)

NP18ZL lens throw distance (m) = $H \times 1.7$ to $H \times 2.3$: 1.8 m (min.) to 14.9 m (max.)

NP19ZL lens throw distance (m) = $H \times 2.2$ to $H \times 3.7$: 2.4 m (min.) to 24.1 m (max.)

NP20ZL lens throw distance (m) = $H \times 3.6$ to $H \times 5.4$: 3.8 m (min.) to 35.4 m (max.)

NP21ZL lens throw distance (m) = $H \times 5.3$ to $H \times 8.3$: 5.6 m (min.) to 54.8 m (max.)

NP31ZL lens throw distance (m) = $H \times 0.8$ to $H \times 0.9$: 0.6 m (min.) to 10.4 m (max.)

"H" (Horizontal) refers to the screen width.

* Figures differ by several % with the table above because the calculation is approximate.

Ex.: Throw distance when using the PX750U2 to project on a 150" screen using the NP18ZL lens:

According to the "Screen Size (for reference)" table (→ page 212), H (screen width) = 323.1 cm.

The throw distance is $323.1 \text{ cm} \times 1.7$ to $323.1 \text{ cm} \times 2.3$ = 549.3 cm to 743.13 cm (because of the zoom lens).

Projection range for the different lenses

[PX750U2]

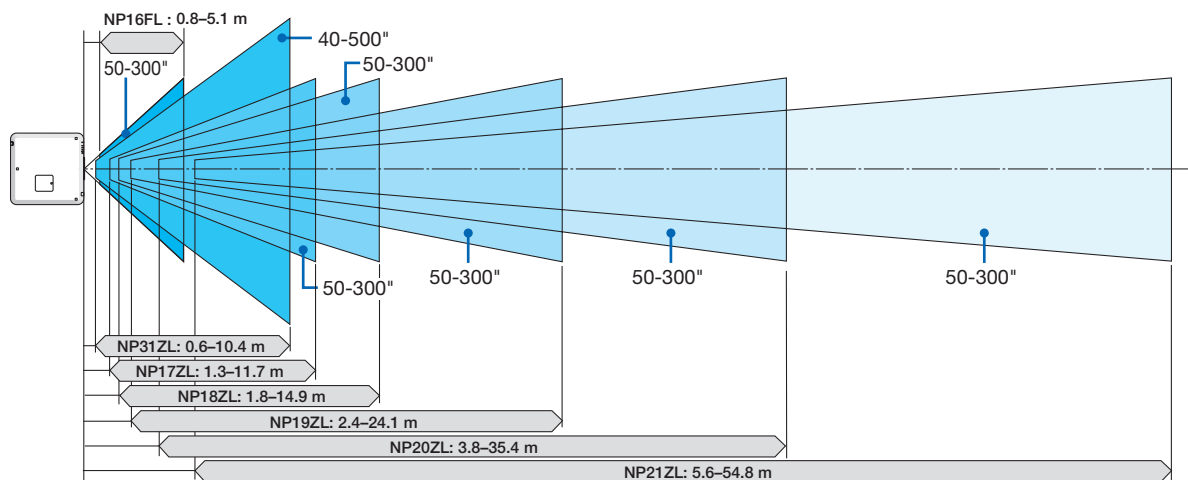

[PX700W2]

Screen size	Lens model name					
	NP06FL	NP07ZL	NP08ZL	NP09ZL	NP10ZL	NP31ZL
40"		1.1 – 1.6	1.5 – 2.0	1.9 – 3.9	3.8 – 7.3	0.7 – 0.8
50"	0.8	1.4 – 2.0	1.9 – 2.6	2.4 – 4.9	4.8 – 9.1	0.8 – 1.1
60"	1.0	1.7 – 2.4	2.3 – 3.1	2.9 – 5.9	5.8 – 11.0	1.0 – 1.3
80"	1.4	2.3 – 3.1	3.1 – 4.1	3.9 – 7.9	7.8 – 14.7	1.4 – 1.7
100"	1.7	2.9 – 3.9	3.9 – 5.2	4.9 – 9.9	9.7 – 18.4	1.7 – 2.1
120"	2.1	3.5 – 4.7	4.7 – 6.2	5.9 – 11.9	11.7 – 22.1	2.1 – 2.6
150"	2.6	4.4 – 5.9	5.9 – 7.8	7.4 – 14.9	14.7 – 27.7	2.6 – 3.2
200"	3.5	5.9 – 7.9	7.9 – 10.4	9.9 – 19.9	19.6 – 36.9	3.5 – 4.3
240"		7.1 – 9.5	9.5 – 12.5	11.9 – 23.9	23.5 – 44.3	4.2 – 5.2
300"		8.9 – 11.9	11.9 – 15.7	14.9 – 29.9	29.5 – 55.5	5.2 – 6.5
350"		10.3 – 13.9	13.8 – 18.3	17.4 – 34.9	34.4 – 64.7	6.1 – 7.6
400"		11.8 – 15.9	15.8 – 20.9	20.0 – 39.9	39.3 – 74.0	7.0 – 8.7
450"		13.3 – 17.9	17.8 – 23.5	22.5 – 44.9	44.3 – 83.3	7.8 – 9.8
500"		14.8 – 19.9	19.8 – 26.2	25.0 – 49.9	49.2 – 92.5	8.7 – 10.9

TIP

Calculation of the throw distance from the screen size

NP06FL lens throw distance (m) = $H \times 0.8$: 0.8 m (min.) to 3.5 m (max.)

NP07ZL lens throw distance (m) = $H \times 1.4$ to $H \times 1.8$: 1.1 m (min.) to 19.9 m (max.)

NP08ZL lens throw distance (m) = $H \times 1.8$ to $H \times 2.4$: 1.5 m (min.) to 26.2 m (max.)

NP09ZL lens throw distance (m) = $H \times 2.3$ to $H \times 4.6$: 1.9 m (min.) to 49.9 m (max.)

NP10ZL lens throw distance (m) = $H \times 4.6$ to $H \times 8.6$: 3.8 m (min.) to 92.5 m (max.)

NP31ZL lens throw distance (m) = $H \times 0.8$ to $H \times 1.0$: 0.7 m (min.) to 10.9 m (max.)

"H" (Horizontal) refers to the screen width.

* Figures differ by several % with the table above because the calculation is approximate.

Projection range for the different lenses

[PX700W2]

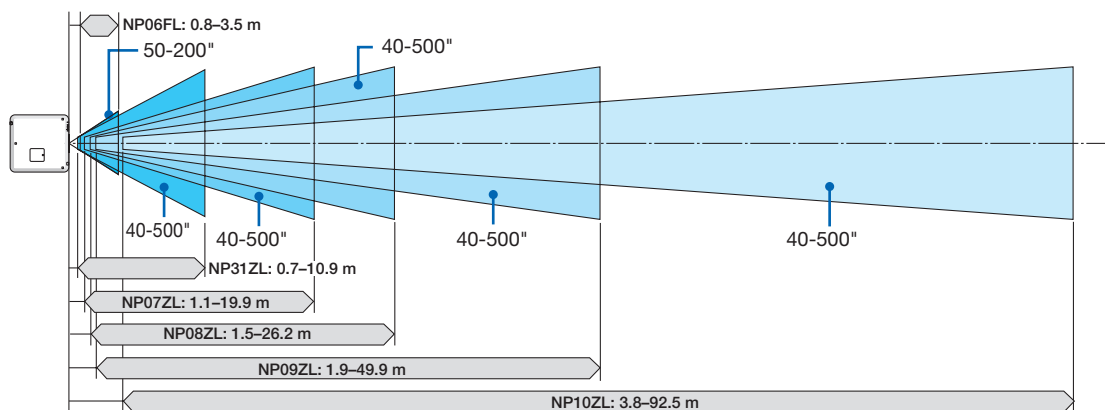

[PX800X2]

Screen size	Lens model name					
	NP06FL	NP07ZL	NP08ZL	NP09ZL	NP10ZL	NP31ZL
40"		1.1 – 1.4	1.4 – 1.9	1.8 – 3.6	3.5 – 6.8	0.6 – 0.8
50"	0.8	1.3 – 1.8	1.8 – 2.4	2.2 – 4.5	4.5 – 8.5	0.8 – 1.0
60"	0.9	1.6 – 2.2	2.2 – 2.9	2.7 – 5.5	5.4 – 10.2	0.9 – 1.2
80"	1.3	2.2 – 2.9	2.9 – 3.8	3.6 – 7.3	7.2 – 13.7	1.3 – 1.6
100"	1.6	2.7 – 3.7	3.6 – 4.8	4.6 – 9.2	9.0 – 17.2	1.6 – 2.0
120"	1.9	3.3 – 4.4	4.4 – 5.8	5.5 – 11.1	10.9 – 20.6	1.9 – 2.4
150"	2.4	4.1 – 5.5	5.5 – 7.3	6.9 – 13.8	13.6 – 25.8	2.4 – 3.0
200"	3.2	5.5 – 7.4	7.3 – 9.7	9.2 – 18.5	18.2 – 34.5	3.2 – 4.0
240"		6.6 – 8.9	8.8 – 11.7	11.1 – 22.2	21.9 – 41.4	3.9 – 4.9
300"		8.2 – 11.1	11.0 – 14.6	13.9 – 27.8	27.4 – 51.8	4.8 – 6.1
350"		9.6 – 13.0	12.9 – 17.0	16.2 – 32.5	32.0 – 60.4	5.7 – 7.1
400"		11.0 – 14.8	14.8 – 19.5	18.6 – 37.1	36.6 – 69.1	6.5 – 8.1
450"		12.4 – 16.7	16.6 – 21.9	20.9 – 41.8	41.2 – 77.7	7.3 – 9.1
500"		13.8 – 18.6	18.5 – 24.4	23.2 – 46.4	45.7 – 86.4	8.1 – 10.2

TIP

Calculation of the throw distance from the screen size

NP06FL lens throw distance (m) = $H \times 0.8$: 0.8 m (min.) to 3.2 m (max.)

NP07ZL lens throw distance (m) = $H \times 1.4$ to $H \times 1.8$: 1.1 m (min.) to 18.6 m (max.)

NP08ZL lens throw distance (m) = $H \times 1.8$ to $H \times 2.4$: 1.4 m (min.) to 24.4 m (max.)

NP09ZL lens throw distance (m) = $H \times 2.3$ to $H \times 4.6$: 1.8 m (min.) to 46.4 m (max.)

NP10ZL lens throw distance (m) = $H \times 4.5$ to $H \times 8.5$: 3.5 m (min.) to 86.4 m (max.)

NP31ZL lens throw distance (m) = $H \times 0.8$ to $H \times 1.0$: 0.6 m (min.) to 10.2 m (max.)

"H" (Horizontal) refers to the screen width.

* Figures differ by several % with the table above because the calculation is approximate.

Projection range for the different lenses

[PX800X2]

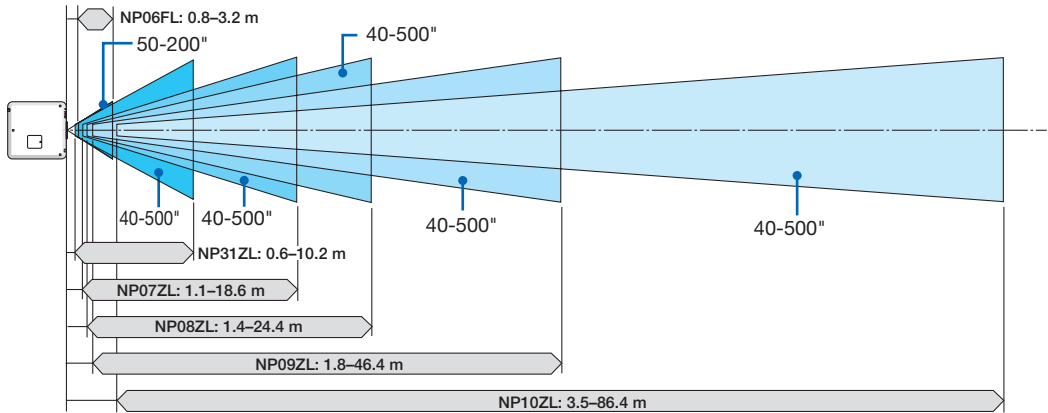

Lens shifting range

This projector is equipped with a lens shift function for adjusting the position of the projected image by using the LENS SHIFT $\blacktriangledown\blacktriangleleft\blacktriangleright$ buttons. The lens can be shifted within the range shown below.

Description of symbols: V indicates vertical (height of the projected image), H indicates horizontal (width of the projected image).

NOTE: The lens shift function cannot be used when using the NP16FL (PX750U2) and NP06FL (PX700W2/PX800X2) lens.

Desk/front projection

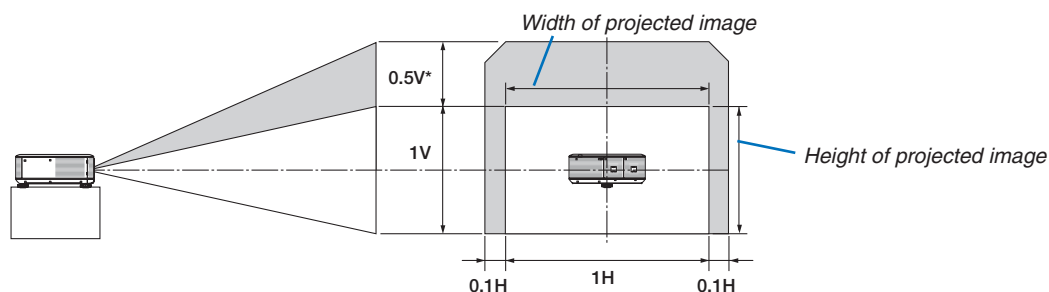

Ceiling/front projector

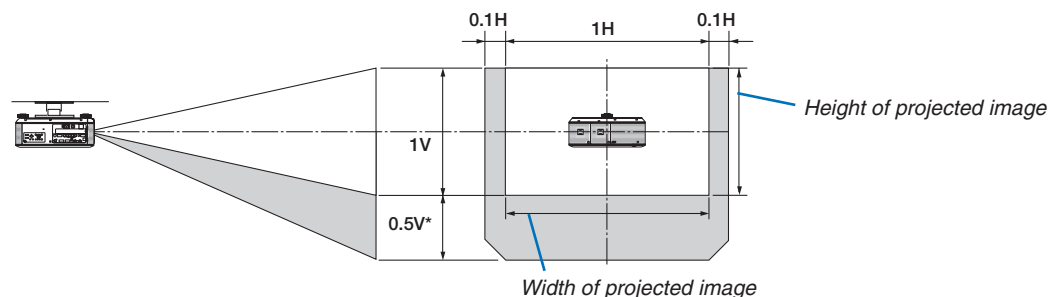

* For PX800X2, the value should be $0.43V$ on the NP31ZL lens.

Ex.: When using the PX750U2 to project on a 150" screen

According to the tables of screen sizes and dimensions for 16:10 (\rightarrow page 212), $H = 323.1$ cm, $V = 201.9$ cm.

Adjustment range in the vertical direction: The projected image can be moved upwards 0.5×201.9 cm ≈ 101 cm, (when the lens is at the center position). For a ceiling/front installation, the above figures are inverted.

Adjustment range in the horizontal direction: The projected image can be moved to the left 0.1×323.1 cm ≈ 32 cm, to the right 0.1×323.1 cm ≈ 32 cm.

* Figures differ by several % because the calculation is approximate.

② Replacing the Color Wheel (included)

The projector comes with a color wheel (6-segment White) installed. An additional color wheel (6-segment Color) is included with the accessories that come with the box.

TIP:

You can replace the pre-installed 6-segment White color wheel with the included 6-segment color wheel to create images with more brilliant colors to match the source.

To replace the color wheel, refer to the following guide.

CAUTION:

Before replacing the color wheel, be sure to turn off the projector, wait until the cooling fans stop, and turn off the main power switch. Allow 1 hour before replacing the color wheel.

- Do not touch the disk of the color wheel. Doing so may scratch the disk or leave fingerprints, causing the image quality to degrade.
- Do not remove screws except when specified in the following instructions
- Heed the following information if you own two or more projectors:

When replacing or re-installing the color wheel, the original color wheel preinstalled or supplied as an accessory must go back to its original projector. Your color wheel and projector color wheel cover are given an identification number. Be sure to use the color wheel pre-installed or supplied with your projector to match its identification number.

If you remove a color wheel from one projector and re-install it into another projector, performance may be compromised.

- Be sure turn off the main power switch before replacing the color wheel. Failure to do so may result in electrical shock or damage to the projector, and cause an irregular color of the projected image.

Tool needed: Phillips screwdriver (plus-head)

1. Remove the color wheel cover

- Loosen the screw on the color wheel cover.
 - The screw is captive and not removable.

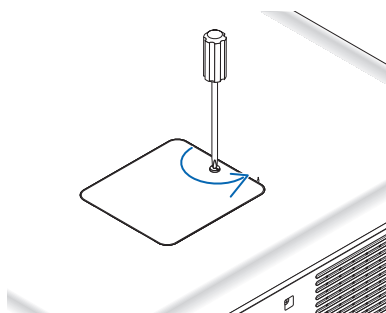

(shown from the rear side of the projector)

- Slide and remove the color wheel cover.

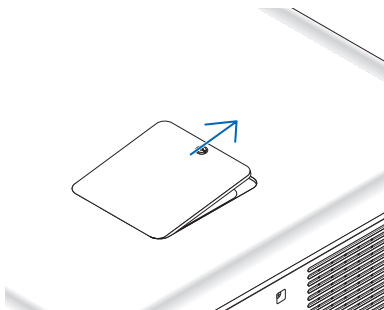

2. Remove the color wheel (6-segment white).

- Loosen the four screws on the color wheel.
- The screws are captive and not removable.

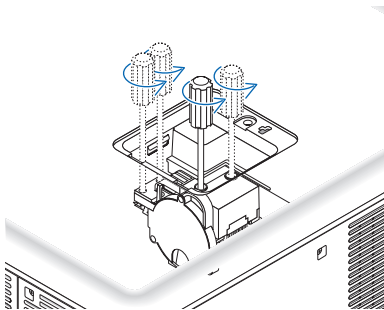

- Lift up the color wheel (6-segment white)

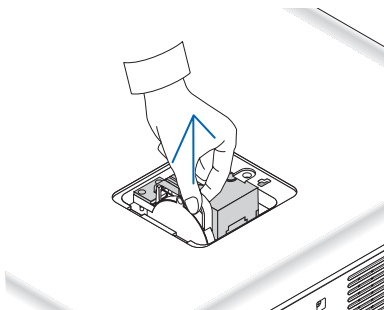

3. Install the supplied color wheel (6-segement color).

- Insert the supplied color wheel.

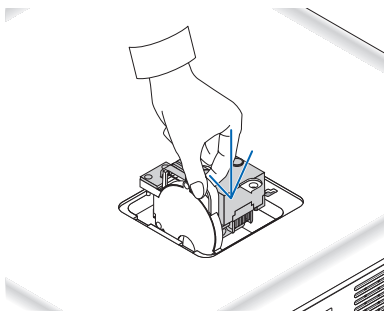

- Tighten the four screws to secure the color wheel.
- Be sure to tighten the screws.

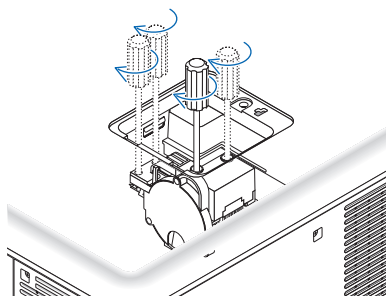

4. Replace the color wheel cover.

- Insert the two tabs of the color wheel into the two grooves of the cabinet.

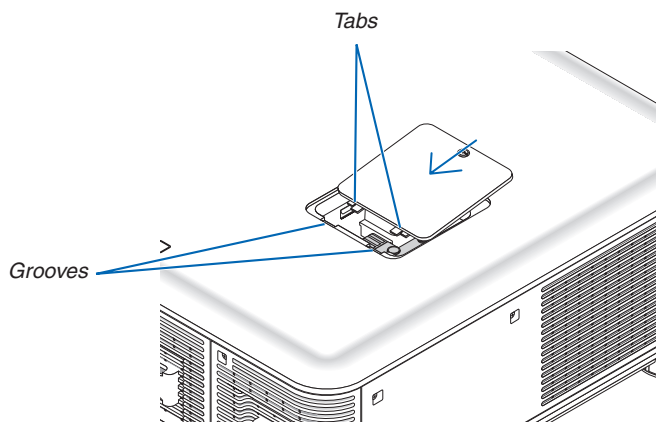

- Tighten the screw.
- Be sure to tighten the screw.

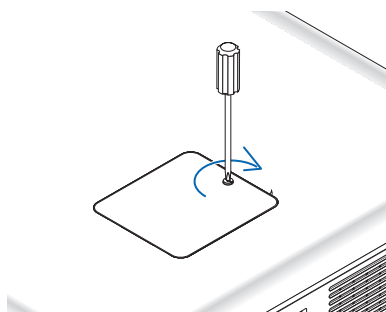

NOTE:

Improper (loose) installation of the color wheel prevents an image from being displayed.

Storing Unused Color Wheel:

Keep the unused color wheel in the zipper bag in which the supplied 6-segment color wheel was packaged. This bag prevents dust from falling or collecting on the color wheel.

3 Mounting the Optional Board (sold separately)

CAUTION

Before mounting or removing the optional board, be sure to turn off the projector, wait for the fans to stop and turn off the main power switch.

Tool needed: Phillips screwdriver (plus-head)

The SB-01HC board is used as an example.

1. Turn off the main power switch of the projector.

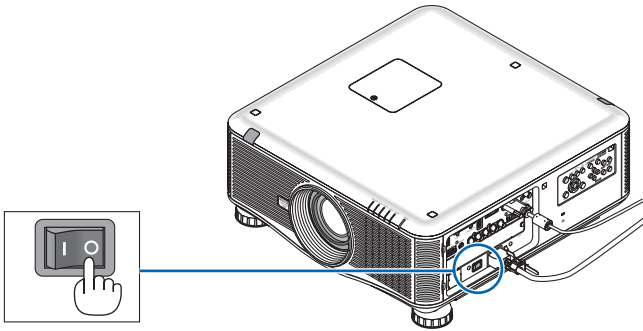

2. Loosen the two screws on the slot cover of the terminal panel.

Remove the two screws and the slot cover.

NOTE: Keep the two screws and the slot cover.

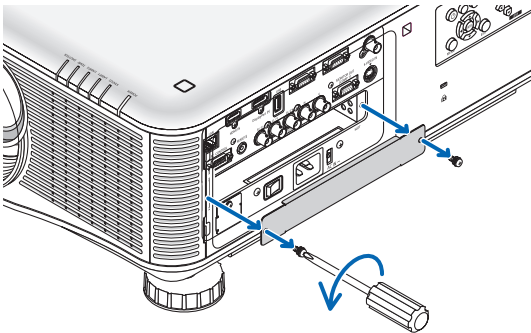

3. Insert the optional board into the slot.

Make sure that the board is inserted into the slot in the correct orientation.

Incorrect orientation may cause miscommunication between the optional board and projector.

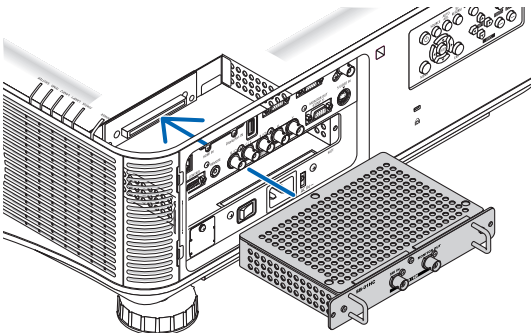

4. Tighten the two screws on both sides of the slot.

- Be sure to tighten the screws.

This will complete installation of the optional board.

Refer to the user's manual included with the board for source selection.

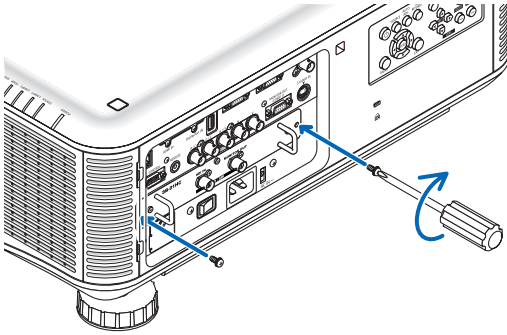

NOTE:

- Mounting the optional board may cause the fans to run in the standby mode for the purpose of cooling depending on the optional board. The fan speed may also increase in order to cool the projector properly. Both of these instances are considered normal and not a malfunction of the projector.
-

④ Compatible Input Signal List

Analog RGB

Signal	Resolution (dots)	Aspect Ratio	Refresh Rate (Hz)
VGA	640 × 480	4 : 3	60/72/75/85/iMac
SVGA	800 × 600	4 : 3	56/60/72/75/85/iMac
XGA	1024 × 768	4 : 3	60/70/75/85/iMac
XGA+	1152 × 864	4 : 3	60/70/75/85
WXGA	1280 × 768	15 : 9	60
	1280 × 800	16 : 10	60
	1360 × 768 *1	16 : 9	60
	1366 × 768 *1	16 : 9	60
Quad-VGA	1280 × 960	4 : 3	60/75/85
SXGA	1280 × 1024	5 : 4	60/75/85
SXGA+	1400 × 1050	4 : 3	60/75
WXGA+	1440 × 900	16 : 10	60
WXGA++	1600 × 900	16 : 9	60
UXGA	1600 × 1200	4 : 3	60/65/70/75
WSXGA+	1680 × 1050	16 : 10	60
WUXGA	1920 × 1200	16 : 10	60 (Reduced Blanking)
HD	1280 × 720	16 : 9	60
Full HD	1920 × 1080	16 : 9	60
MAC 13"	640 × 480	4 : 3	67
MAC 16"	832 × 624	4 : 3	75
MAC 19"	1024 × 768	4 : 3	75
MAC 21"	1152 × 870 *2	4 : 3	75
MAC 23"	1280 × 1024	5 : 4	65

HDMI

Signal	Resolution (dots)	Aspect Ratio	Refresh Rate (Hz)
VGA	640 × 480	4 : 3	60
SVGA	800 × 600	4 : 3	60
XGA	1024 × 768	4 : 3	60
HD	1280 × 720	16 : 9	60
WXGA	1280 × 768	15 : 9	60
	1280 × 800	16 : 10	60
	1366 × 768 *1	16 : 9	60
Quad-VGA	1280 × 960	4 : 3	60
SXGA	1280 × 1024	5 : 4	60
SXGA+	1400 × 1050	4 : 3	60
WXGA+	1440 × 900	16 : 10	60
WXGA++	1600 × 900	16 : 9	60
WSXGA+	1680 × 1050	16 : 10	60
UXGA	1600 × 1200	4 : 3	60
Full HD	1920 × 1080	16 : 9	60
WUXGA	1920 × 1200	16 : 10	60 (Reduced Blanking)
HDTV(1080p)	1920 × 1080	16 : 9	50/60
HDTV(1080i)	1920 × 1080	16 : 9	50/60
HDTV (720p)	1280 × 720	16 : 9	50/60
SDTV (480p)	720 × 480	4:3 / 16:9	60
SDTV (576p)	720 × 576	4:3 / 16:9	50
SDTV(480i)	1440 × 480	4:3 / 16:9	60
SDTV(576i)	1440 × 576	4:3 / 16:9	50

DisplayPort

Signal	Resolution (dots)	Aspect Ratio	Refresh Rate (Hz)
VGA	640 × 480	4 : 3	60
SVGA	800 × 600	4 : 3	60
XGA	1024 × 768	4 : 3	60
HD	1280 × 720	16 : 9	60
WXGA	1280 × 768	15 : 9	60
	1280 × 800	16 : 10	60
	1366 × 768 *1	16 : 9	60
Quad-VGA	1280 × 960	4 : 3	60
SXGA	1280 × 1024	5 : 4	60
SXGA+	1400 × 1050	4 : 3	60
WXGA+	1440 × 900	16 : 10	60
WXGA++	1600 × 900	16 : 9	60
WSXGA+	1680 × 1050	16 : 10	60
UXGA	1600 × 1200	4 : 3	60
Full HD	1920 × 1080	16 : 9	60
WUXGA	1920 × 1200	16 : 10	60 (Reduced Blanking)
HDTV(1080p)	1920 × 1080	16 : 9	50/60
HDTV (720p)	1280 × 720	16 : 9	50/60
SDTV (480p)	720 × 480	4:3 / 16:9	60
SDTV (576p)	720 × 576	4:3 / 16:9	50

Component

Signal	Resolution (dots)	Aspect Ratio	Refresh Rate (Hz)
HDTV(1080p)	1920 × 1080	16 : 9	50/60
HDTV(1080i)	1920 × 1080	16 : 9	50/60
HDTV (720p)	1280 × 720	16 : 9	50/60
SDTV (480p)	720 × 480	4:3 / 16:9	60
SDTV (576p)	720 × 576	4:3 / 16:9	50
SDTV(480i)	720 × 480	4:3 / 16:9	60
SDTV(576i)	720 × 576	4:3 / 16:9	50

Composite Video/S-Video

Signal	Aspect Ratio	Refresh Rate (Hz)
NTSC	4 : 3	60
PAL	4 : 3	50
PAL60	4 : 3	60
SECAM	4 : 3	50

*1 The projector may fail to display these signals correctly when [AUTO] is selected for [ASPECT RATIO] in the on-screen menu. The factory default is [AUTO] for [ASPECT RATIO]. To display these signals, select [16:9] for [ASPECT RATIO].

*2 The projector may fail to display these signals correctly when [AUTO] is selected for [ASPECT RATIO] in the on-screen menu. The factory default is [AUTO] for [ASPECT RATIO]. To display these signals, select [4:3] for [ASPECT RATIO].

- Signals exceeding the projector's resolution are handled with scaling technology.
- With scaling technology, the size of characters and ruled lines may be uneven and colors may be blurred.
- Upon shipment, the projector is set for signals with standard display resolutions and frequencies, but adjustments may be required depending on the type of computer.

5 Specifications

This section provides technical information about projector's performance.

Optical

Model Name	PX750U2/PX700W2/PX800X2	PX750UG2/PX700WG2/PX800XG2
Projection System	PX750U2/PX750UG2: Single DLP® chip (0.67", aspect ratio 16:10) PX700W2/PX700WG2: Single DLP® chip (0.65", aspect ratio 16:10) PX800X2/PX800XG2: Single DLP® chip (0.7", aspect ratio 4:3)	
Resolution*1	PX750U2/PX750UG2: 1920 × 1200 pixels (WUXGA) PX700W2/PX700WG2: 1280 × 800 pixels (WXGA) PX800X2/PX800XG2: 1024 × 768 pixels (XGA)	
Lens	Option(see page 226)	
	PX750U2/PX750UG2	PX700W2/PX700WG2/PX800X2/PX800XG2
	NP16FL	NP06FL
	NP17ZL	NP07ZL
	NP18ZL	NP08ZL
	NP19ZL	NP09ZL
	NP20ZL	NP10ZL
	NP21ZL	NP31ZL
	NP31ZL	
Power Lens Shift	PX750U2/PX750UG2: +0.5V, +/-0.1H (NP17ZL, NP18ZL, NP19ZL, NP20ZL, NP21ZL, NP31ZL) PX700W2/PX700WG2: +0.5V, +/-0.1H (NP07ZL, NP08ZL, NP09ZL, NP10ZL, NP31ZL) PX800X2/PX800XG2: +0.5V, +/-0.1H (NP17ZL, NP18ZL, NP19ZL, NP20ZL, NP21ZL) +0.43V, +/-0.1H (NP31ZL)	
Lamp	400W AC (320W in ECO)	
Light Output*2 *3	PX750U2/PX750UG2: 7,500 lumens PX700W2/PX700WG2: 7,000 lumens PX800X2/PX800XG2: 8,000 lumens ECO:80%	
Contrast Ratio*3 (full white: full black)	1000:1 (2100:1 with DYNAMIC CONTRAST ON)	
Image Size (Diagonal)	PX750U2/PX750UG2: 50 - 300" PX700W2/PX700WG2: 40 - 500" PX800X2/PX800XG2: 40 - 500"	
Projection Distance (Min.-Max.)	(depending on the lens → page 213, 214, 215)	

*1 Effective pixels are more than 99.99%.

*2 This is the light output value (lumens) when the [PRESET] mode is set to [HIGH-BRIGHT] and the pre-installed 6-segment White color wheel is used and when the optional lenses NP18ZL (for PX750U2) and NP08ZL (for PX700W2/PX800X2) are used. If any other mode is selected as the [PRESET] mode, the light output value may drop slightly.

*3 Compliance with ISO21118-2005

Electrical

Model Name	PX750U2	PX700W2	PX800X2	PX750UG2	PX700WG2	PX800XG2
Inputs	2 × RGB/Component (mini D-Sub 15P), 5 × BNC, 1 × HDMI Type A (HDMI® Connector) HDCP supported*4, 1 × DisplayPort(20pin connector) HDCP supported*4, 1 × S-Video (DIN 4P), 1 × Video (BNC) 1 × Option Slot					
Outputs	1 × RGB (D-Sub 15P)					
PC Control	1 × PC Control Port (D-Sub 9P)					
Wired Remote	1 × Stereo mini Jack					
Wired LAN Port	1 × RJ-45 (10BASE-T/100BASE-TX)					
Wireless LAN Port (Optional)	IEEE 802.11 b/g/n (optional Wireless LAN Unit [NP02LM Series] required)					
USB Port	1 × Type A					
Color Reproduction	10-bit signal processing (1.07 billion colors) (VIEWER, NETWORK: Colors, 16.7 million colors)					
Compatible Signals*5	Analog: VGA/SVGA/XGA/XGA+/WXGA/WXGA+/SXGA/SXGA+/UXGA/WUXGA/480i/480p/576i/576p/720p/1080i/1080p HDMI: VGA/SVGA/XGA/WXGA/SXGA/SXGA+/UXGA/WUXGA/480p/576p/720p/1080i/1080p (Refresh rate: 60 Hz only)					
Video Bandwidth	RGB: 165 MHz (Max.)					

Model Name			PX750U2	PX700W2	PX800X2	PX750UG2	PX700WG2	PX800XG2
Horizontal Resolution	540 TV lines: NTSC/NTSC4.43/PAL/PAL-M/PAL-N/PAL60 300 TV lines: SECAM							
Scan Rate	Horizontal: 15 kHz to 108 kHz (RGB: 24 kHz or over) Vertical: 48 Hz to 120 Hz (HDMI: 50 Hz to 85 Hz)							
Sync Compatibility	Separate Sync / Composite Sync / Sync on Green							
Power Requirement/Input Current	100-240V AC, 50/60 Hz, 10.8 - 4.3A							
Power Consumption	ECO MODE OFF (NORMAL)	Dual lamp	1006W (100-130V)/ 958W (200-240V)	969W (100-130V)/ 931W (200-240V)	963W (100-130V)/ 927W (200-240V)	958W (200-240V)	931W (200-240V)	927W (200-240V)
		Single lamp	530W (100-130V)/ 515W (200-240V)	506W (100-130V)/ 494W (200-240V)	500W (100-130V)/ 489W (200-240V)	515W (200-240V)	494W (200-240V)	489W (200-240V)
	ECO MODE ON	Dual lamp	810W (100-130V)/ 777W (200-240V)	778W (100-130V)/ 753W (200-240V)	777W (100-130V)/ 752W (200-240V)	777W (200-240V)	753W (200-240V)	752W (200-240V)
		Single lamp	439W (100-130V)/ 429W (200-240V)	413W (100-130V)/ 405W (200-240V)	412W (100-130V)/ 404W (200-240V)	429W (200-240V)	405W (200-240V)	404W (200-240V)
	STANDBY (NORMAL)		33W (100-130V)/ 34W (200-240V)	27W (100-130V)/ 27W (200-240V)	28W (100-130V)/ 28W (200-240V)	34W (200-240V)	27W (200-240V)	28W (200-240V)
	NORMAL2		23W (100-130V)/ 23W (200-240V)	17W (100-130V)/ 18W (200-240V)	19W (100-130V)/ 18W (200-240V)	23W (200-240V)	18W (200-240V)	
	STANDBY (POWER-SAVING)		0.2W (100-130V) 0.4W (200-240V)			0.4W (200-240V)		

*4 HDMI® (Deep Color, Lip Sync)/DisplayPort with HDCP

What is HDCP/HDCP technology?

HDCP is an acronym for High-bandwidth Digital Content Protection. High bandwidth Digital Content Protection (HDCP) is a system for preventing illegal copying of video data sent over a High-Definition Multimedia Interface (HDMI).

If you are unable to view material via the HDMI and DisplayPort input, this does not necessarily mean the projector is not functioning properly. With the implementation of HDCP, there may be cases in which certain content is protected with HDCP and might not be displayed due to the decision/intention of the HDCP community (Digital Content Protection, LLC).

Video: Deep Color; 8/10/12-bit, LipSync

Audio: LPCM; up to 2 ch, sample rate 32/44.1/48 KHz, sample bit; 16/20/24-bit

*5 An image with higher or lower resolution than the projector's native resolution (1920 × 1200) will be displayed with scaling technology.

Mechanical

Model Name	PX750U2/PX700W2/PX800X2	PX750UG2/PX700WG2/PX800XG2
Installation Orientation	Desktop/Front, Desktop/Rear, Ceiling/Front, Ceiling/Rear	
Dimensions	19.8" (W) × 7.6" (H) × 20.3" (D) /504 mm (W) × 192 mm (H) × 516 mm (D) (not including protrusions)	
Weight	43.4 lbs/19.7 kg (not including the lens)	
Environmental Considerations	Operational Temperatures: 32° to 104°F (0° to 40°C), Storage Temperatures: 14° to 122°F (-10° to 50°C), 20% to 80% humidity (non-condensing) Operating altitude: 0 to 2600 m/8500 feet (1600 to 2600 m/5500 to 8500 feet: Set [FAN MODE] to [HIGH ALUTITUDE])	
Regulations	<p>For United States: UL Approved (UL 60950-1) Meets FCC Class B requirements</p> <p>For Canada: UL Approved (CSA 60950-1) Meets DOC Canada Class B requirements</p> <p>For Australia/New Zealand: Meets AS/NZS CISPR.22 Class B</p> <p>For Europe: Meets EMC Directive (EN55022, EN55024, EN61000-3-2, EN61000-3-3) Meets Low Voltage Directive (EN60950-1, TÜV GS Approved)</p> 	

For additional information visit:

US : <http://www.necdisplay.com/>

Europe : <http://www.nec-display-solutions.com/>

Global : <http://www.nec-display.com/global/index.html>

For information on our optional accessories, visit our website or see our brochure.

The specifications are subject to change without notice.

Option lens

[PX750U2]

NP16FL	Power focus
	throw ratio 0.76:1, F1.85, f = 11.6 mm
	Image Size (Diagonal): 50–300 inches / 1.27–7.62 m Projection Distance (Min.–Max.): 0.81–5.08 m
NP17ZL	Power zoom and focus
	throw ratio 1.25–1.79:1, F1.85–2.5, f = 18.7–26.5 mm
	Image Size (Diagonal): 50–300 inches / 1.27–7.62 m Projection Distance (Min.–Max.): 1.33–11.74 m
NP18ZL	Power zoom and focus
	throw ratio 1.73–2.27:1, F1.64–1.86, f = 25.7–33.7 mm
	Image Size (Diagonal): 50–300 inches / 1.27–7.62 m Projection Distance (Min.–Max.): 1.83–14.88 m
NP19ZL	Power zoom and focus
	throw ratio 2.22–3.67:1, F1.86–2.48, f = 32.91–54.23 mm
	Image Size (Diagonal): 50–300 inches / 1.27–7.62 m Projection Distance (Min.–Max.): 2.36–24.13 m
NP20ZL	Power zoom and focus
	throw ratio 3.6–5.4:1, F1.85–2.41, f = 52.8–79.1 mm
	Image Size (Diagonal): 50–300 inches / 1.27–7.62 m Projection Distance (Min.–Max.): 3.80–35.36 m
NP21ZL	Power zoom and focus
	throw ratio 5.3–8.3:1, F1.85–2.48, f = 78.5–121.9 mm
	Image Size (Diagonal): 50–300 inches / 1.27–7.62 m Projection Distance (Min.–Max.): 5.60–54.81 m
NP31ZL	Power zoom and focus
	throw ratio 0.75–0.93:1, F1.96–2.3, f = 11.3–14.1 mm
	Image Size (Diagonal): 40–500 inches / 1.02–12.7 m Projection Distance (Min.–Max.): 0.62–10.41 m

[PX700W2/PX800X2]

NP06FL	Power focus
	throw ratio 0.77:1, F2.0, f = 11.4 mm
	Image Size (Diagonal): 50–200 inches / 1.27–5.08m Projection Distance (Min.–Max.): 0.84–3.48 m (PX700W2) / 0.78–3.24 m (PX800X2)
NP07ZL	Power zoom and focus
	throw ratio 1.33–1.79:1, F1.8–2.3, f = 19.3–25.8 mm
	Image Size (Diagonal): 40–500 inches / 1.02–12.7m Projection Distance (Min.–Max.): 1.14–19.92 m (PX700W2) / 1.06–18.56 m (PX800X2)
NP08ZL	Power zoom and focus
	throw ratio 1.78–2.35:1, F1.7–1.9, f = 26–34 mm
	Image Size (Diagonal): 40–500 inches / 1.02–12.7m Projection Distance (Min.–Max.): 1.53–26.16 m (PX700W2) / 1.42–24.35 m (PX800X2)
NP09ZL	Power zoom and focus
	throw ratio 2.22–4.43:1, F2.1–2.9, f = 32–63 mm
	Image Size (Diagonal): 40–500 inches / 1.02–12.7m Projection Distance (Min.–Max.): 1.90–49.85 m (PX700W2) / 1.76–46.42 m (PX800X2)
NP10ZL	Power zoom and focus
	throw ratio 4.43–8.3:1, F2.2–3.1, f = 63.5–117.4 mm
	Image Size (Diagonal): 40–500 inches / 1.02–12.7m Projection Distance (Min.–Max.): 3.81–92.53 m (PX700W2) / 3.54–86.36 m (PX800X2)
NP31ZL	Power zoom and focus
	throw ratio 0.79–0.98:1, F1.96–2.3, f = 11.3–14.1 mm
	Image Size (Diagonal): 40–500 inches / 1.02–12.7m Projection Distance (Min.–Max.): 0.66–10.91 m (PX700W2) / 0.61–10.16 m (PX800X2)

- These specifications and the product's design are subject to change without notice.

6 Cabinet Dimensions

Unit: mm (inch)

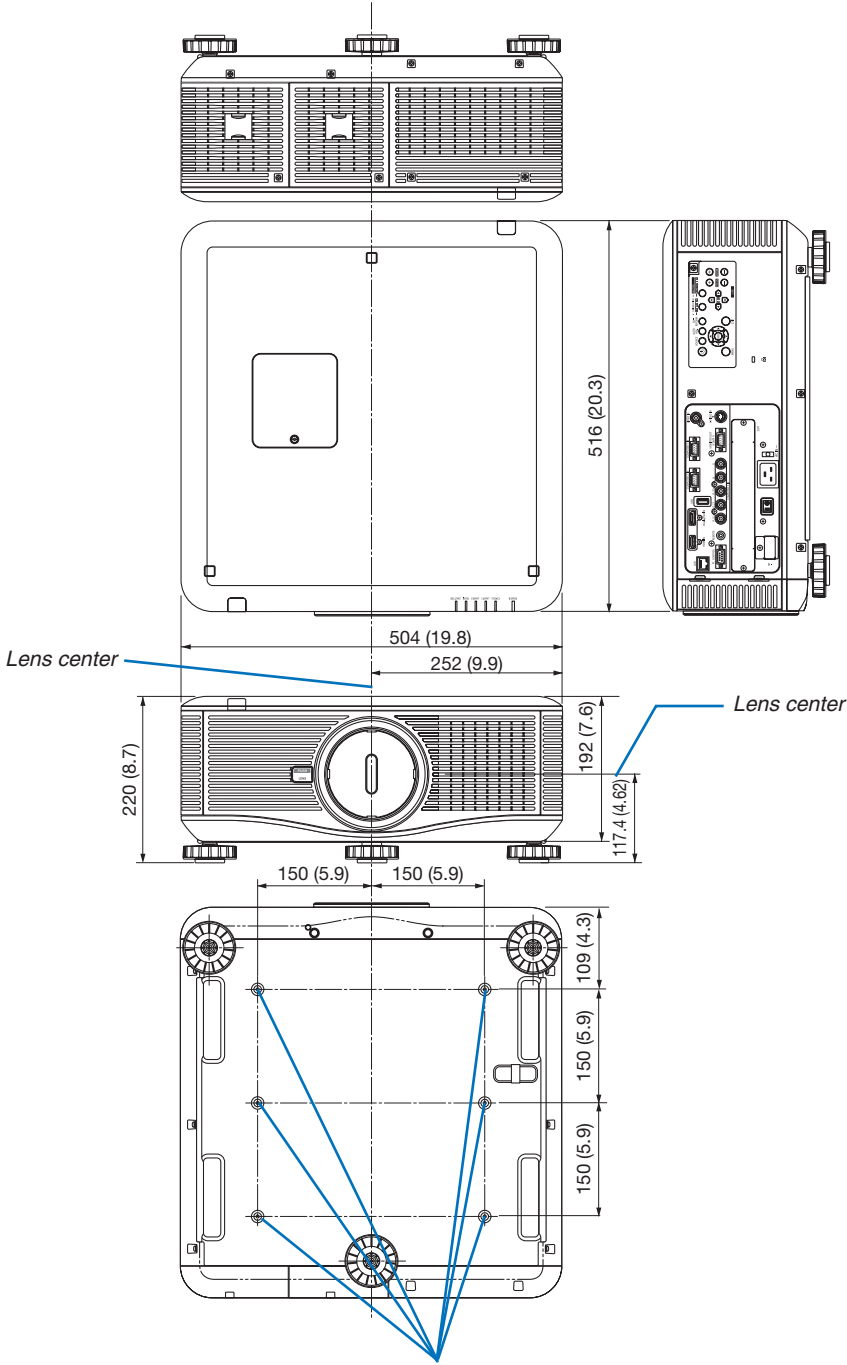

7 Pin Assignments of D-Sub COMPUTER Input Connector

Mini D-Sub 15 Pin Connector

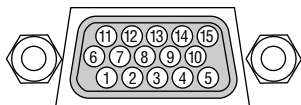

Signal Level

Video signal : 0.7Vp-p (Analog)

Sync signal : TTL level

Pin No.	RGB Signal (Analog)	YCbCr Signal
1	Red	Cr
2	Green or Sync on Green	Y
3	Blue	Cb
4	Ground	
5	Ground	
6	Red Ground	Cr Ground
7	Green Ground	Y Ground
8	Blue Ground	Cb Ground
9	No Connection	
10	Sync Signal Ground	
11	No Connection	
12	Bi-directional DATA (SDA)	
13	Horizontal Sync or Composite Sync	
14	Vertical Sync	
15	Data Clock	

8 Troubleshooting

This section helps you resolve problems you may encounter while setting up or using the projector.

Indicator Messages

POWER Indicator

Indicator display		Projector status	Procedure
Off		Power is off.	–
Flashing	Blue (short flashes)	Preparing to turn power on	Wait a while.
	Blue (long flashes)	Off timer (enabled) Program timer (off time enabled)	–
	Orange (short flashes)	Projector cooling	Wait a while.
	Orange (long flashes)	Program timer (on time enabled)	
Lit	Blue	Power on	–
	Orange	Standby mode (NORMAL or NORMAL2)	–
	Red	Standby mode (POWER-SAVING)	–

STATUS Indicator

Indicator display		Projector status	Procedure
Off		No problem, or standby mode (POWER-SAVING or NORMAL2)	–
Flashing	Red (cycles of 1)	Cover problem	The lamp cover is not properly mounted. Mount it properly. (→ Page 184)
	Red (cycles of 4)	Fan problem	The cooling fan has stopped turning. Contact an NEC projector customer support center for repairs.
Flashing	Orange	Network conflict	It is not possible to connect the projector's built-in LAN and wireless LAN simultaneously to the same network. To connect the projector's built-in LAN and wireless LAN simultaneously, connect them to different networks.
Lit	Green	Standby mode (NORMAL)	–
	Orange	Button has been pressed while projector is in key lock mode	The projector's keys are locked. The setting must be canceled to operate the projector. (→ Page 126)
		Projector's ID number and remote control's ID number do not match	Check the control IDs. (→ Pages 126 and 127)

LAMP 1/LAMP 2 Indicator

Indicator display		Projector status	Procedure
Off		The lamp is turned off.	–
Flashing	Green	Preparing to relight lamp after lighting has failed	Wait a while.
	Red	Lamp replacement grace period	The lamp has reached the end of its service life and is now in the replacement grace period (100 hours). Replace the lamp as soon as possible. (→ page 182)
	Red (cycles of 6)	Lamp does not light	The lamp has not turned on. Wait at least 1 minute, then turn the power back on. If the lamp still does not light, contact an NEC projector customer support center.
Lit	Red	Lamp usage time exceeded	The lamp has exceeded its usage time. The projector's power cannot be turned on until the lamp is replaced. (→ page 182)
	Green	Lamp lit	–

TEMP. Indicator

Indicator display		Projector status	Procedure
Off		No problem	
Flashing	Red	Temperature problem	The temperature protector has been activated. If the room temperature is high, move the projector to a cool place. If the TEMP. indicator still be flashing when the projector is used at operating temperatures, contact an NEC projector customer support center.
	Orange	Warming up	The usage environment temperature is lower than the projector's operating temperature (0°C). In that case, raise the usage environment temperature to a 0°C or higher and turn on the projector. If the projector is turned on at around 0°C, it may take 5 minutes to warm up the projector. During this warm-up period the TEMP. indicator will flash. When the warm-up is completed, the TEMP. indicator will go off.

SHUTTER Indicator

Indicator display		Projector status	Procedure
Off		Light	–
Flashing	Green	Lens calibration is in process.	–
On	Green	Light shuttered	–

If the temperature protector is activated

If the projector's internal temperature rises abnormally, the lamp turns off and the temperature indicator flashes (repeatedly in cycles of 2).

It may happen that the projector's temperature protector is simultaneously activated and the projector's power turns off.

If this happens, do the following:

- Unplug the power cord from the power outlet.
- If using in a place where the surrounding temperature is high, move the projector to a different, cool place.
- If there is dust in the ventilation holes, clean. (→ pages 179 and 181)
- Wait as such about 1 hour for the projector's internal temperature to lower.

Common Problems & Solutions

(→ “Power/Status/Lamp Indicator” on page 229.)

Problem	Check These Items
Does not turn on or shut down	<ul style="list-style-type: none"> • Check that the power cord is plugged in and that the power button on the projector cabinet or the remote control is on. (→ pages 14, 17, 18) • Ensure that the lamp cover is installed correctly. (→ page 184) • Check to see if the projector has overheated. If there is insufficient ventilation around the projector or if the room where you are presenting is particularly warm, move the projector to a cooler location. • Check to see if you continue to use the projector for another 100 hours after the lamp has reached the end of its life. If so, replace the lamp. After replacing the lamp, reset the lamp hours used. (→ page 137) • The lamp may fail to light. Wait a full minute and then turn on the power again. • Set [FAN MODE] to [HIGH ALTITUDE] when using the projector at altitudes approximately 5500 feet/1600 meters or higher. Using the projector at altitudes approximately 5500 feet/1600 meters or higher without setting to [HIGH ALTITUDE] can cause the projector to overheat and the projector could shut down. If this happens, wait a couple minutes and turn on the projector. (→ page 128) <p>If you turn on the projector immediately after the lamp is turned off, the fans run without displaying an image for some time and then the projector will display the image. Wait for a moment.</p>
Will turn off	<ul style="list-style-type: none"> • Ensure that the [OFF TIMER], [AUTO POWER OFF] or [PROGRAM TIMER] is off. (→ page 120, 131)
No picture	<ul style="list-style-type: none"> • Check if the appropriate input is selected. (→ page 21) If there is still no picture, press the SOURCE button or one of the input buttons again. • Ensure your cables are connected properly. • Use menus to adjust the brightness and contrast. (→ page 110) • Ensure that the lens cover is open. (→ page 17) • Reset the settings or adjustments to factory preset levels using the [RESET] in the Menu. (→ page 137) • Enter your registered keyword if the Security function is enabled. (→ page 44) • If the HDMI input or the DisplayPort signal cannot be displayed, try the following. <ul style="list-style-type: none"> - Reinstall your driver for the graphics card built in your computer, or use the updated driver. For reinstalling or updating your driver, refer to the user guide accompanied with your computer or graphics card, or contact the support center for your computer manufacturer. Install the updated driver or OS on your own responsibility. We are not liable for any trouble and failure caused by this installation. • Be sure to connect the projector and notebook PC while the projector is in standby mode and before turning on the power to the notebook PC. In most cases the output signal from the notebook PC is not turned on unless connected to the projector before being powered up. <ul style="list-style-type: none"> * If the screen goes blank while using your remote control, it may be the result of the computer's screen-saver or power management software. • See also the page 233.
Color tone or hue is unusual	<ul style="list-style-type: none"> • Check if an appropriate color is selected in [WALL COLOR]. If so, select an appropriate option. (→ page 118) • Adjust [HUE] in [PICTURE]. (→ page 110)
Image isn't square to the screen	<ul style="list-style-type: none"> • Reposition the projector to improve its angle to the screen. (→ page 22) • Use the Keystone correction function to correct the trapezoid distortion. (→ page 30)
Picture is blurred	<ul style="list-style-type: none"> • Adjust the focus. (→ page 25) • Reposition the projector to improve its angle to the screen. (→ page 22) • Ensure that the distance between the projector and screen is within the adjustment range of the lens. (→ page 213, 214, 215) • Has the lens been shifted by an amount exceeding the guaranteed range? (→ page 216) • Condensation may form on the lens if the projector is cold, brought into a warm place and is then turned on. Should this happen, let the projector stand until there is no condensation on the lens.
Flicker appears on screen	<ul style="list-style-type: none"> • Set [FAN MODE] to other than [HIGH ALTITUDE] mode when using the projector at altitudes approximately 5500 feet/1600 meters or lower. Using the projector at altitudes less than approximately 5500 feet/1600 meters and setting to [HIGH ALTITUDE] can cause the lamp to overcool, causing the image to flicker. Switch [FAN MODE] to [AUTO]. (→ page 128)
Image is scrolling vertically, horizontally or both	<ul style="list-style-type: none"> • Check the computer's resolution and frequency. Make sure that the resolution you are trying to display is supported by the projector. (→ page 222) • Adjust the computer image manually with the Horizontal/Vertical in the [IMAGE OPTIONS]. (→ page 112)

Remote control does not work	<ul style="list-style-type: none"> • Install new batteries. (→ page 9) • Make sure there are no obstacles between you and the projector. • Stand within 22 feet (7 m) of the projector. (→ page 9) • If the remote control cable plug is inserted into the REMOTE jack, the remote control does not function wirelessly. (→ page 10) • Make sure that the remote control's ID corresponds with the projector's ID. (→ page 126, 127)
Indicator is lit or blinking	<ul style="list-style-type: none"> • See the POWER/STATUS/LAMP Indicator. (→ page 229)
Cross color in RGB mode	<ul style="list-style-type: none"> • Press the AUTO ADJ. button on the projector cabinet or the remote control. (→ page 32) • Adjust the computer image manually with [CLOCK]/[PHASE] in [IMAGE OPTIONS] in the menu. (→ page 111)
No on-screen display	<ul style="list-style-type: none"> • Check if the on-screen mute is turned on. To turn off the on-screen mute, press the ON-SCREEN button on the remote control or hold down the MENU button on the projector cabinet for at least 10 seconds. (→ page 35)

For more information contact your dealer.

If there is no picture, or the picture is not displayed correctly.

- Power on process for the projector and the PC.

Be sure to connect the projector and notebook PC while the projector is in standby mode and before turning on the power to the notebook PC.

In most cases the output signal from the notebook PC is not turned on unless connected to the projector before being powered up.

NOTE: You can check the horizontal frequency of the current signal in the projector's menu under Information. If it reads "0kHz", this means there is no signal being output from the computer. (→ page 134 or go to next step)

- Enabling the computer's external display.

Displaying an image on the notebook PC's screen does not necessarily mean it outputs a signal to the projector. When using a PC compatible laptop, a combination of function keys will enable/disable the external display. Usually, the combination of the "Fn" key along with one of the 12 function keys gets the external display to come on or off. For example, NEC laptops use Fn + F3, while Dell laptops use Fn + F8 key combinations to toggle through external display selections.

- Non-standard signal output from the computer

If the output signal from a notebook PC is not an industry standard, the projected image may not be displayed correctly. Should this happen, deactivate the notebook PC's LCD screen when the projector display is in use. Each notebook PC has a different way of deactivate/reactivate the local LCD screens as described in the previous step. Refer to your computer's documentation for detailed information.

- Image displayed is incorrect when using a Macintosh

When using a Macintosh with the projector, set the DIPswitch of the Mac adapter (not supplied with the projector) according to your resolution. After setting, restart your Macintosh for the changes to take affect.

For setting display modes other than those supported by your Macintosh and the projector, changing the DIP switch on a Mac adapter may bounce an image slightly or may display nothing. Should this happen, set the DIP switch to the 13" fixed mode and then restart your Macintosh. After that, restore the DIP switches to a displayable mode and then restart the Macintosh again.

NOTE: A Video Adapter cable manufactured by Apple Computer is needed for a PowerBook which does not have a mini D-Sub 15-pin connector.

- Mirroring on a PowerBook

* When using the projector with a Macintosh PowerBook, output may not be set to 1024 × 768 unless "mirroring" is off on your PowerBook. Refer to owner's manual supplied with your Macintosh computer for mirroring.

- Folders or icons are hidden on the Macintosh screen

Folders or icons may not be seen on the screen. Should this happen, select [View] → [Arrange] from the Apple menu and arrange icons.

9 PC Control Codes and Cable Connection

PC Control Codes

Function	Code Data								
POWER ON	02H	00H	00H	00H	00H	02H			
POWER OFF	02H	01H	00H	00H	00H	03H			
INPUT SELECT COMPUTER 1	02H	03H	00H	00H	02H	01H	01H	09H	
INPUT SELECT COMPUTER 2	02H	03H	00H	00H	02H	01H	02H	0AH	
INPUT SELECT COMPUTER 3	02H	03H	00H	00H	02H	01H	03H	0BH	
INPUT SELECT HDMI	02H	03H	00H	00H	02H	01H	1AH	22H	
INPUT SELECT DisplayPort	02H	03H	00H	00H	02H	01H	1BH	23H	
INPUT SELECT VIDEO	02H	03H	00H	00H	02H	01H	06H	0EH	
INPUT SELECT S-VIDEO	02H	03H	00H	00H	02H	01H	0BH	13H	
INPUT SELECT VIEWER	02H	03H	00H	00H	02H	01H	1FH	27H	
INPUT SELECT NETWORK	02H	03H	00H	00H	02H	01H	20H	28H	
PICTURE MUTE ON	02H	10H	00H	00H	00H	12H			
PICTURE MUTE OFF	02H	11H	00H	00H	00H	13H			

NOTE: Contact your local dealer for a full list of the PC Control Codes if needed.

Cable Connection

Communication Protocol

Baud rate 38400 bps

Data length 8 bits

Parity No parity

Stop bit One bit

X on/off None

Communications procedure Full duplex

NOTE: Depending on the equipment, a lower baud rate may be recommended for long cable runs.

PC Control Connector (D-SUB 9P)

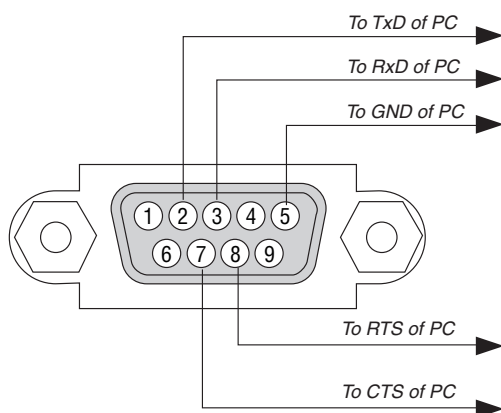

NOTE 1: Pins 1, 4, 6 and 9 are no used.

NOTE 2: Jumper "Request to Send" and "Clear to Send" together on both ends of the cable to simplify cable connection.

NOTE 3: For long cable runs it is recommended to set communication speed within projector menus to 9600 bps.

10 Troubleshooting Check List

Before contacting your dealer or service personnel, check the following list to be sure repairs are needed also by referring to the “Troubleshooting” section in your user’s manual. This checklist below will help us solve your problem more efficiently.

* Print this page and the next page for your check.

Frequency of occurrence always sometimes (How often? _____) other (_____)

Power

- No power (POWER indicator does not light blue) See also “Status Indicator (STATUS)”.
 - Power cord’s plug is fully inserted into the wall outlet.
 - Main power switch is pressed to the ON position.
 - Lamp cover is installed correctly.
 - Lamp Hours Used (lamp operation hours) was cleared after lamp replacement.
 - No power even though you press and hold the POWER button for 1 second.
- Shut down during operation.
 - Power cord’s plug is fully inserted into the wall outlet.
 - Lamp cover is installed correctly.
 - [AUTO POWER OFF] is turned off (only models with the [AUTO POWER OFF] function).
 - [OFF TIMER] is turned off (only models with the [OFF TIMER] function).

Video and Audio

- No image is displayed from your PC or video equipment to the projector.
 - Still no image even though you connect the projector to the PC first, then start the PC.
 - Enabling your notebook PC’s signal output to the projector.
 - *A combination of function keys will enable/disable the external display. Usually, the combination of the “Fn” key along with one of the 12 function keys turns the external display on or off.*
 - No image (blue or black background, no display).
 - Still no image even though you press the AUTO ADJUST button.
 - Still no image even though you carry out [RESET] in the projector’s menu.
 - Signal cable’s plug is fully inserted into the input connector
 - A message appears on the screen.
(_____)
 - The source connected to the projector is active and available.
 - Still no image even though you adjust the brightness and/or the contrast.
 - Input source’s resolution and frequency are supported by the projector.
- Image is too dark.
 - Remains unchanged even though you adjust the brightness and/or the contrast.
- Image is distorted.
 - Image appears to be trapezoidal (unchanged even though you carry out the [KEYSTONE] adjustment).
- Parts of the image are lost.
 - Still unchanged even though you press the AUTO ADJUST button.
 - Still unchanged even though you carry out [RESET] in the projector’s menu.
- Image is shifted in the vertical or horizontal direction.
 - Horizontal and vertical positions are correctly adjusted on a computer signal.
 - Input source’s resolution and frequency are supported by the projector.
 - Some pixels are lost.
- Image is flickering.
 - Still unchanged even though you press the AUTO ADJUST button.
 - Still unchanged even though you carry out [RESET] in the projector’s menu.
 - Image shows flickering or color drift on a computer signal.
 - Still unchanged even though you change [FAN MODE] from [HIGH ALTITUDE] to [AUTO].
- Image appears blurry or out of focus.
 - Still unchanged even though you checked the signal’s resolution on PC and changed it to projector’s native resolution.
 - Still unchanged even though you adjusted the focus.

Other

- Remote control does not work.
 - No obstacles between the sensor of the projector and the remote control.
 - Projector is placed near a fluorescent light that can disturb the infrared remote controls.
 - Batteries are new and are not reversed in installation.
- Buttons on the projector cabinet do not work (only models with the [CONTROL PANEL LOCK] function)
 - [CONTROL PANEL LOCK] is not turned on or is disabled in the menu.
 - Still unchanged even though you press and hold the EXIT button for a minimum of 10 seconds.

In the space below please describe your problem in detail.

Information on application and environment where your projector is used

Projector

Model number:
 Serial No.:
 Date of purchase:
 Lamp operating time (hours):
 Eco Mode: OFF ON
 Information on input signal:
 Horizontal synch frequency [] kHz
 Vertical synch frequency [] Hz
 Synch polarity H (+) (-)
 V (+) (-)
 Synch type Separate Composite
 Sync on Green
 STATUS Indicator:
 Steady light Orange Green
 Flashing light [] cycles
 Remote control model number:

Installation environment

Screen size: inch
 Screen type: White matte Beads Polarization
 Wide angle High contrast
 Throw distance: feet/inch/m
 Orientation: Ceiling mount Desktop
 Power outlet connection:
 Connected directly to wall outlet
 Connected to power cord extender or other (the number of connected equipment _____)
 Connected to a power cord reel or other (the number of connected equipment _____)

Computer

Manufacturer:
 Model number:
 Notebook PC / Desktop
 Native resolution:
 Refresh rate:
 Video adapter:
 Other:

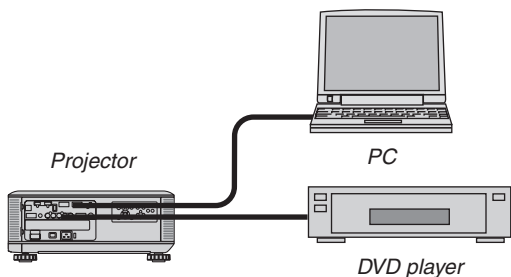

Signal cable

NEC standard or other manufacturer's cable?
 Model number: Length: inch/m
 Distribution amplifier
 Model number:
 Switcher
 Model number:
 Adapter
 Model number:

Video equipment

VCR, DVD player, Video camera, Video game or other
 Manufacturer:
 Model number:

① REGISTER YOUR PROJECTOR! (for residents in the United States, Canada, and Mexico)

Please take time to register your new projector. This will activate your limited parts and labor warranty and InstaCare service program.

Visit our web site at www.necdisplay.com, click on support center/register product and submit your completed form online. Upon receipt, we will send a confirmation letter with all the details you will need to take advantage of fast, reliable warranty and service programs from the industry leader, NEC Display Solutions of America, Inc.

NEC