

Installation and Maintenance manual

LED Module/LED DISPLAY [Models for indoor use]	LED Display Kit [Models for indoor use]	LED Display Kit [Models for indoor use]
LED-E012i	LED-E012i-108	LED-E012i-10N
LED-E015i	LED-E015i-135	LED-E015i-13N
LED-E018i	LED-E018i-162	LED-E018i-16N
LED-E025i	LED-E012i-217	LED-E012i-21N
	LED-E025i-217	LED-E025i-21N

MODEL: LED-E012i, LED-E015i, LED-E018i, LED-E025i

Table of Contents

Important Information	English-1
Parts Name	English-5
Model name list	English-6
Contents	English-7
Installation Example	English-10
1. Installation location.....	10
2. Mark the positions of the anchor points on the wall	12
3. Make the holes at the anchor positions	13
4. Install the mounting bars.....	14
5. Install the power bar	16
6. Install the cabinet hanger pins to the back of the cabinets.....	17
7. Install the cabinets	19
8. Assembly diagrams	27
9. Installation without a frame set	29
10. Wiring	30
11. Installing the pixel card.....	35
Screen Configuration	English-36
Image Setting	English-47
Cleaning	English-54
Maintenance	English-55
Troubleshooting	English-59
1. Display problems	59
2. Adjusting the colors on a part of the screen.....	60
3. State monitoring using the software	66
4. Redundancy setting method	71
Specifications	English-89
Diagram	English-91

- NOTE:** (1) The contents of this manual may not be reprinted in part or whole without permission.
(2) The contents of this manual are subject to change without notice.
(3) Great care has been taken in the preparation of this manual; however, should you notice any questionable points, errors or omissions, please contact us.
(4) The image shown in this manual is indicative only. If there is inconsistency between the image and the actual product, the actual product shall govern.
(5) Notwithstanding articles (3) and (4), we will not be responsible for any claims on loss of profit or other matters deemed to result from using this device.

The company names and product names mentioned in this manual are trademarks or registered trademarks of respective companies.



Important Information

Safety Precautions and Maintenance



FOR OPTIMUM PERFORMANCE, PLEASE NOTE
THE FOLLOWING WHEN SETTING UP AND
USING THE LED DISPLAY SYSTEM:

About the Symbols

To ensure safe and proper use of the product, this manual uses a number of symbols to prevent injury to you and others as well as damage to property. The symbols and their meanings are described below. Be sure to understand them thoroughly before reading this manual.

















 WARNING	Failing to heed this symbol and handling the product incorrectly could result in accidents leading to major injury or death.
 CAUTION	Failing to heed this symbol and handling the product incorrectly could result in personal injury or damage to surrounding property.

Examples of symbols









	⚠ Indicates a warning or caution. This symbol indicates you should be careful of electric shocks.
	⊘ Indicates a prohibited action. This symbol indicates something that must be prohibited.
	● Indicates a mandatory action. This symbol indicates that the power cord should be unplugged from the power outlet.

- Be sure to read the following before using the product to use it correctly and safely.

WARNING

-  Do not apply vibrations or shocks to the product.
-  Do not install the product to unstable locations or locations subject to vibrations.
-  Always ask a technician to perform the installation.
-  Do not connect the cables with wet hands. Otherwise, it may cause an injury or an electrical shock.
-  Do not repair or modify the product yourself. Otherwise, it may cause an injury, a fire or an electrical shock.
-  In case of thunder, do not touch the power cord. Otherwise, it may cause an electrical shock.
-  Connect the product to the correct voltage. If the product is connected to a voltage other than the specified voltage, it may lead to a fire or an electrical shock.
-  In case of a malfunction (nothing is displayed on the screen, etc.) or if smoke, abnormal heat, or a strange sound or odor is generated, turn the power off and immediately ask a technician or your retailer for repair.
-  Install the product so that the vents are not obstructed.
-  Make sure there are enough people available to ensure safety (at least two people) when installing or moving the product. Otherwise, it may lead to an injury.
-  Be sure to ground the product. If the product is not grounded, there is a risk of electrical shock in case a malfunction occurs.
-  In case foreign matter has entered into the product, immediately disconnect the power supply and stop using the product.
-  After the installation, if a problem such as loose screws occurs, immediately ask a technician or your retailer for repair.
-  Do not put objects into the product. Otherwise, it may cause a fire or an electrical shock.
-  In case the product is in contact with water or another liquid, immediately disconnect the power supply and stop using the product. If you continue using the product in that state, it may lead to a malfunction, a fire, or an electrical shock.
-  When using the power connector (WAGO), do not use it outdoors or in a humid environment. Otherwise, it may cause a fire or an electrical shock.

CAUTION

-  When connecting the power cord to the product's AC IN terminal, make sure the connector is fully and firmly inserted.
-  Do not damage the power cord. Do not put heavy objects on it, place it near heaters, pull it with excessive strength, or apply a strong force on it while it is bent. A damaged power cord may cause a fire or an electrical shock.
-  Do not install the product in narrow places where heat tends to build up.
-  Do not use the product in an environment with low heat dissipation. Otherwise, it may cause a malfunction.
-  The RJ-45 port of the product is for use with the product only. Do not connect it to a network. Connecting this port to a network that may receive over-voltage current may cause damage to the product or an electrical shock.
-  Do not use the product in a vehicle or another means of transportation.
-  Do not place the product under direct sunlight or near heaters.
-  This product is designed to be used indoors. Do not use it outdoors. Otherwise, it may cause a malfunction.

Do not use or store the product in the following places.

- 
 - Near heaters
 - Places with lots of humidity or dust, or places subject to oily smoke
 - Places where water or oil may splash
 - Places with lots of corrosive gases, such as near hot springs
 - Places where the product may freeze
 - Do not place the product on its side, face down, or upside down.
 - Places with lots of vibrations

 If you will not be using the product for a long time, disconnect it from the power distributor for safety purposes.

 Disconnect the power supply when performing the maintenance.

 Install the product in accordance with the local laws and regulations.

 Use ESD gloves when handling Pixel cards to prevent static electricity from the human body and contamination due to finger oils, perspiration salts, flaking skin, and/or other forms of human excretory secretions. The LED modules and their electrical components are sensitive to biological agents and exposure to such risks degradation of materials and performance. Eliminate any static electricity from your body before touching the Pixel cards by touching an aluminum sash, a door knob, or some other metal object.

This product can only be serviced in the country where it was purchased.

Recommended Use & Maintenance

About the LED lamps



The surface of the pixel card is vulnerable to shocks, so do not press or hit the surface.



LED lamps are sensitive to static electricity and surge voltage, which may damage their components and decrease their reliability.

Take measures against static electricity during the installation. Do not touch the LED display areas.



When you install the product or when you use it for the first time after leaving it unused for a long time, follow the instructions below.

The LED lamps may absorb and hold moisture during the LED module installation or if not used for a long time. Therefore, in such cases, the brightness must be increased gradually during a break-in period before setting the normal brightness.

If the LED lamps are lit with 100% brightness while moisture is retained, the temperature will rise very quickly and the water inside the lamps will evaporate and expand. This will cause the encapsulating resin to expand, which may lead to separation of the boundary surface inside the LED lamps. This separation can cause the LED lamps not to light up properly.

Lamp break-in

Configure the brightness settings as shown below with a video displayed on the LED module.

After a break-in period of approximately 3 hours, the LED module can be used under normal conditions.

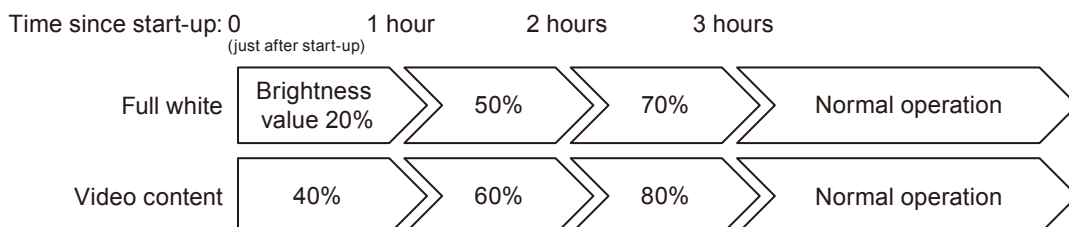

About the Pixel card



The surface of the pixel card is easily scratched, so handle it with care so as not to push or rub it with a hard object. Be careful not to stain the surface of the pixel card with your fingers. If the surface of the pixel card becomes dirty, wipe it gently with a dry cloth. Also, use a clean cloth and avoid using the same cloth repeatedly.

Parts Name

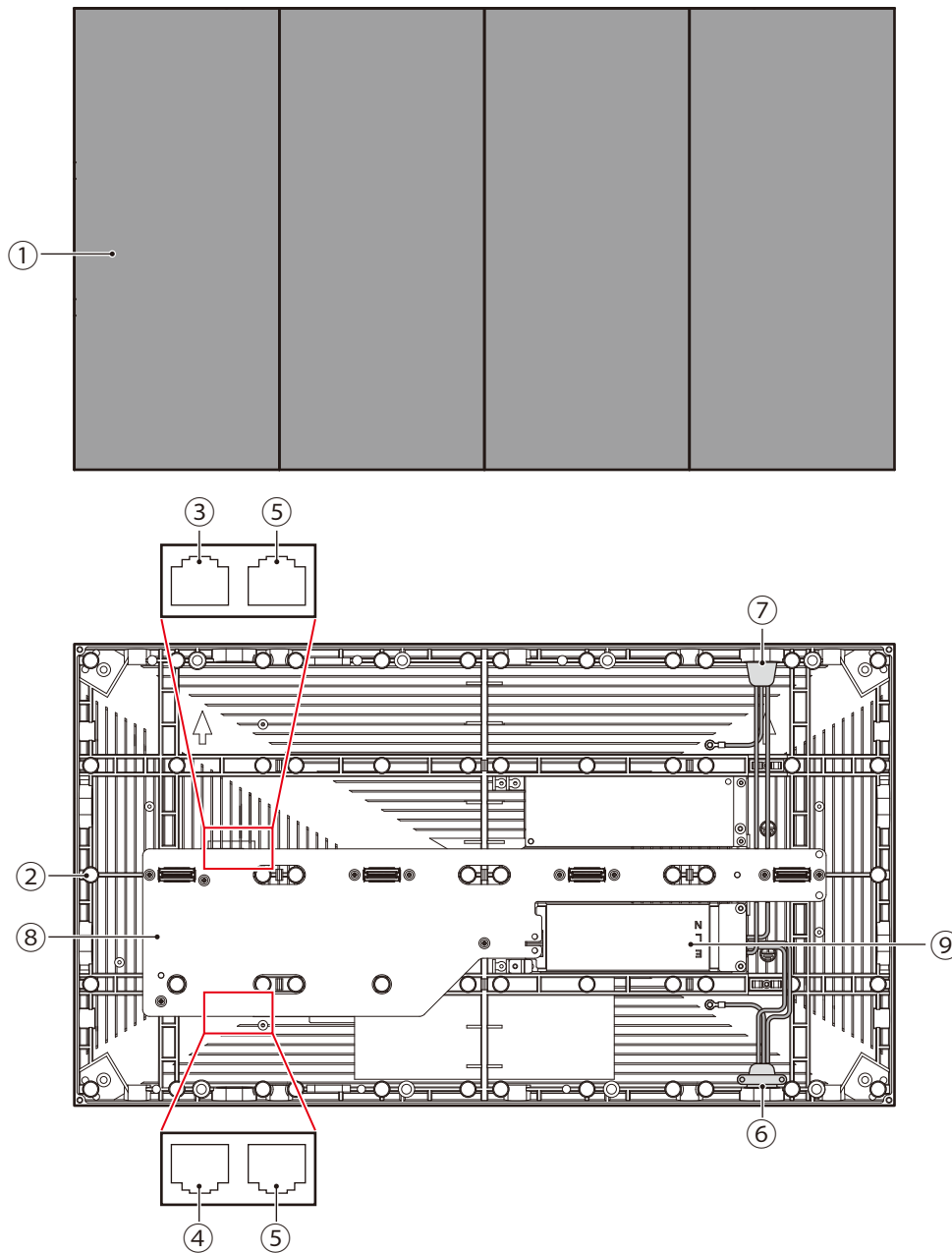



	Name	Description
①	Pixel card	Display section.
②	Cabinet	The chassis to which to install pixel cards.
③ ④	Signal input/output	To input the signal from the LED controller or the previous LED module. When a signal is input into ③, the signal is output from ④. When a signal is input into ④, the signal is output from ③.
⑤	Signal input/output	Not functioning with this device.
⑥ ⑦	Power input (output)	When AC power is input into ⑥, AC power is output from ⑦. When AC power is input into ⑦, AC power is output from ⑥. Do not input AC power into both ⑥ and ⑦.
⑧	Hub board	Pixel card connectors and a receiving card are installed on this board.
⑨	Power unit	Supplies electric power to the pixel cards and receiving card.

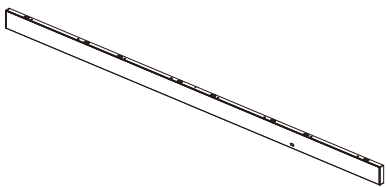
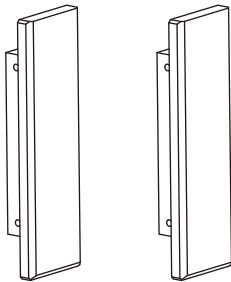
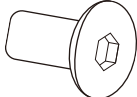
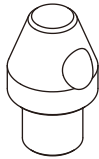
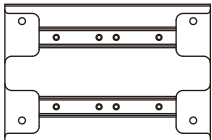
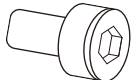
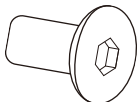
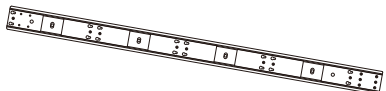
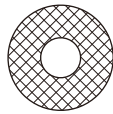

Model name list

4 x 4 frame set	LED-E012i-108/LED-E012i-10N
5 x 5 frame set	LED-E015i-135/LED-E015i-13N
6 x 6 frame set	LED-E018i-162/LED-E018i-16N
8 x 8 frame set (1.2 mm pitch)	LED-E012i-217/LED-E012i-21N
8 x 8 frame set (2.5 mm pitch)	LED-E025i-217/LED-E025i-21N

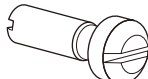
Contents

No.	Parts	Specifications	Quantity					
			4 x 4 frame set	5 x 5 frame set	6 x 6 frame set	8 x 8 frame set (1.2 mm pitch)	8 x 8 frame set (2.5 mm pitch)	
1	Power bar		1	1	1	2		
2	Power bar side cover (left/right)		2	2	2	2		
3	Screw for power bar side cover	M3 (Type B)	9 (4+5*1)	9 (4+5*1)	9 (4+5*1)	9 (4+5*1)		
	Power bar position pin		9 (4+5*1)	9 (4+5*1)	11 (6+5*1)	13 (8+5*1)		
	Screw for power bar front cover	M6	5*1	5*1	5*1	5*1		
4	Power bar connecting part		-	-	-	1		
5	Power bar connecting screw	M3 (Type A)	-	-	-	9 (4+5*1)		
		M3 (Type B)	-	-	-	13 (8+5*1)		
6	Mounting bar		2	2	3	4		
	Bolt washer	20 mm	13 (8+5*1)	15 (10+5*1)	23 (18+5*1)	37 (32+5*1)		
	Alignment bar		2	2	2	2		
	Cabinet hanger pin	Head diameter 10 mm x 25 mm	21 (16+5*1)	25 (20+5*1)	41 (36+5*1)	69 (64+5*1)		

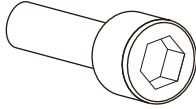
*1: Spare parts

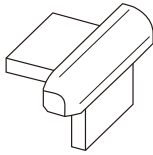
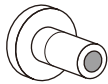
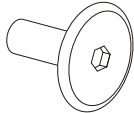
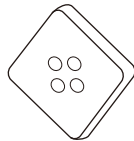
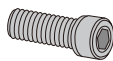
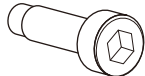
No.	Parts	Specifications	Quantity					
			4 x 4 frame set	5 x 5 frame set	6 x 6 frame set	8 x 8 frame set (1.2 mm pitch)	8 x 8 frame set (2.5 mm pitch)	
7	Power bar screw	M6 x 16	11 (6+5*1)	11 (6+5*1)	14 (9+5*1)	17 (12+5*1)		
8	Over frame (top)		1	1	1	2		
9	Over frame (left, right)		2	2	2	2		
10	Corner frame		2	2	2	2		
	Slot nut		17 (12+5*1)	17 (12+5*1)	17 (12+5*1)	29 (24+5*1)		
	Screw for overframe	M3 x 10 mm	17 (12+5*1)	17 (12+5*1)	17 (12+5*1)	29 (24+5*1)		
	Adjustment plate	35 x 35 x 6 mm	10	12	14	18		
	Screw for Adjustment plates	Hexagonal socket head screw (M4 x 12)	45 (40+5*1)	53 (48+5*1)	61 (56+5*1)	77 (72+5*1)		
	Pixel card		64	100	144	256		
	Cabinet	600 mm x 337.5 mm	16	25	36	64		
	Screw for connecting cabinets	M6 x 26 mm	65 (60+5*1)	105 (100+5*1)	155 (150+5*1)	285 (280+5*1)		
	Screw for cabinet (to Power bar)	M6 x 25 mm	17 (12+5*1)	20 (15+5*1)	23 (18+5*1)	29 (24+5*1)		
	LED controller*2	Novastar MCTRL 660Pro	1	1	1	-	1	
		Novastar MCTRL 4K	-	-	-	1	-	
	LAN cable for the LED modules	750 mm	-	-	-	-	4	
		170 mm	12	20	30	48	56	
	LAN cable for the LED controller*2	20000 mm	4	5	6	16	8	
	Power cord for the LED controller*2		1	1	1	1		
	USB flash memory		1	1	1	1		
	Safety Manual		1	1	1	1		
	Power cord*3		*3	*3	*3	*3		

*1: Spare parts

*2: Kit model only (except LED-E012i-10N, LED-E015i-13N, LED-E018i-16N, LED-E012i-21N and LED-E025i-21N)

*3: Can be ordered by optional

Four different wall-mount frames can be used depending on the system size. Ask your retailer for more details. For other configurations, the number of contents will vary. Please contact your retailer for more information.

8 x 8 frame set

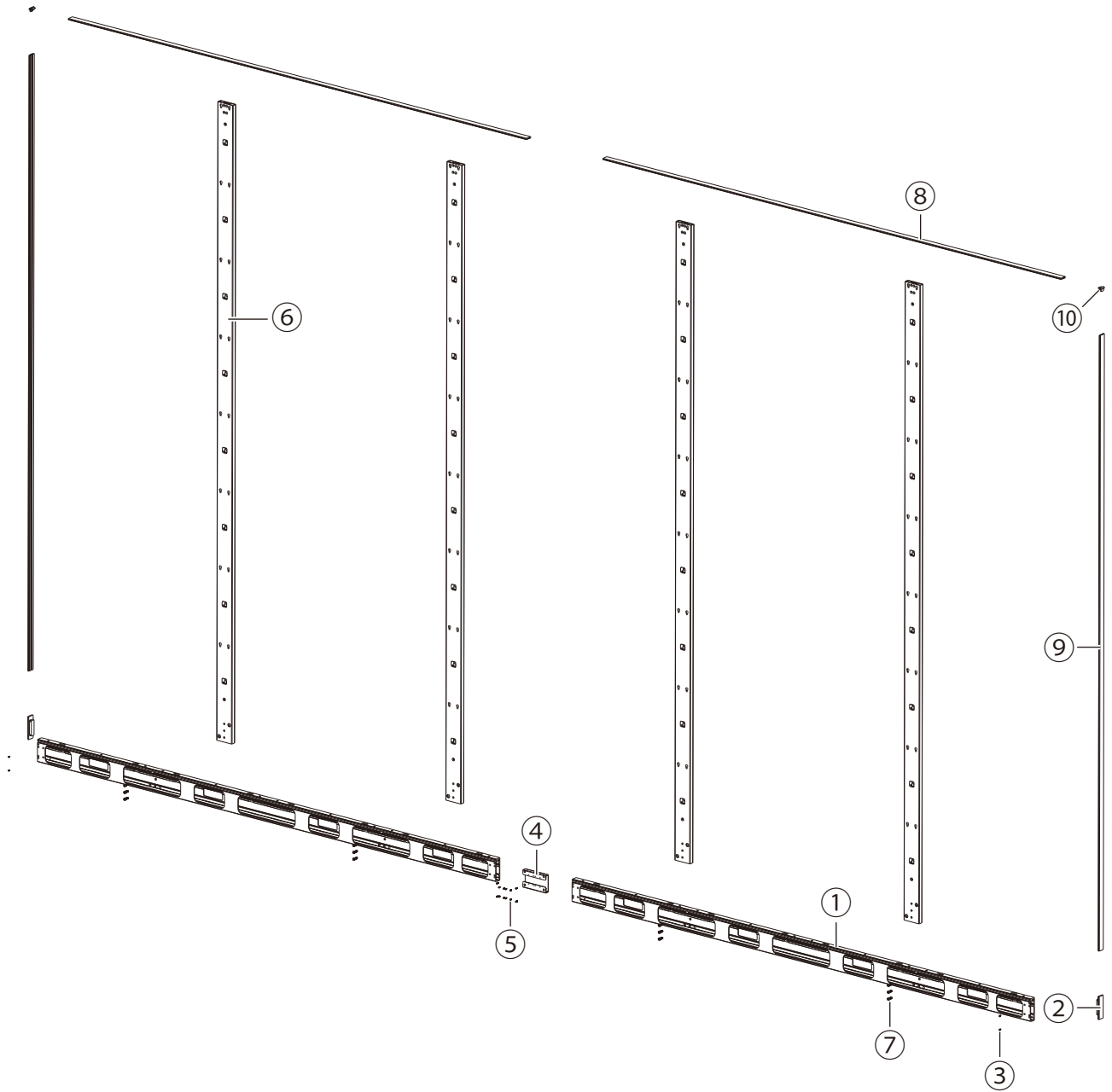

Installation Example

1. Installation location

Before the installation, be sure to review the following safety precautions to ensure proper and safe installation.

⚠ CAUTION

- Ask a technician to perform the installation.
- Make sure the product is moved and installed by enough people to ensure safety.
- Make sure that the beams or the other structures to which the product is installed have enough strength to support the weight of the product, and make sure that the product is securely fixed.
- Do not install directly the product to a surface that has not enough strength.
- When installing the product in an environment with much dust or dirt, be careful to prevent such material from adhering to the connectors on the hub board and pixel card.
Adhesion of dust or dirt to the connectors may cause poor contact, leading to abnormalities of video display.
- When installing the product in a narrow place (in a wall, etc.), leave enough gaps around the LED screens to prevent an increase in the temperature.
Make sure to use the product lower than the normal operating temperature.
The top of the LED module should always be installed so that the temperature is below 40°C.
Pay particular attention to the installation environment (heat from the external environment, direct sunlight, heat generated by the number of displays) in order to facilitate cooling of the LED modules.
If cooling is not sufficient, take measures, such as increasing the distance from the walls or installing a forced-air cooling system.
Ask a technician or your retailer for more details.

There is an example for setting.

In wall setting

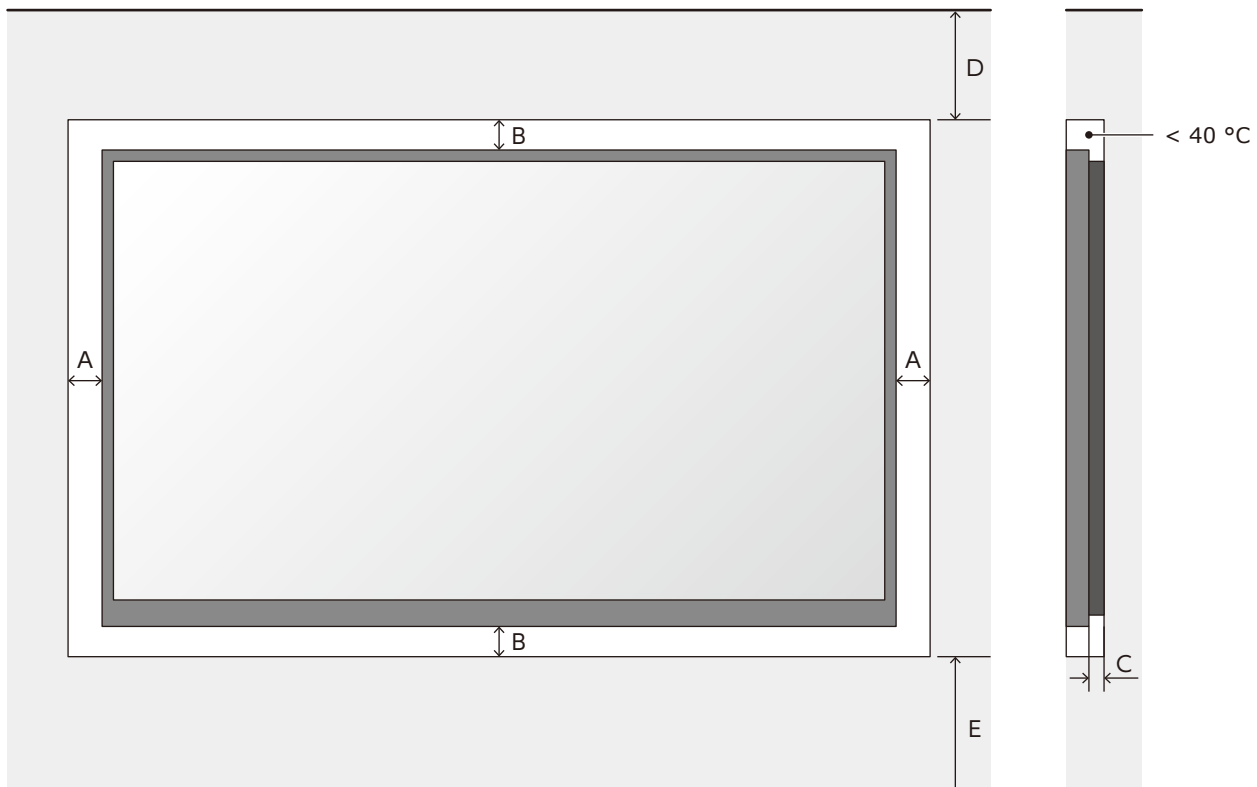

A	B	C
min. distance to sides	min. distance to top and bottom	min. distance between wall and system
60 mm	60 mm	20 mm

D	E
Recommended distance to ceiling	Recommended distance to floor
500 mm*	500 mm*

*: Depending on the temperature condition.

Wall mounting setting

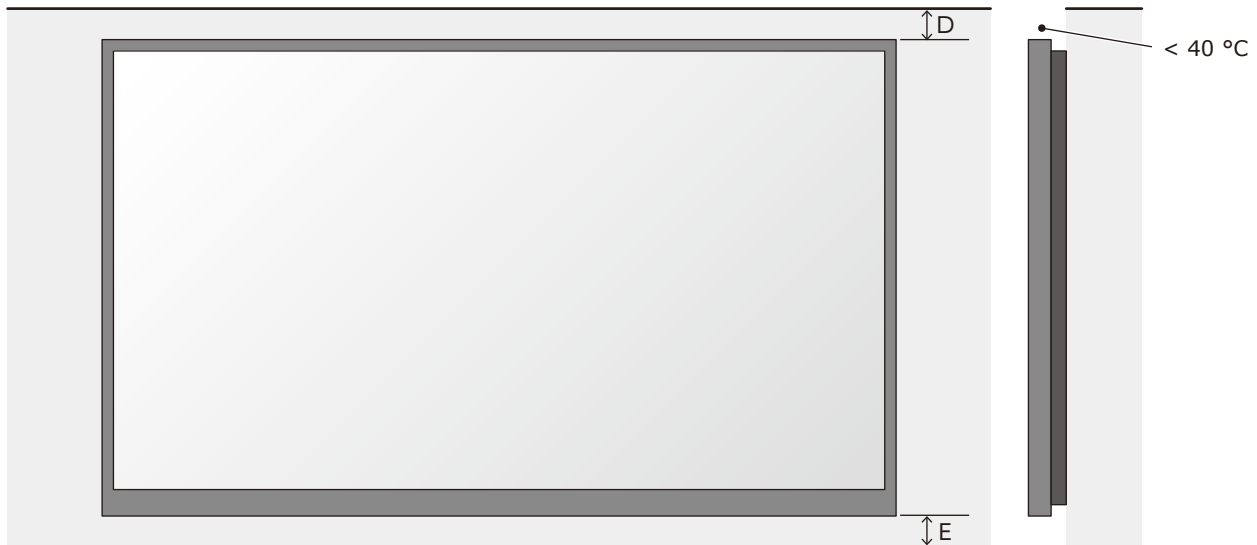

D	E
Recommended distance to ceiling	Recommended distance to floor
500 mm*	500 mm*

*: Depending on the temperature condition.

If the distances are lower than these value, the cooling might not sufficient. Take measures, such as increasing the distance from the walls or installing a forced-air cooling system.

2. Mark the positions of the anchor points on the wall

- Mark the positions of the holes you will make for the anchor points (refer to the figures below and the "Anchor points number and positions" table on the next page).
- Before making the holes, check the verticality of the marks using a spirit level or a laser line level. (We recommend using a laser line level is recommended for accuracy.)

Anchor points positions: 4 x 4 frame set

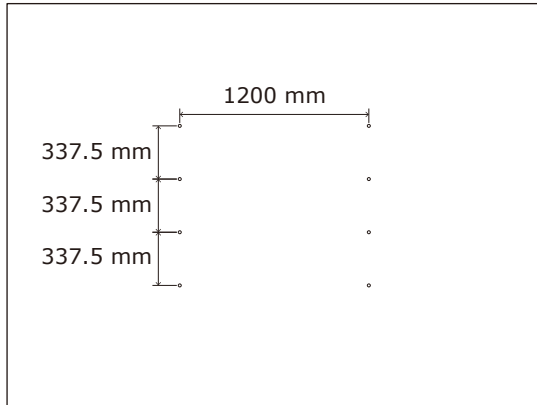

Anchor points positions: 5 x 5 frame set

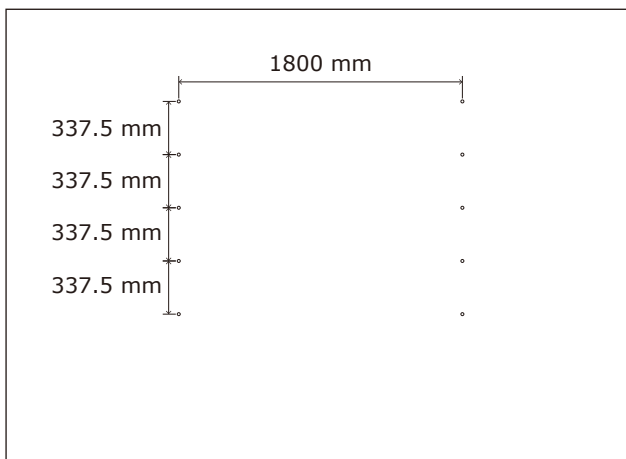

Anchor points positions: 6 x 6 frame set

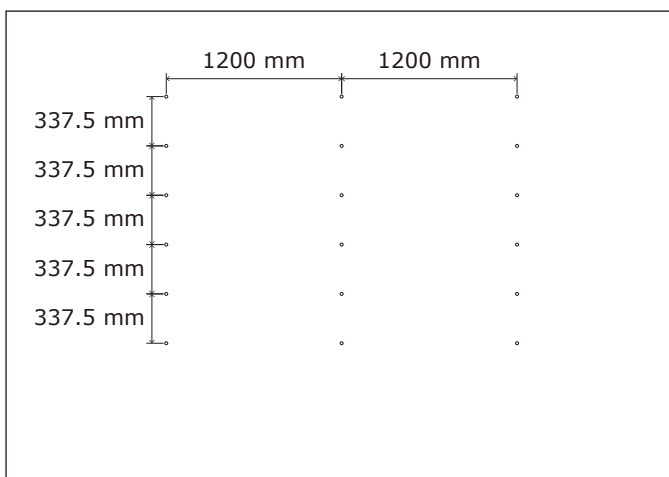

Anchor points positions: 8 x 8 frame set

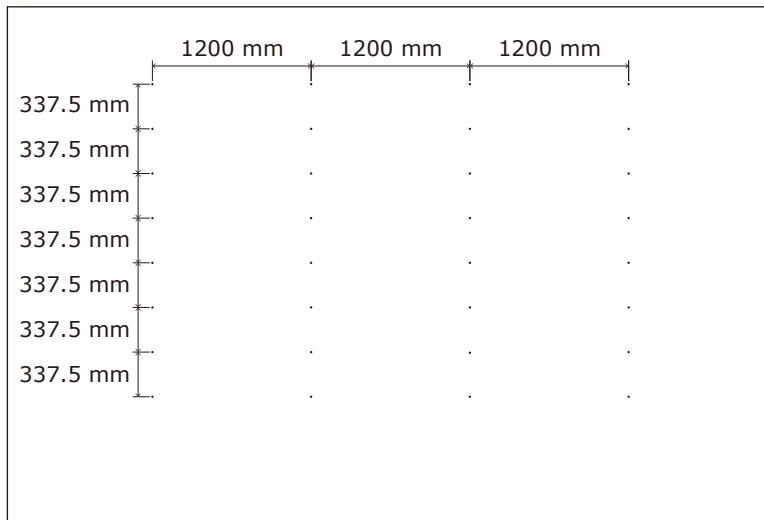

Anchor points number and positions

Frame set	4x4	5x5	6x6	8x8
Anchor points (horizontal x vertical)	2x4	2x5	3x5	4x8
Horizontal distance	1200 mm	1800 mm	1200 mm	1200 mm
Vertical distance	337.5 mm	337.5 mm	337.5 mm	337.5 mm
Anchor size	Ø10 mm	Ø10 mm	Ø10 mm	Ø10 mm

3. Make the holes at the anchor positions

- Make holes at the anchor positions using a suitable tool.
- Use screw anchors/anchor plugs as required.
- Remove the dust or dirt, and wipe off any drilling chips and dust.

4. Install the mounting bars

- (1) Install the mounting bars on the anchor points on the wall.
- (2) Check the distance between the mounting bars using the alignment bars.

4 x 4 frame set

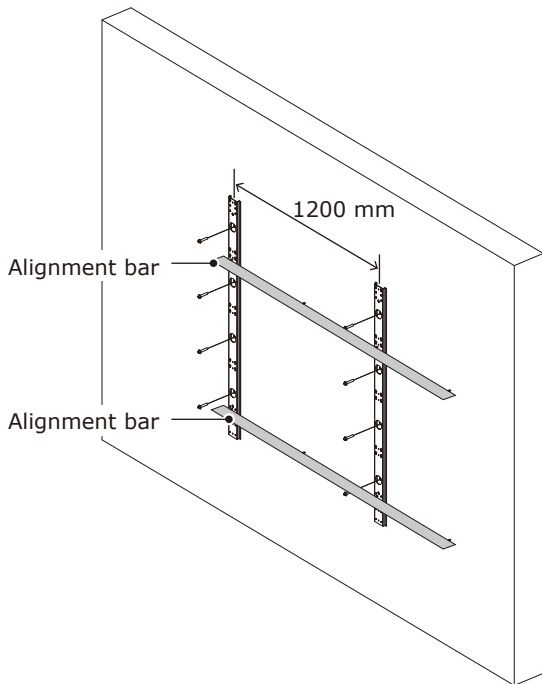

5 x 5 frame set

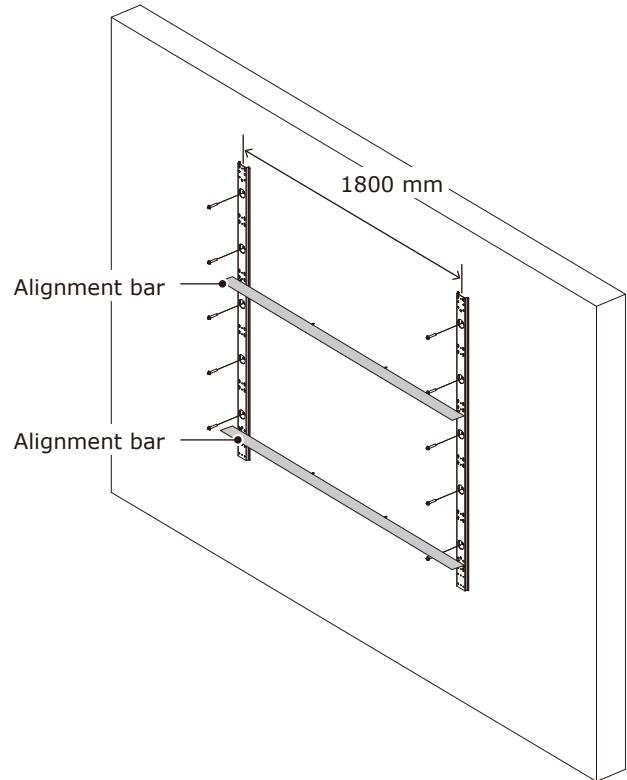

6 x 6 frame set

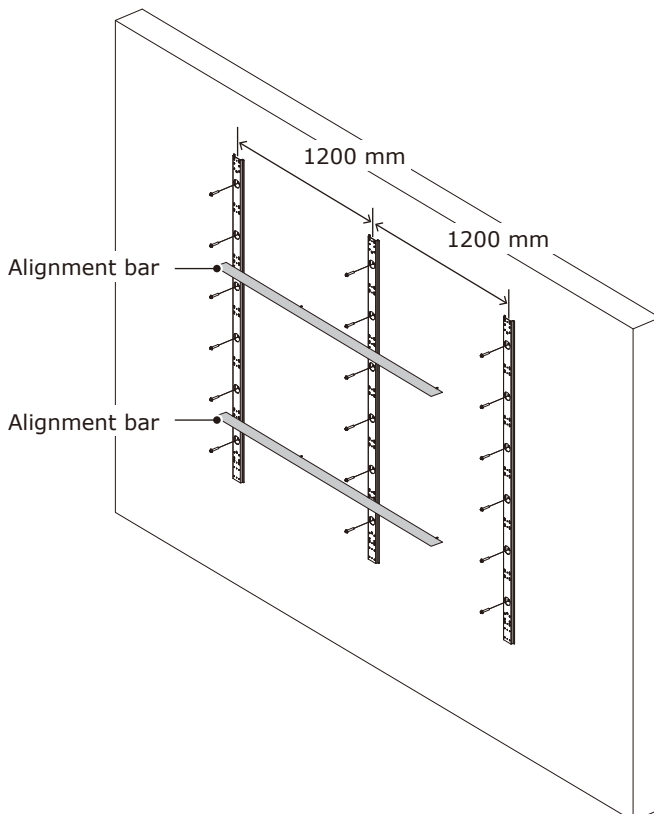

8 x 8 frame set

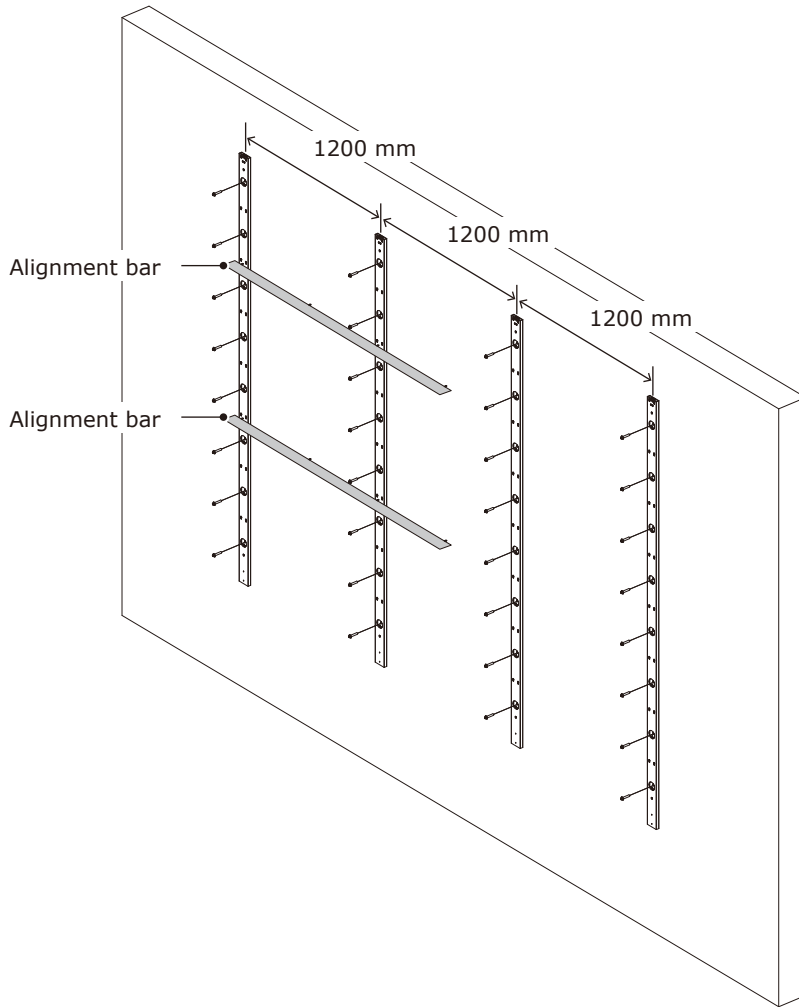

- (3) Check the evenness using a spirit level or a laser line level and the alignment bars together. Adjust the positions if required.

Wall mounted: Mounting bar installation (5 x 5 frame set)

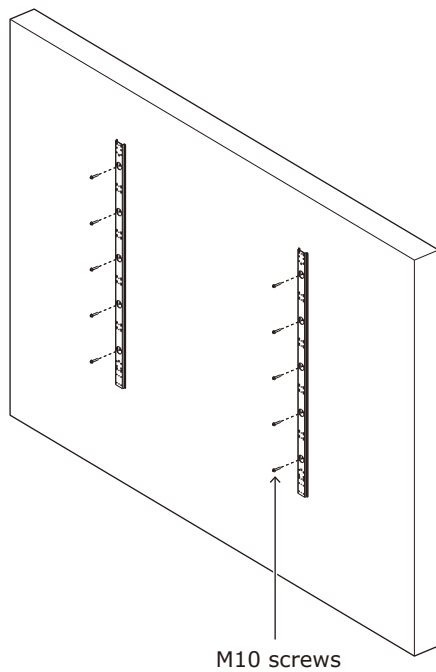

5. Install the power bar

Remove the power bar cover and install the power bar using M6 screws.

How to remove the bottom cover

(1) Remove the screws securing the power bar cover.

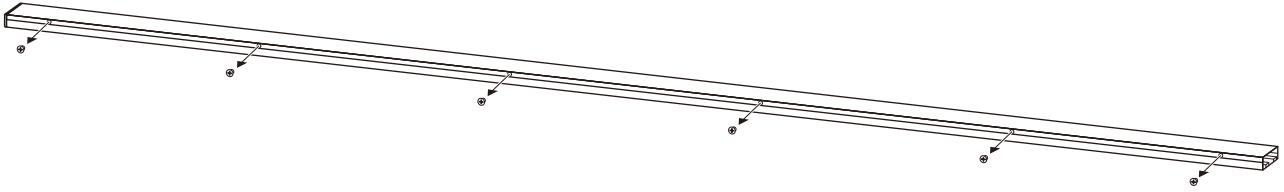

(2) Raise the front of the power bar cover.

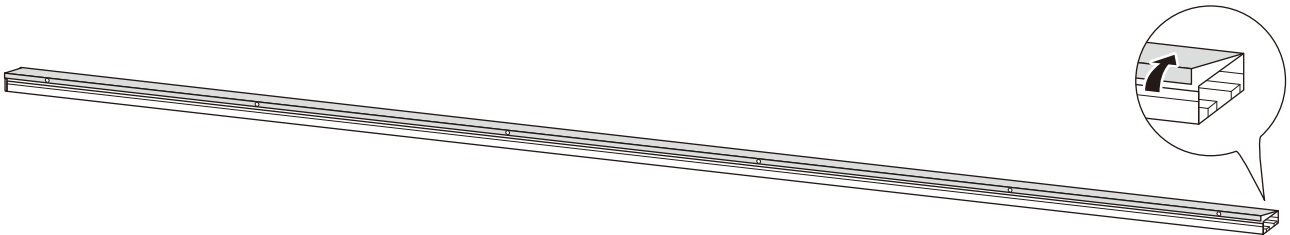

(3) Pull the power bar cover toward you to remove it.

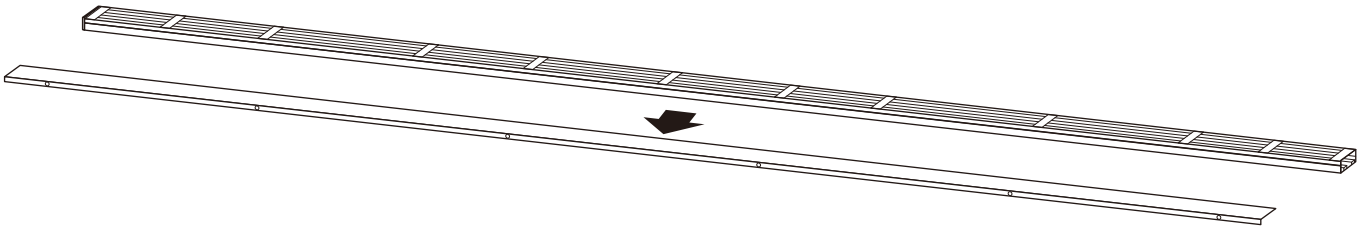

How to attach the power bar position pin

Attach the power bar position pin to the power bar.

- 4 x 4 frame set: 2 pieces x 2 places
- 5 x 5 frame set: 2 pieces x 2 places
- 6 x 6 frame set: 2 pieces x 3 places
- 8 x 8 frame set: 2 pieces x 2 places x 2 power bar

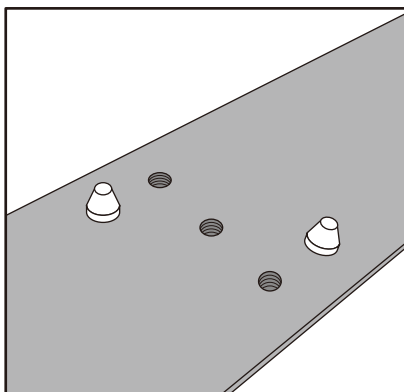

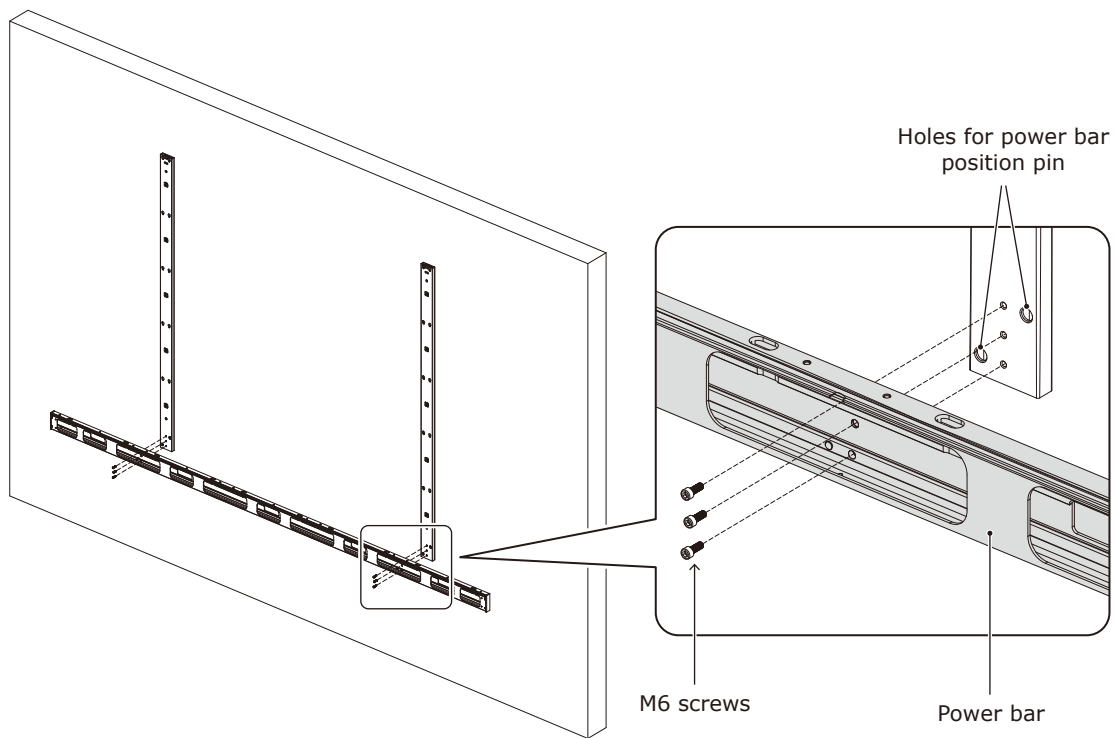

When using the 8 x 8 frame set, use the power bar connecting part to install the power bar.

Power bar connecting screw (M3 (Type A))
(4 red circles)

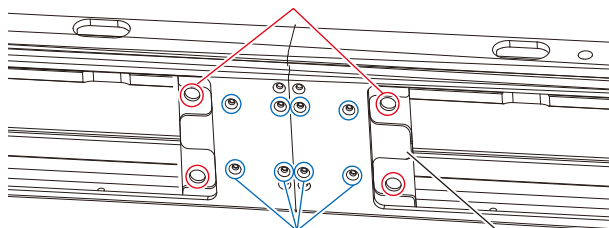

Power bar connecting screw (M3 (Type B)) (8 blue circles) Power bar connecting part

6. Install the cabinet hanger pins to the back of the cabinets

The following drawings indicate where Hanger pins are required. Insert the Hanger pins until the pitch of the screws is no longer visible.

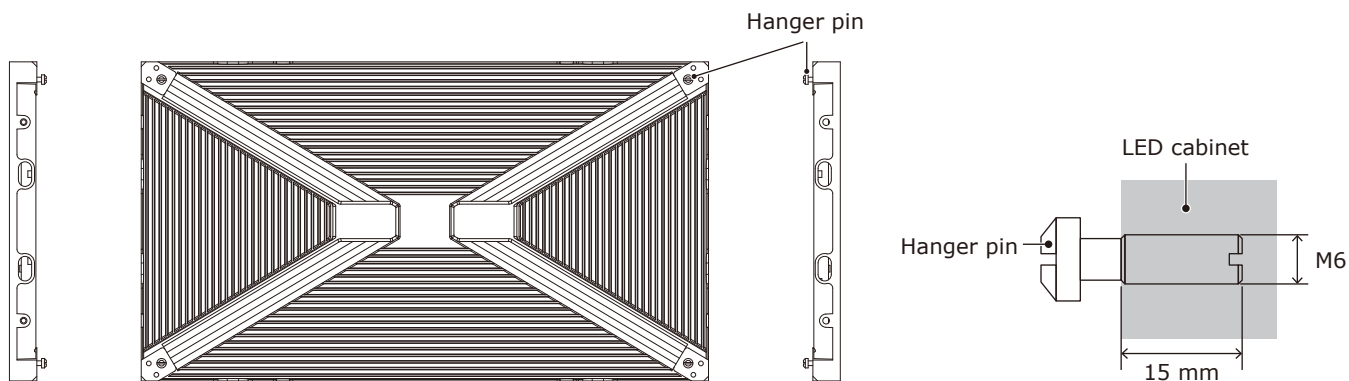

Cabinet hanger pins installation position

4 x 4 frame set

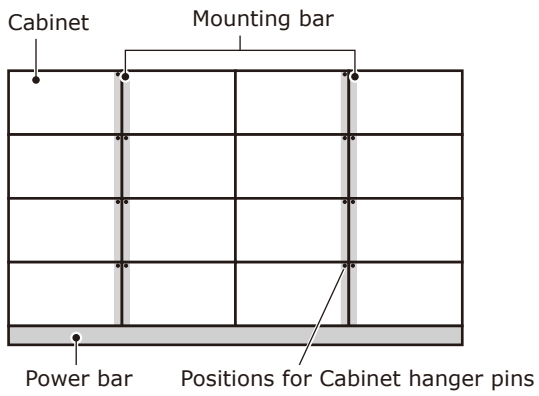

5 x 5 frame set

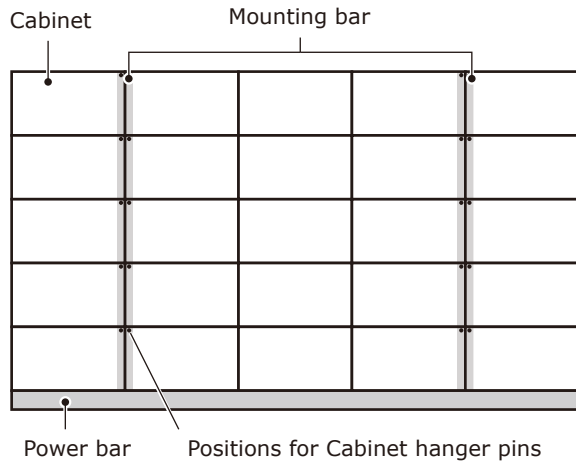

6 x 6 frame set

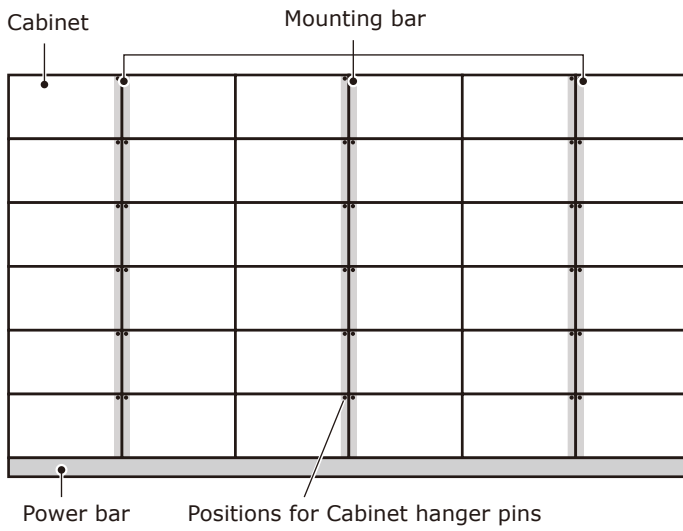

8 x 8 frame set

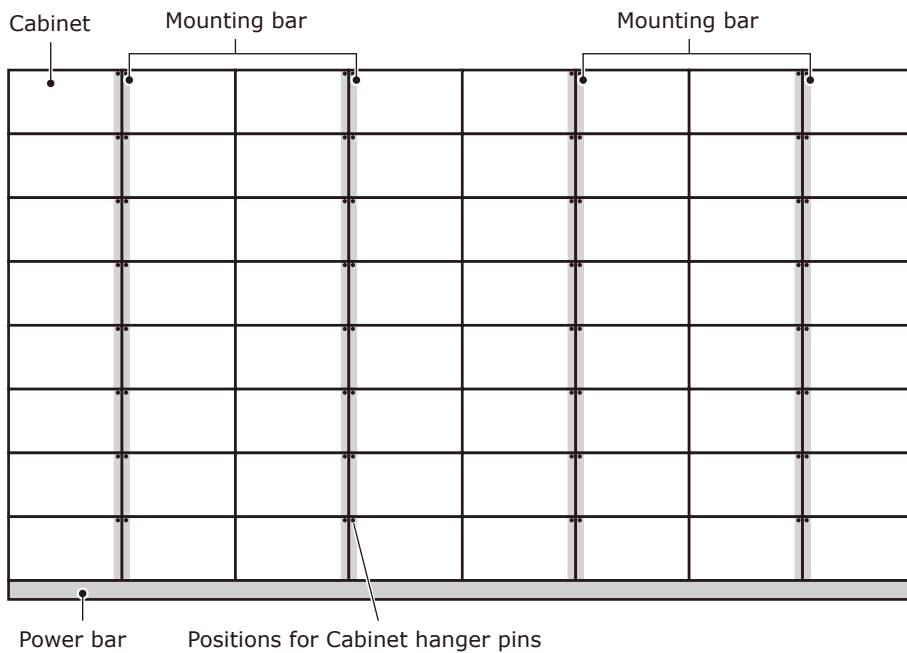

7. Install the cabinets

Hook the hanger pins, which have been inserted into the cabinets, into the holes on the mounting bars starting from the lowest row.

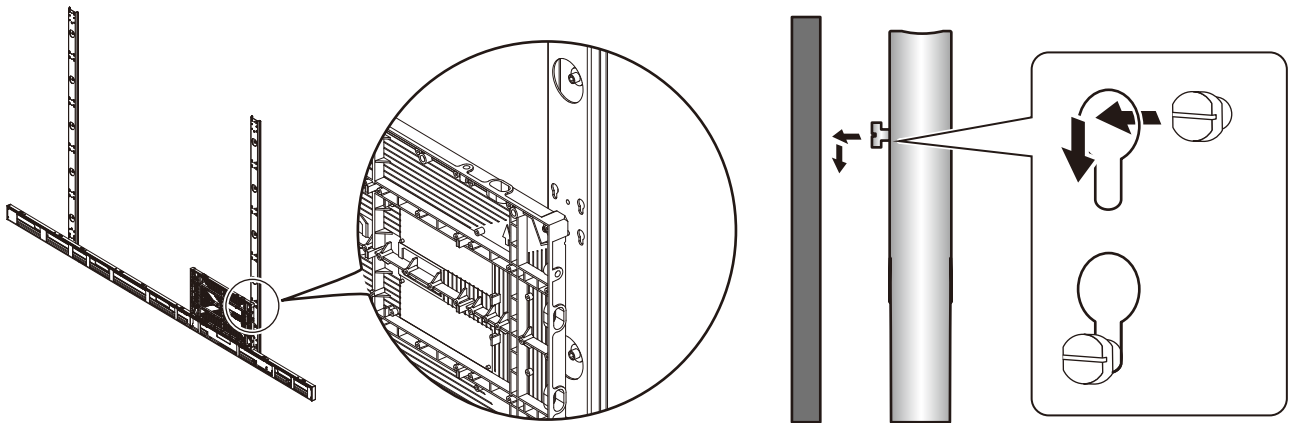

Fix temporarily the cabinets of the first row to the power bar.

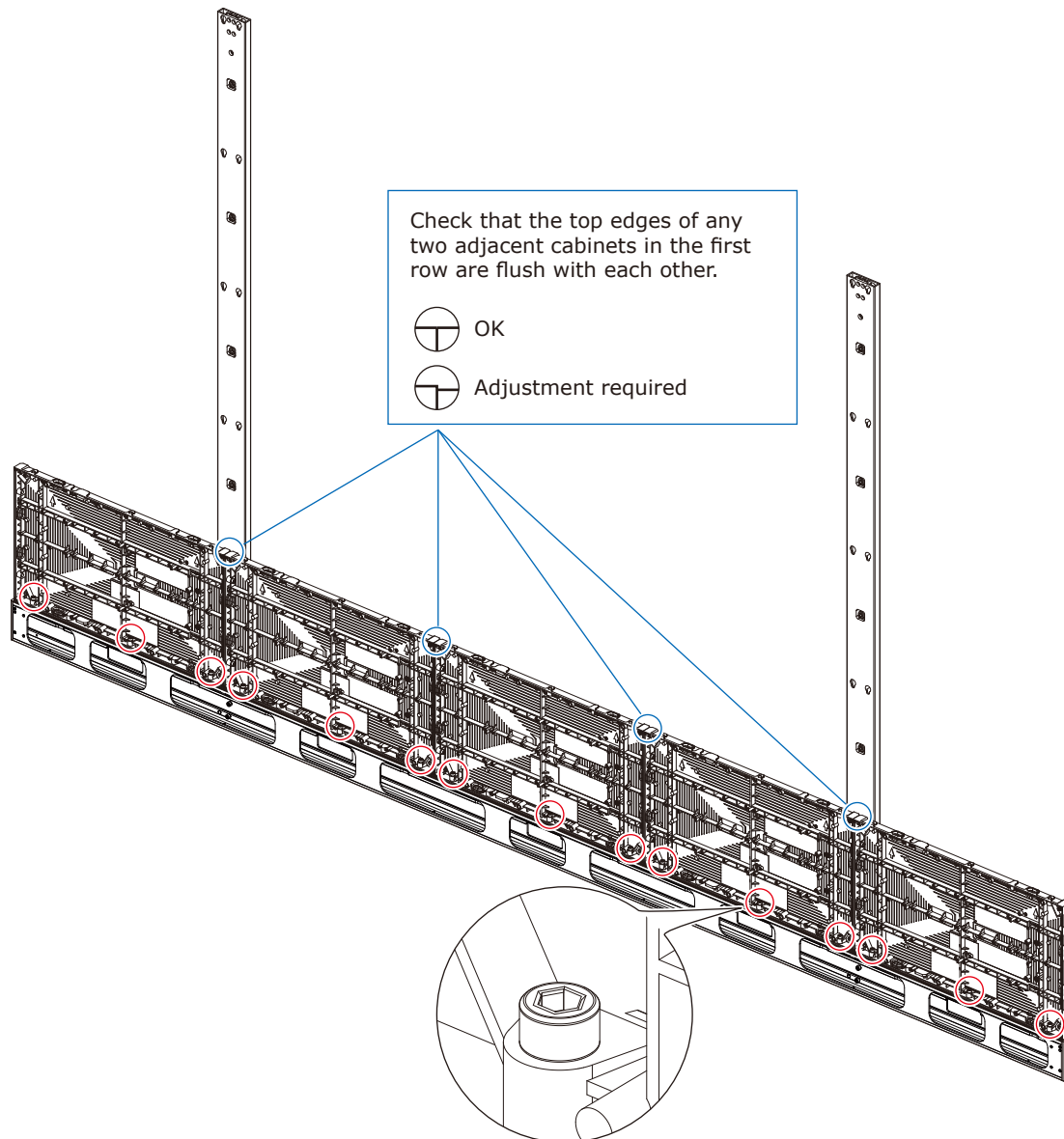

Hook the hanger pins of the cabinets of the second row to the mounting bars.
Secure the LED cabinets together using screws for connecting cabinets. Do not tighten the screws completely.

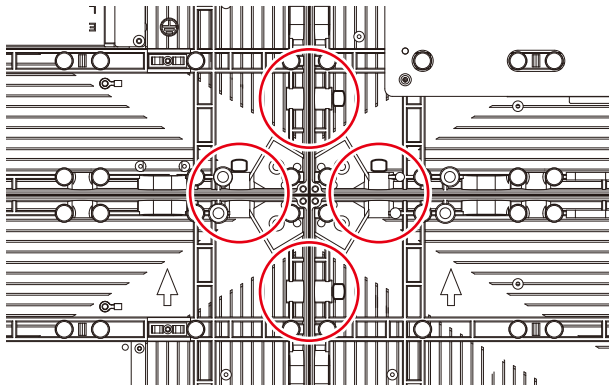

After you have installed two rows of cabinets, align the surfaces of the cabinets using the Adjustment plates.

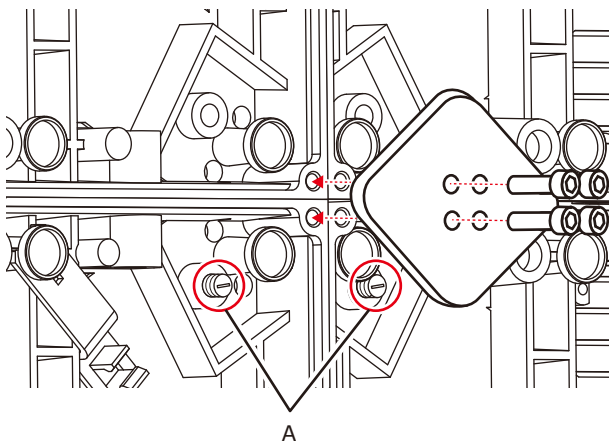

When the cabinets' surfaces are aligned, securely tighten the cabinets of the first row to the power bar, the cabinets of the first row together, as well as the cabinets of the first row with the cabinets of the second row. Remove the Adjustment plates after the screws have been tightened.

Adjust the position of the cabinet and the mounting bar by rotating the screws A on the figure with a flat blade screwdriver. Rotate the screws counterclockwise to bring the cabinet closer to the mounting bar.

Follow the same procedure to install the next row of cabinets and align their surfaces.

Connect the power cord and the LAN cable from the opening at the back of the power bar.

(1) Power cord connection

Connect the power cords to the LED modules on the first row.

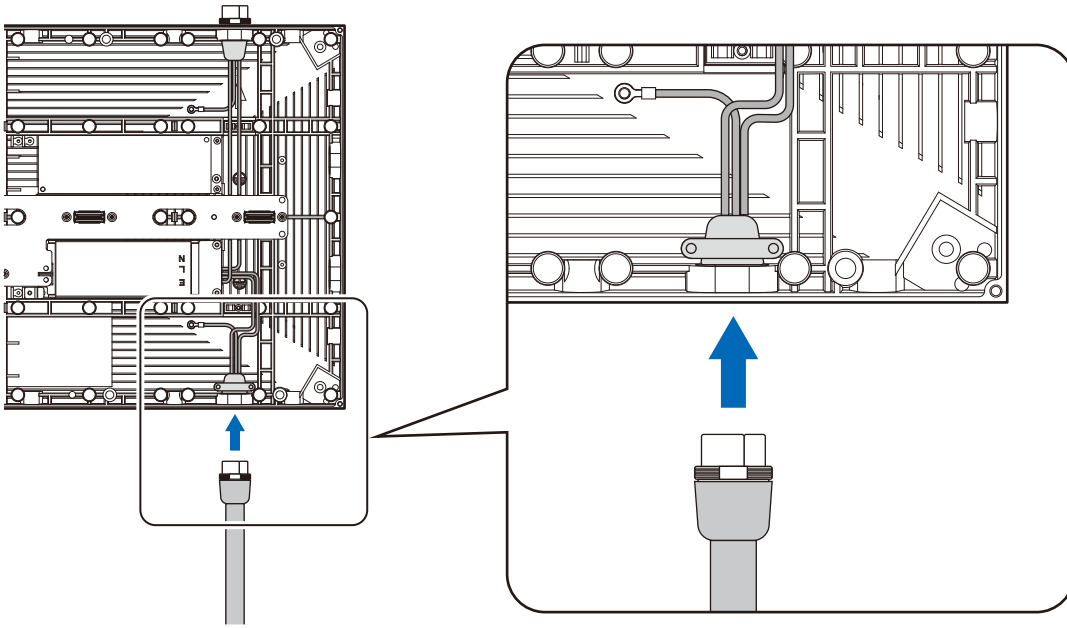

The power cord must be securely plugged.

Connect the power cords between the LED modules.

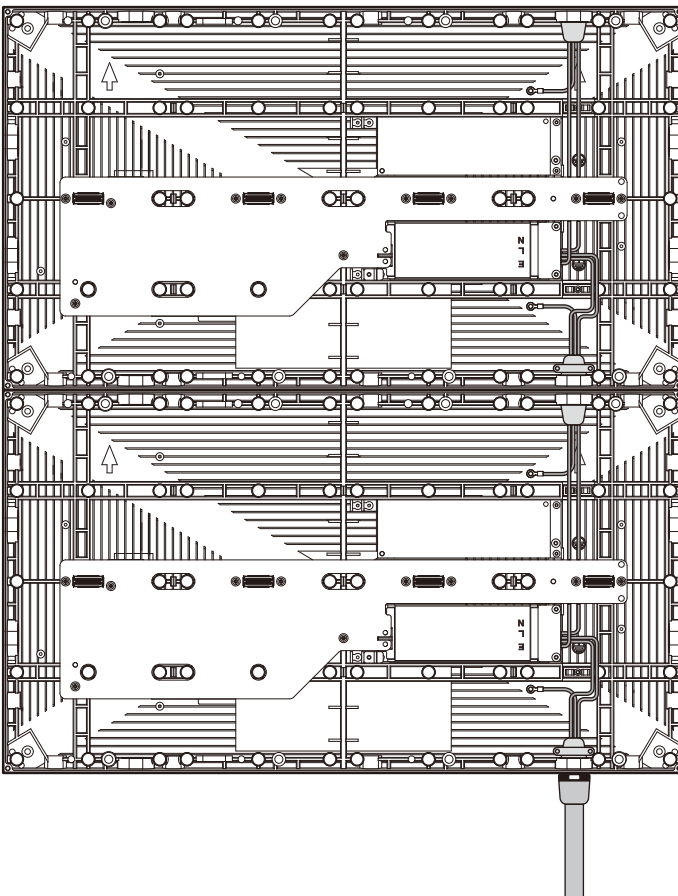

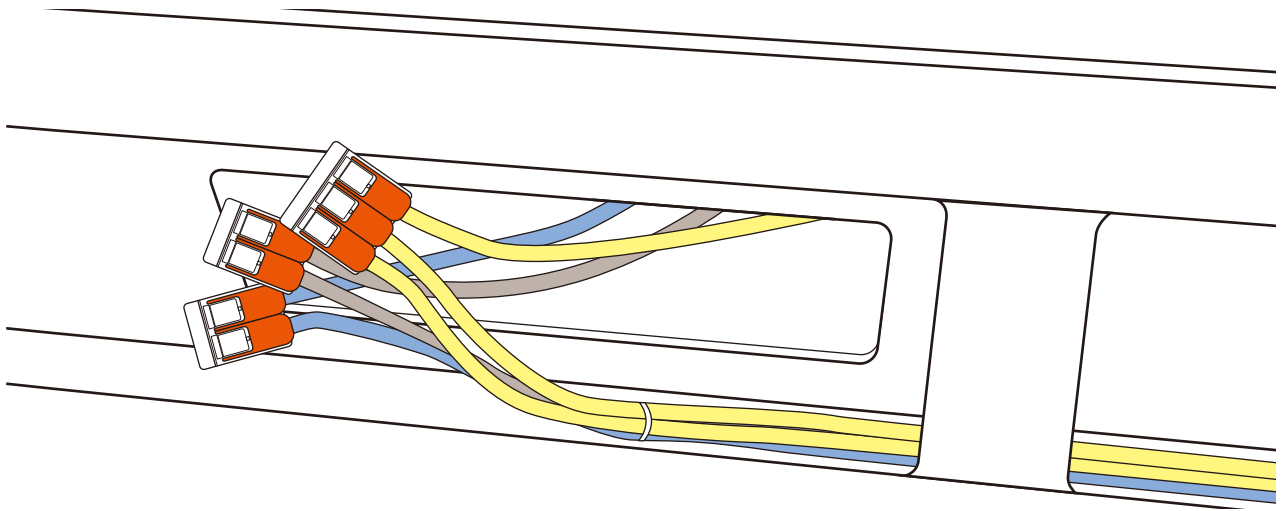

Precautions on use of the power connector (WAGO)

When using the power cord connector (WAGO's product, WFR Series (WAGO 221), Models WFR-2 and WFR-3), respect the following precautions.

WAGO 221



* Visiting WAGO's homepage for more details is recommended.

⚠ WARNING

- Always use the connector indoors (in a location not affected by moisture).
- Use the connector by respecting the installation precautions. If the connector is not used correctly, it may lead to a fire or an electrical shock.

Installation precautions

- Wire sheath peeling

⚠ CAUTION

Be sure to peel off the wire sheath over the specified length.

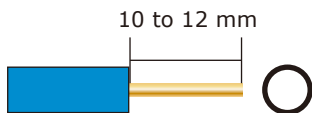

⚠ CAUTION

Do not use the connector with the core wires being sinuous.

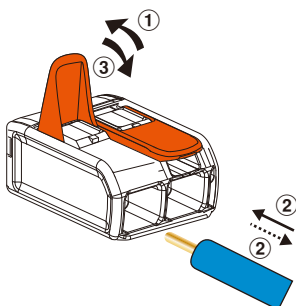

Lever operation is necessary even for connection of a solid core wire.

- Wire sizes

Wire sizes compatible with the power connector (WAGO) are as follows.

- Solid core: $\phi 1.6$ to 2.0 mm
- IV 7-stranded core: 2.0 to 3.5 mm²
- Flexible stranded core: 2.0 to 3.5 mm²

- When reconnecting a wire once disconnected, cut off the wire end and newly peel off the sheath.

⚠ CAUTION

- When reconnecting a wire once disconnected, cut off the wire end and newly peel off the sheath.
- If the disconnected wire is reconnected without this processing, it may heat up and burn out.

Newly peel off the sheath.

End of disconnected wire: More or less damaged.



How to connect the power cord

(1) Raise the lever.

(2) Insert the wire.

(3) Return the lever to its previous position.

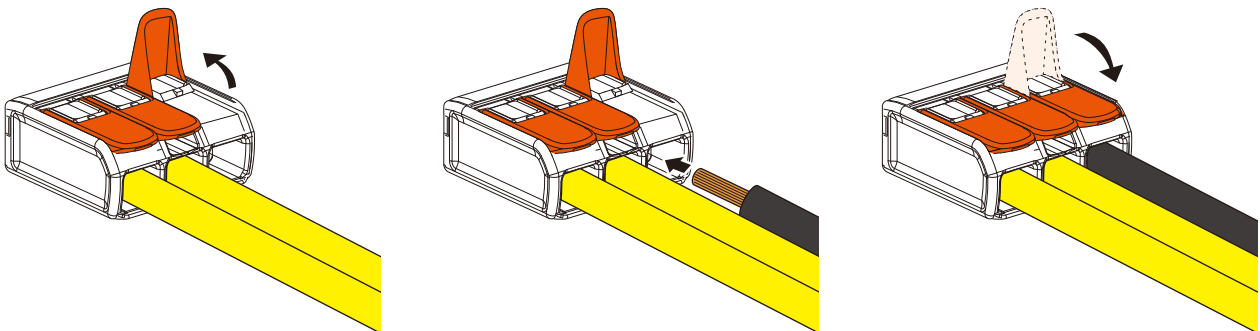

⚠ CAUTION

Insufficient insertion may cause poor electricity conduction and heat generation.

Power code connection checking

- Perform checking for correct and proper connection.

Lightly pull on the wires one by one to check that they will not be pulled out.

Check visually

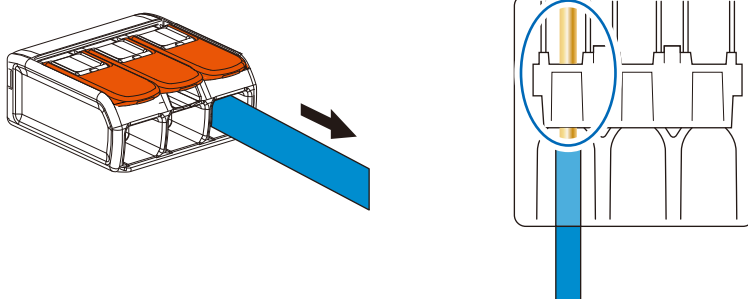

⚠ WARNING

Pay attention to the wire colors of the power cord when connecting the cord. If the cables are not connected correctly, it may lead to a fire or an electrical shock.

- Blue (N)
- Brown (L)
- Yellow green (Ground)

(2) LAN cable connection

Connect the LAN cables for the signal between the LED modules. Use the through holes to pass the cables between the modules.

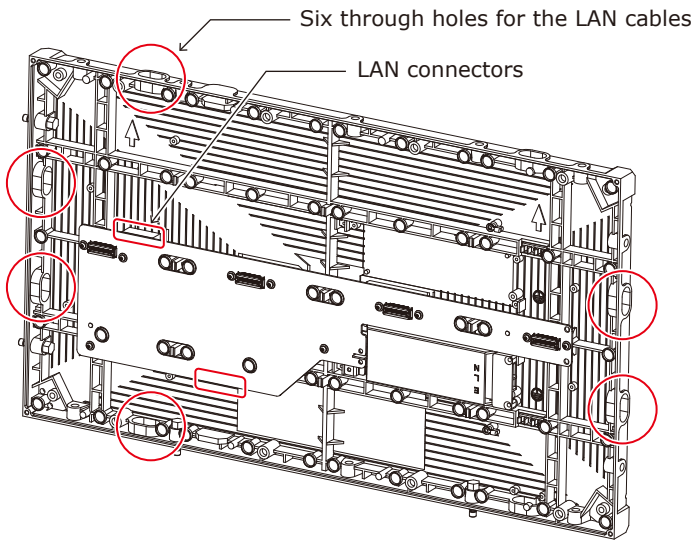

[Connection example] Connecting from bottom to top using multiple ports

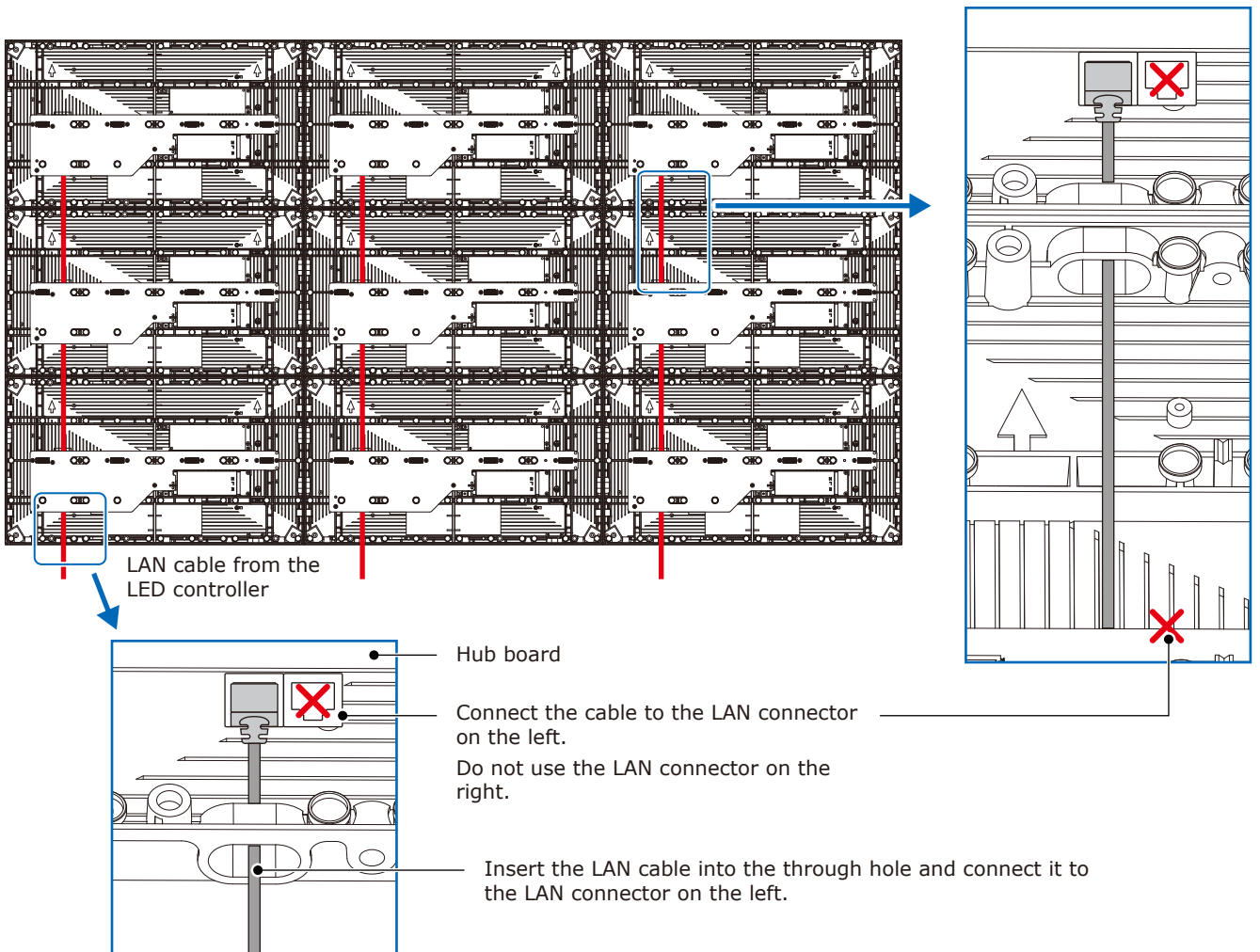

Install the power bar cover and power bar side covers using the screws when it was installed (on the front).

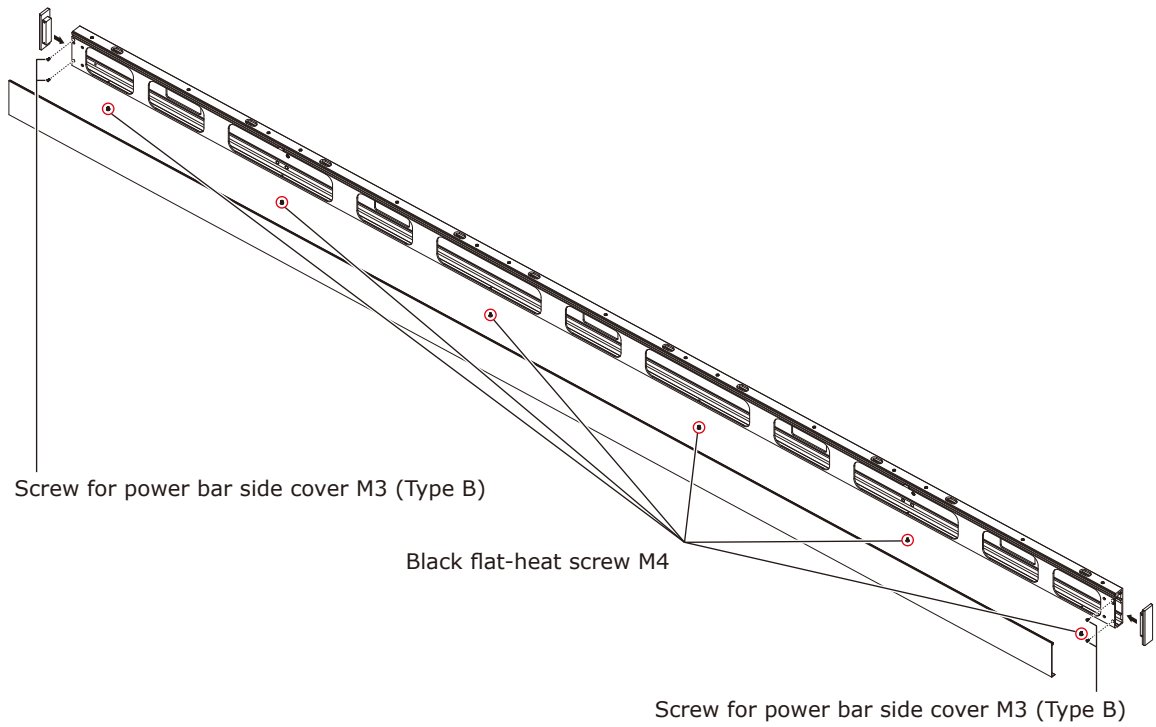

Insert the slot nuts inside the over frame into the holes of the screw for connecting cabinets and fix them with M3 screws.

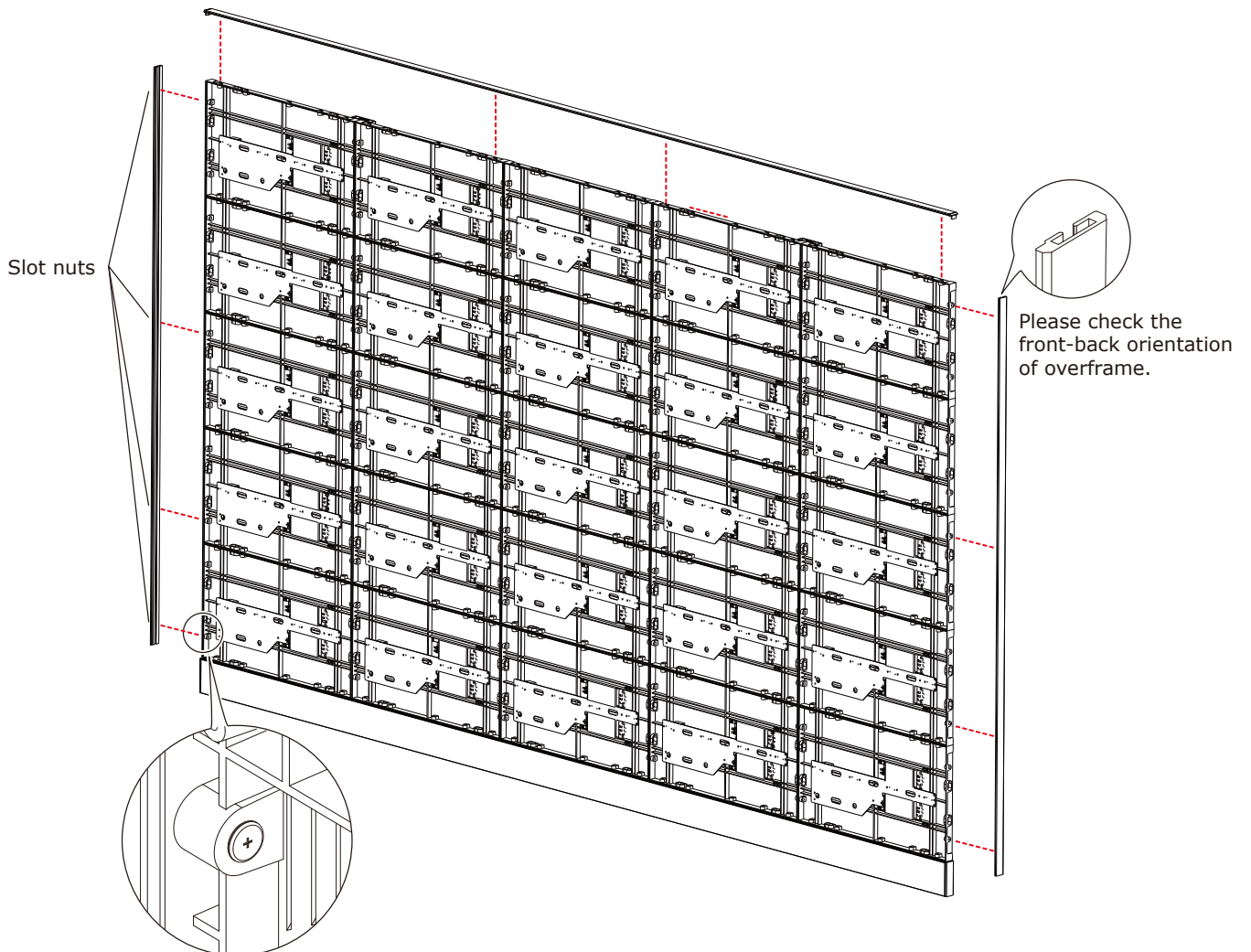

Install the corner parts to the over frame (top) and install it on the top of the cabinets.

Slot nut installation locations

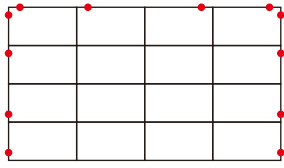

4 x 4 frame set

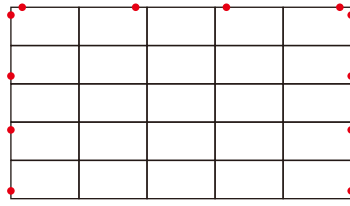

5 x 5 frame set

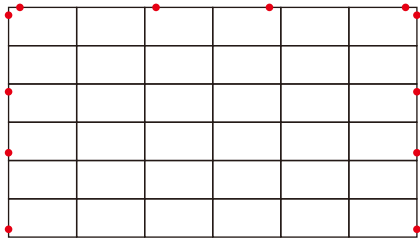

6 x 6 frame set

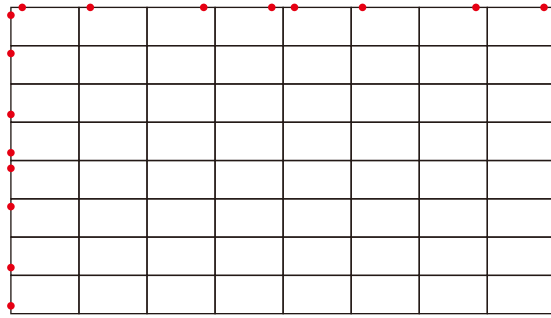

8 x 8 frame set

8. Assembly diagrams

4 x 4 frame set

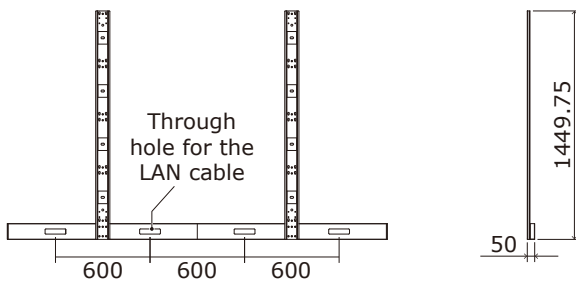
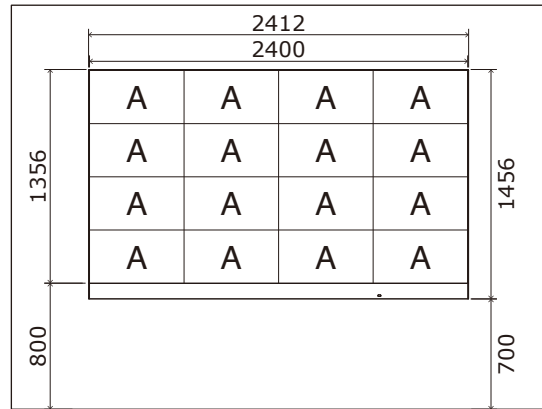
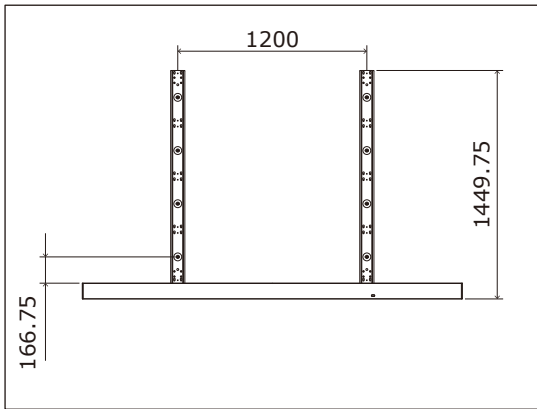

5 x 5 frame set

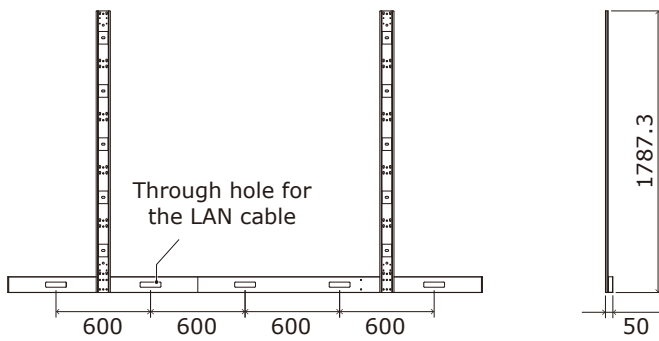
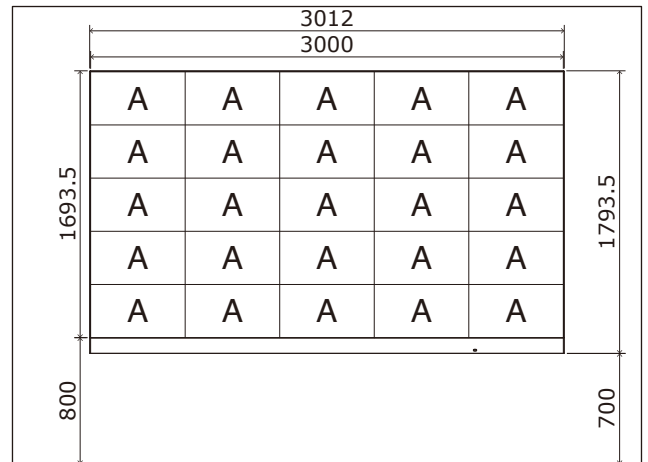
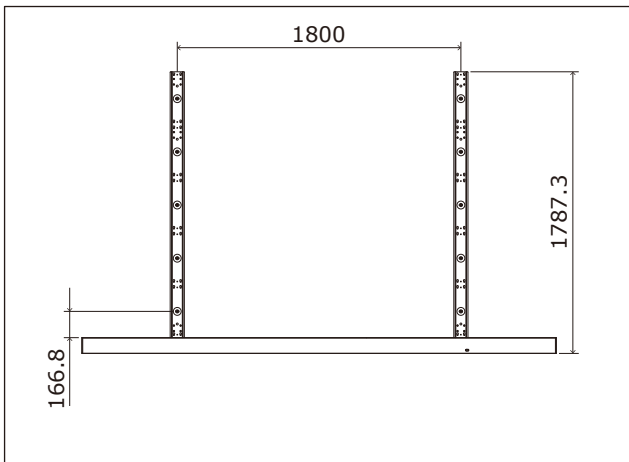

6 x 6 frame set

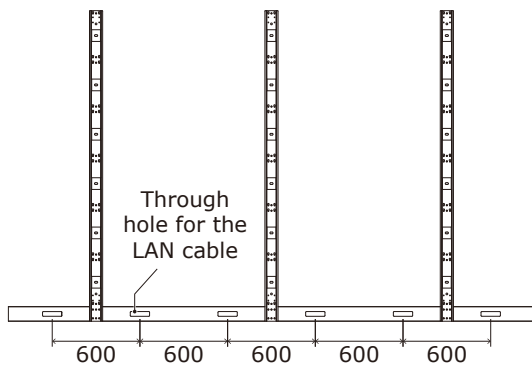
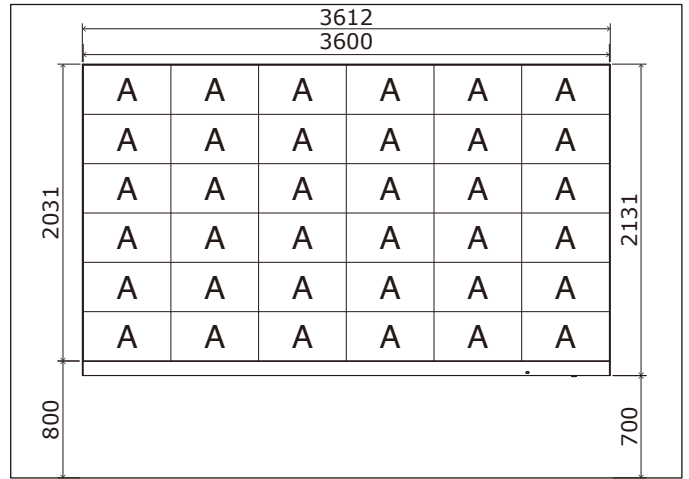
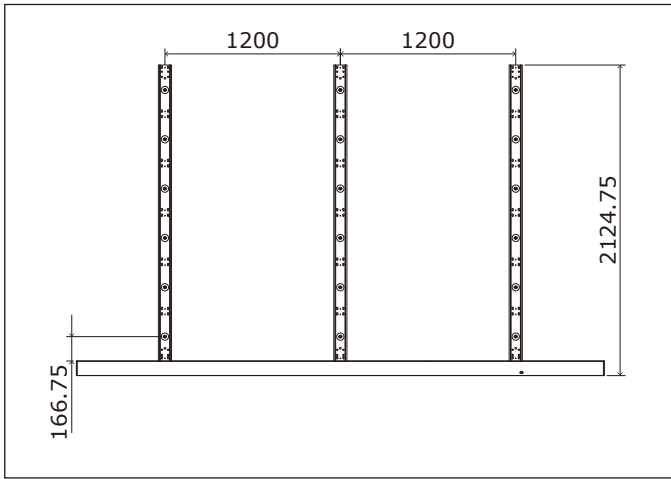

8 x 8 frame set

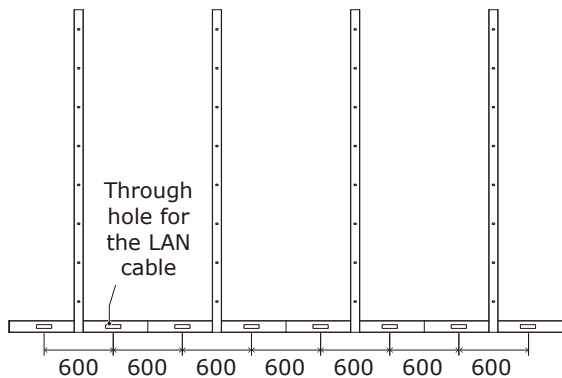
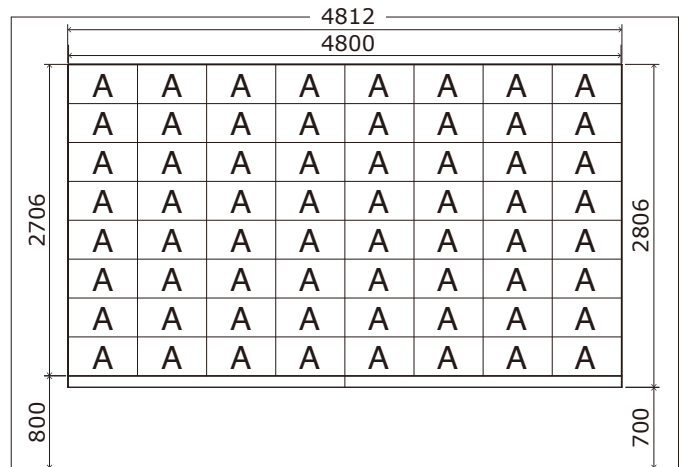
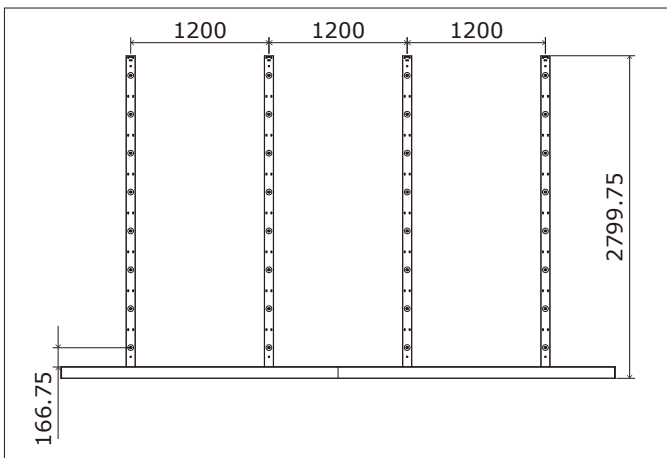

9. Installation without a frame set

A recommended example of installation when using the brackets is shown below. Please prepare the bracket by yourself. Ask a technician or your retailer for the installation procedure when not using the brackets.

Install the brackets to the frame as shown in the figure below.

Use screws with a length adapted to the cabinet thickness (13 mm). Use also brackets with a sufficient thickness to hold the screws.

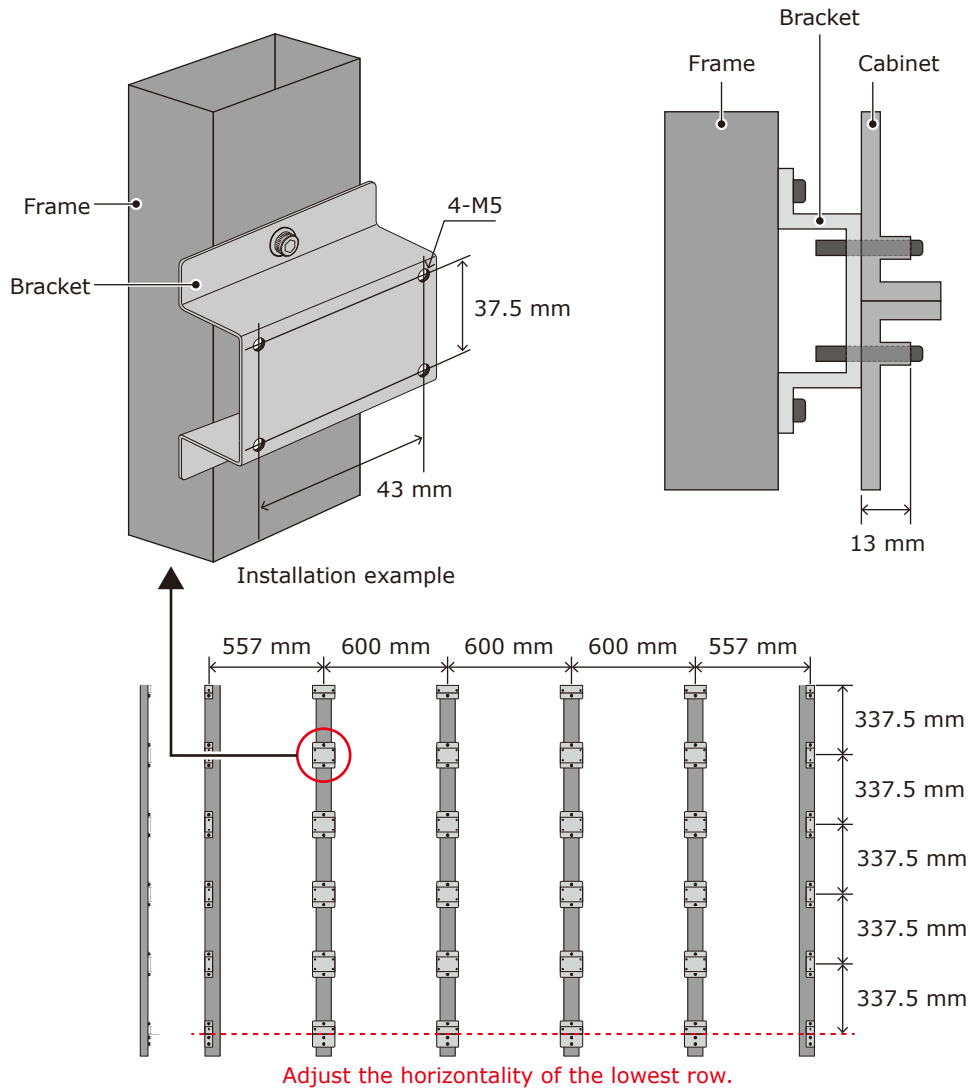

For installation, please refer to the "7. Install the cabinets".

10. Wiring

(1) Maximum number of signal connections

The maximum number of connections per LAN cable is shown below.

Product name	Maximum number of connections
LED-E012i	4 modules
LED-E015i	7 modules
LED-E018i	10 modules
LED-E025i	17 modules

CAUTION

The maximum number of connections may differ depending on the connected LED controller. Therefore, check the specifications of the LED controller you are using. Ask a technician or your retailer for more details.

(2) Maximum number of power connections

CAUTION

Exceeding the maximum capacity may generate smoke or cause a fire. Check the voltage used and do not exceed the connection limits shown below.

Except Taiwan, Korea and India:

Product name	100 - 120 V AC	200 - 240 V AC
LED-E012i	13 modules	25 modules
LED-E015i	13 modules	25 modules
LED-E018i	13 modules	25 modules
LED-E025i	13 modules	25 modules

For Taiwan, Korea and India:

Product name	100 - 120 V AC	200 - 240 V AC
LED-E012i	10 modules	20 modules
LED-E015i	10 modules	20 modules
LED-E018i	10 modules	20 modules
LED-E025i	10 modules	20 modules

(3) Connection when using a wall-mount frame

This connection is an example of connection when using the maximum capacity.

The power cable corresponding to the yellow part needs to be prepared by the customer.

Please connect considering the capacity of the switchboard and the inrush current specification.

4 x 4 frame set

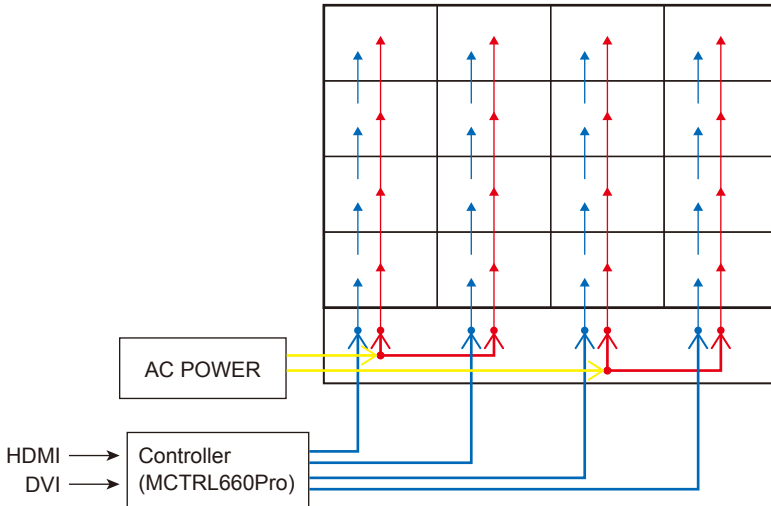

4x4 frame set		AC 100V	AC 200V
Number of power system		2	2
Current rating	per 1 module	1.5 A	0.8 A
	per power system	12.0 A	6.4 A
	per frame set	24.0 A	12.8 A
Inrush current 25°C Cold start Pulse width: 3ms	per 1 module	30 A	60 A
	per power system	240 A	480 A
	per frame set	480 A	960 A

5 x 5 frame set

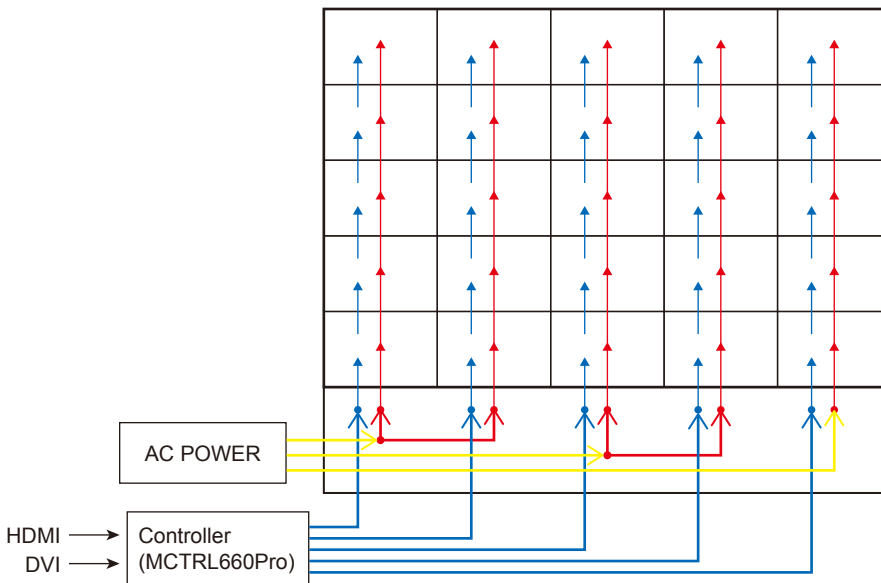

5 x 5 frame set		AC 100V	AC 200V
Number of power system		3	3
Current rating	per 1 module	1.5 A	0.8 A
	per power system	7.5 A (1 Systems) 15.0 A (2 Systems)	4.0 A (1 Systems) 8.0 A (2 Systems)
	per frame set	37.5 A	20.0 A
Inrush current 25°C Cold start Pulse width: 3ms	per 1 module	30 A	60 A
	per power system	150 A (1 Systems) 300 A (2 Systems)	300 A (1 Systems) 600 A (2 Systems)
	per frame set	750 A	1500 A

6 x 6 frame set

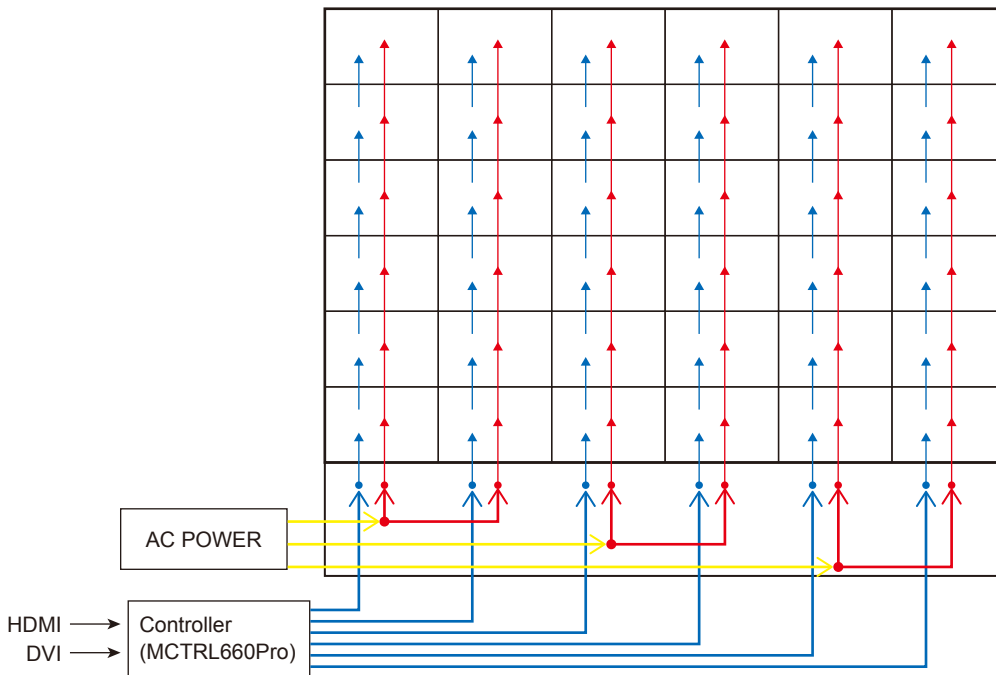

6 x 6 frame set		AC 100V	AC 200V
Number of power system		3	3
Current rating	per 1 module	1.5 A	0.8 A
	per power system	18.0	9.6 A
	per frame set	54.0 A	28.8 A
Inrush current 25°C Cold start Pulse width: 3ms	per 1 module	30 A	60 A
	per power system	360 A	720 A
	per frame set	1080 A	2160 A

8 x 8 frame set (1.2 mm pitch)

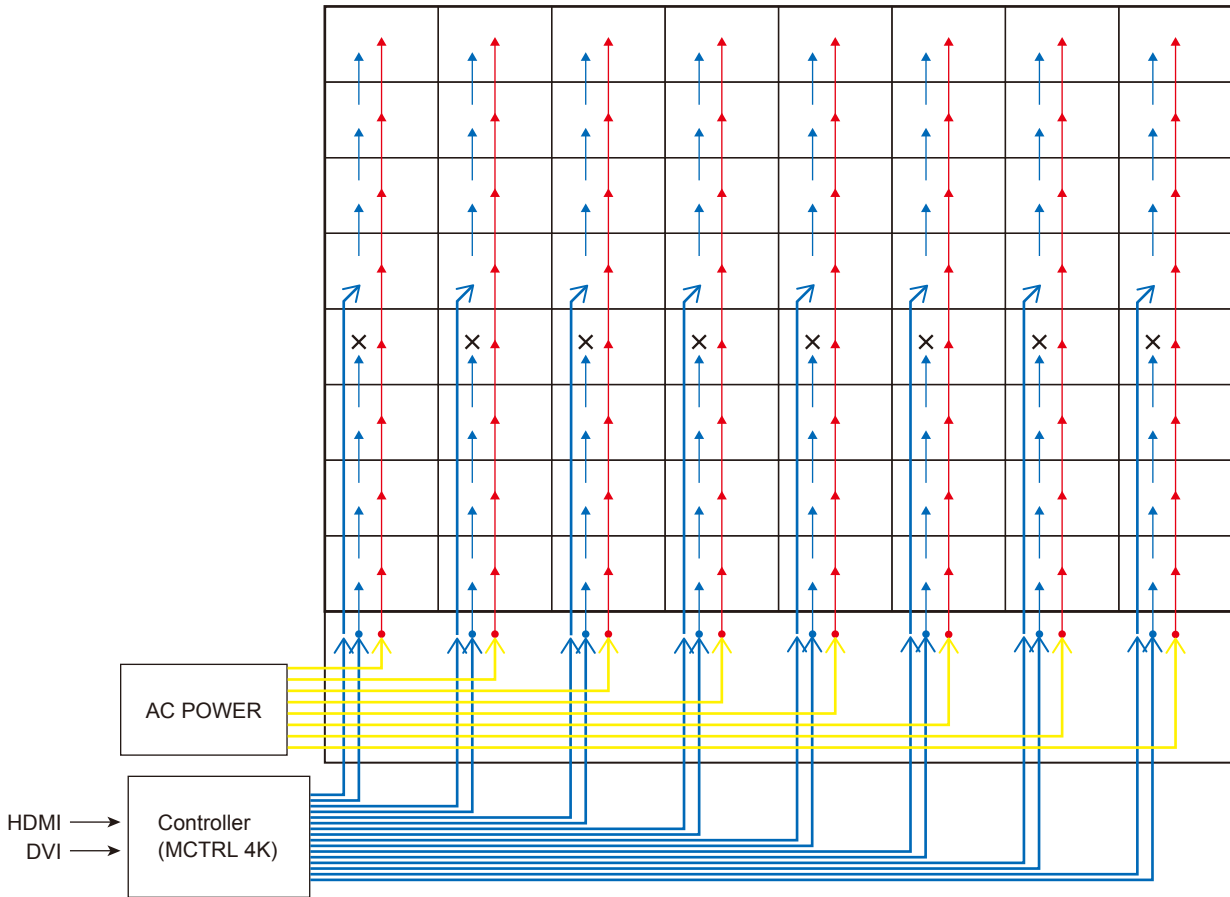

8 x 8 frame set (1.2 mm pitch)		AC 100V	AC 200V
Number of power system		8	8
Current rating	per 1 module	1.5 A	0.8 A
	per power system	12.0 A	6.4 A
	per frame set	96.0 A	51.2 A
Inrush current 25°C Cold start Pulse width: 3ms	per 1 module	30 A	60 A
	per power system	240 A	480 A
	per frame set	1920 A	3840 A

8 x 8 frame set (2.5 mm pitch)

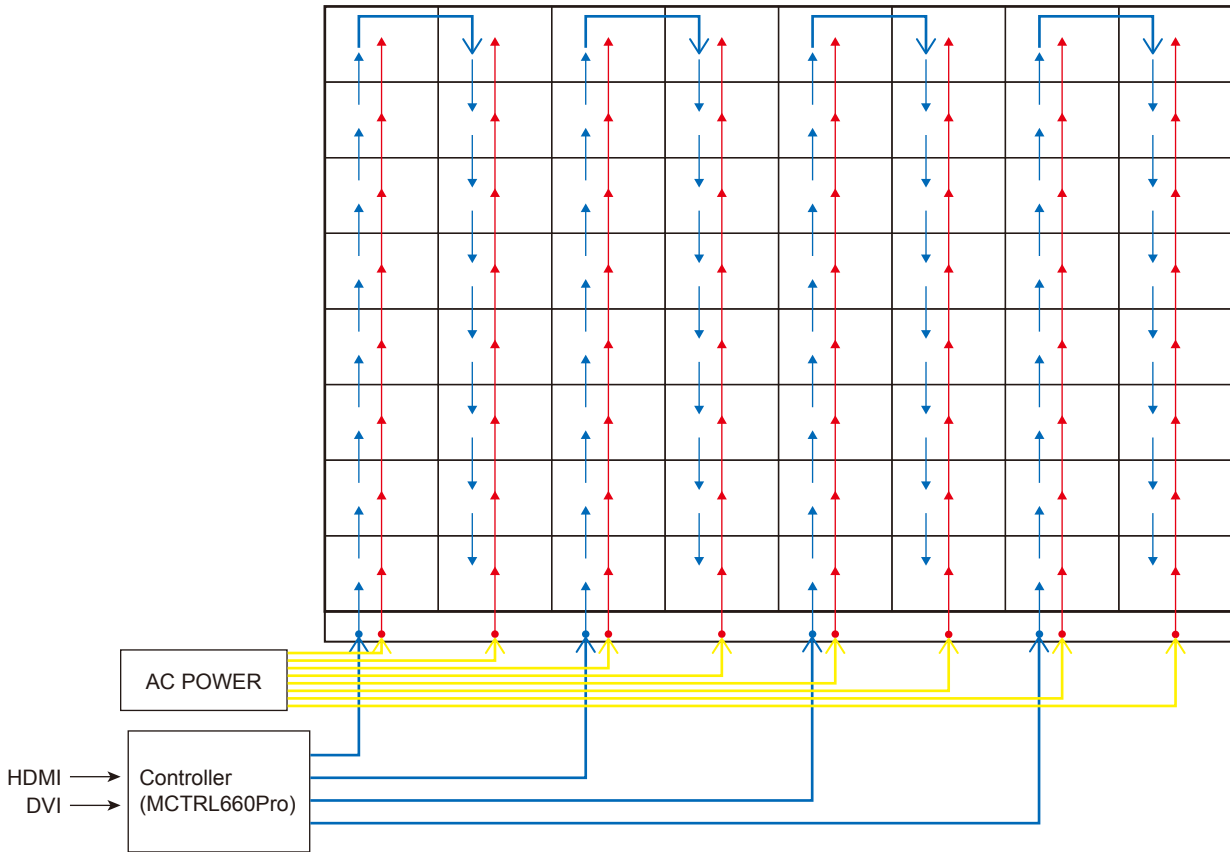

8 x 8 frame set (2.5 mm pitch)		AC 100V	AC 200V
Number of power system		8	8
Current rating	per 1 module	1.5 A	0.8 A
	per power system	12.0 A	6.4 A
	per frame set	96.0 A	51.2 A
Inrush current 25°C Cold start Pulse width: 3ms	per 1 module	30 A	60 A
	per power system	240 A	480 A
	per frame set	1920 A	3840 A

11. Installing the pixel card

CAUTION

- The pixel cards contain powerful magnets. If magnetic cards come close to the pixel cards, the data contained within may be damaged. Therefore, do not carry any magnetic card when installing the pixel cards.
- When installing the pixel cards, pay attention not to damage them against the pixel cards already installed or other objects. Otherwise, the video may not be displayed properly.
- Take measures against static electricity when installing the pixel card. Do not touch the LED display areas and the back of the pixel card.
- Check that the power supply to the LED modules is cut before starting the work.
- Before installing or removing pixel cards, please ensure the wall has been powered off for 1 or 2 hours. Otherwise the thermal expansion of pixel cards increases the risk of damaging them during removal or insertion.
- If installation is not successful, please use the maintenance tool. (see [English-55](#))

Install the pixel card to the cabinet paying attention that the arrows on the back of the pixel card and on the hub board are orientated toward the same direction, and that the two guide pins of the pixel card are aligned to the guide holes of the cabinet (two for each pixel card).

The pixel card is secured by the 14 magnets on each pixel card.

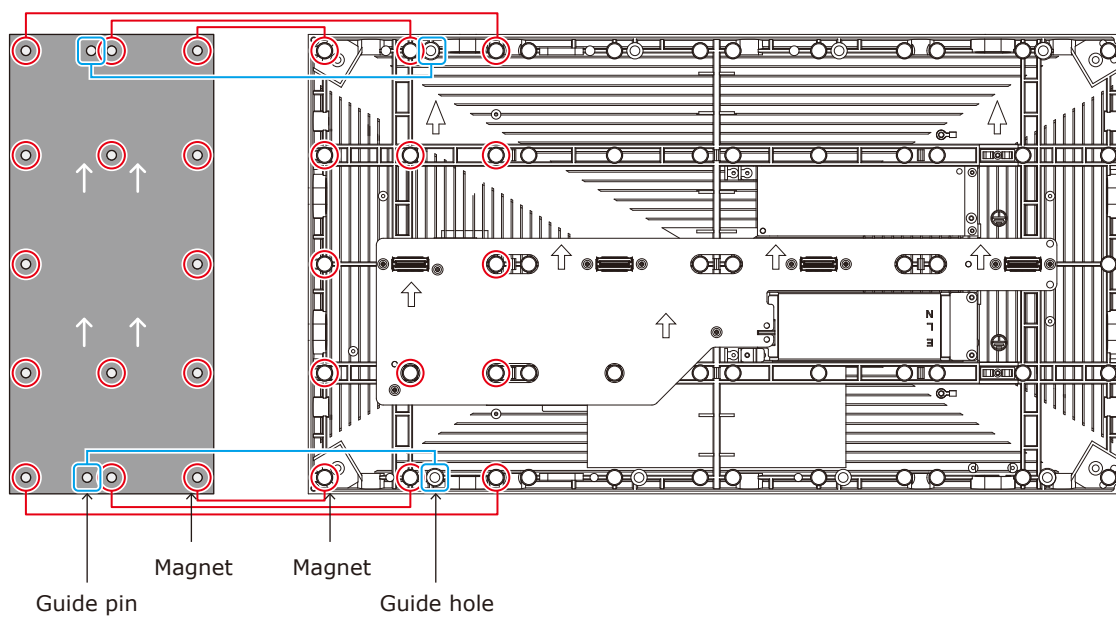

Screen Configuration

Check that all the connections are completed, and then turn on the LED modules and the LED controller.

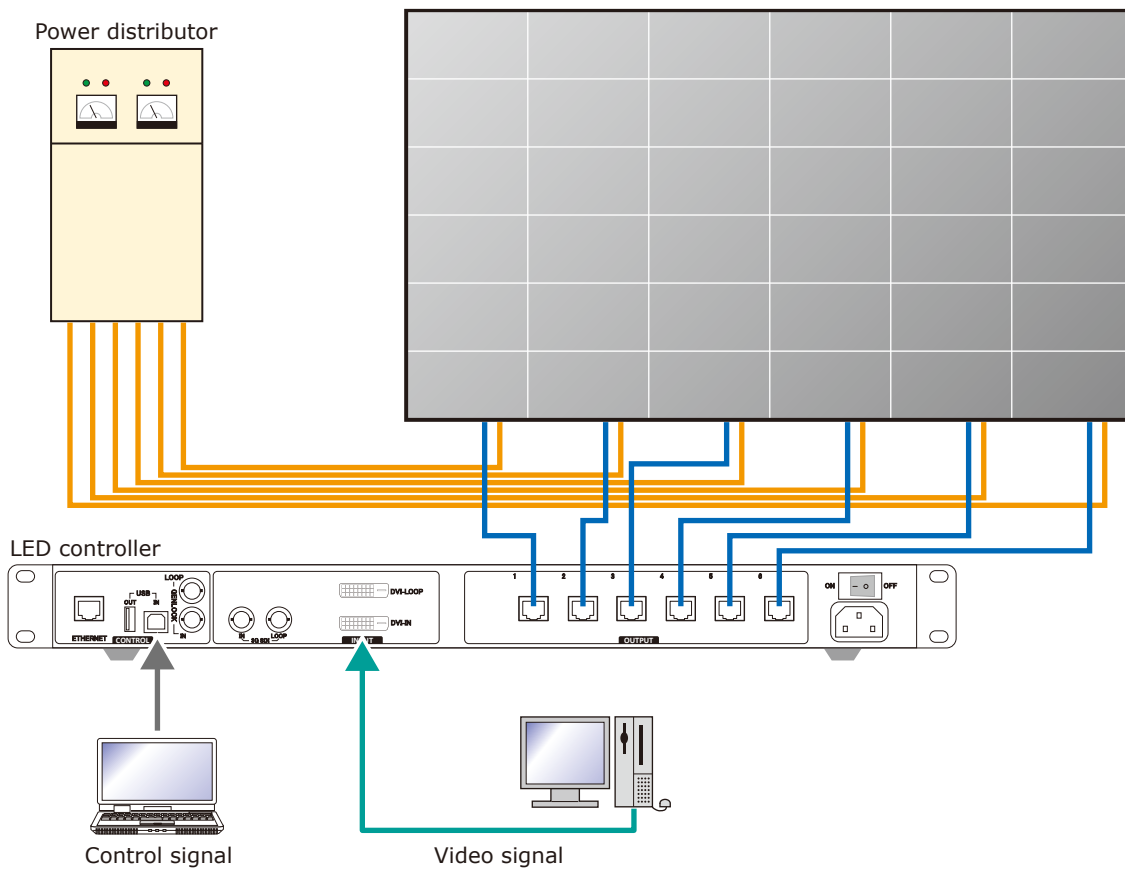

⚠ WARNING

Pay attention to the wire colors of the power cord when connecting the cord. If the cables are not connected correctly, it may lead to a fire or an electrical shock.

- Blue (N)
- Brown (L)
- Yellow green (Ground)

⚠ CAUTION

When using LAN cables of 60 m to 100 m in length, the product may not operate correctly depending on the quality of the cables. In such a case, it is recommended to use optical-fiber cables. Ask a technician or your retailer for more details.

Preparing for using NovaLCT software

Perform the setting using the NovaLCT control software by Novastar.
Connect the supplied USB memory to the computer. Start NovaLCT*.exe.
After it has started, install it following the software instructions.
The NovaLCT preparation is complete.

⚠ CAUTION

For NovaLCT*.exe, be sure to use the file contained in the supplied USB drive.
Using a NovaLCT*.exe file different than the one in the supplied USB drive may lead to malfunction.

Log in with the administrator privileges.
Display the login screen as follows: User(U) → Advanced Synchronous System UserLogin(A).
Enter the password ("admin" by default) to log in with the administrator privileges.
To change the password, go to User(U) → Change Password(U) with the administrator privileges.

⚠ CAUTION

Do not forget the new password after it has been changed.

Enter the screen configuration menu

(1) Click "Screen Configuration" (a).

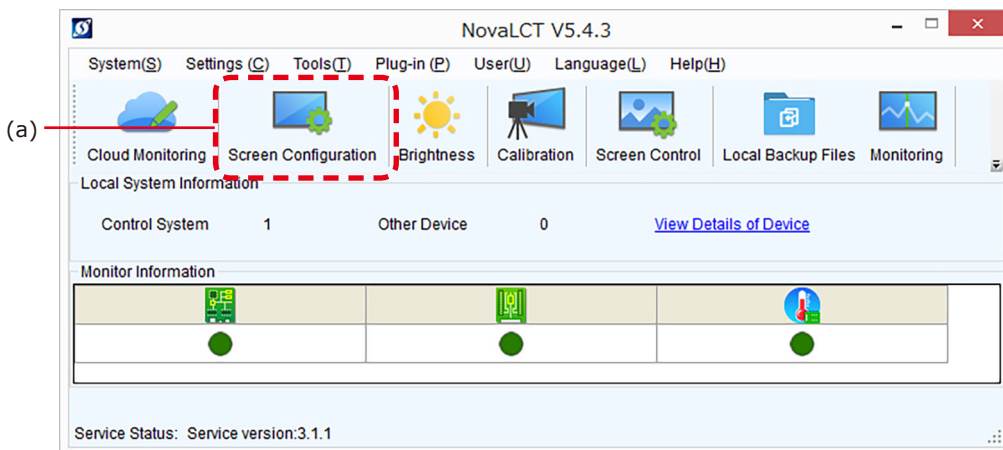

(2) Check the port in "Select Communication Port", and then click the "Next" button (b).

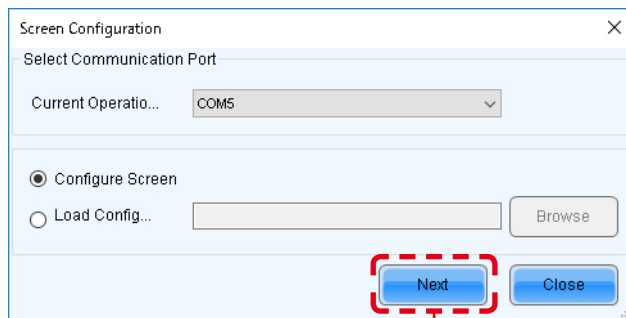

(b)

Module connection settings

Start NovalCT and log in with the administrator privileges.

In the Screen Configuration screen that is displayed, select the "Screen Connection" tab (a).

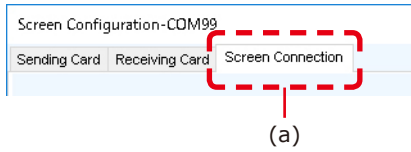

⚠ CAUTION

Do not change the settings in the "Receiving Card" tab. Otherwise, the video may not be displayed properly.

Select "Standard Screen" under "Screen Type" (b).

The settings in "Sending Card Number" (c) and "Ethernet Port No." (d) vary depending on the connected LED controller.

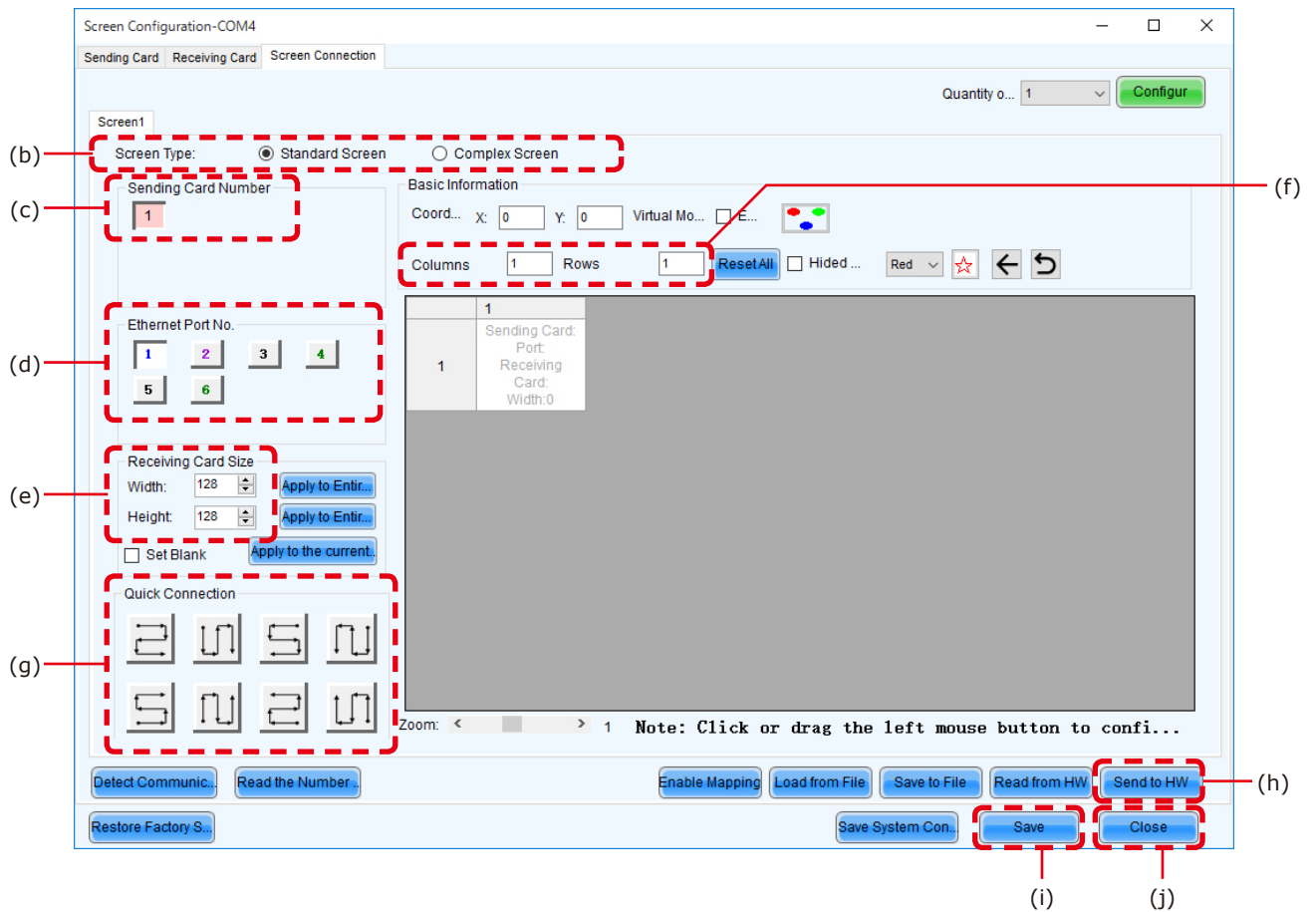

Enter the value in the table below under "Receiving Card Size" (e).

Product name	LED-E012i	LED-E015i	LED-E018i	LED-E025i
Pixel pitch	1.25 mm	1.56 mm	1.88 mm	2.50 mm
Number of displayed pixels (resolution/module)	Width 480 Height 270	Width 384 Height 216	Width 320 Height 180	Width 240 Height 135

[Columns/Rows] Enter the number of installed screens under "Columns/Rows" (f) (the number of vertically installed screens in Columns, and the number of horizontally installed screens in Rows).

[Configuration example]

The setting values are given for the following example where 16 are installed in a 4 (columns) x 4 (rows) configuration connecting from bottom to top using multiple ports.

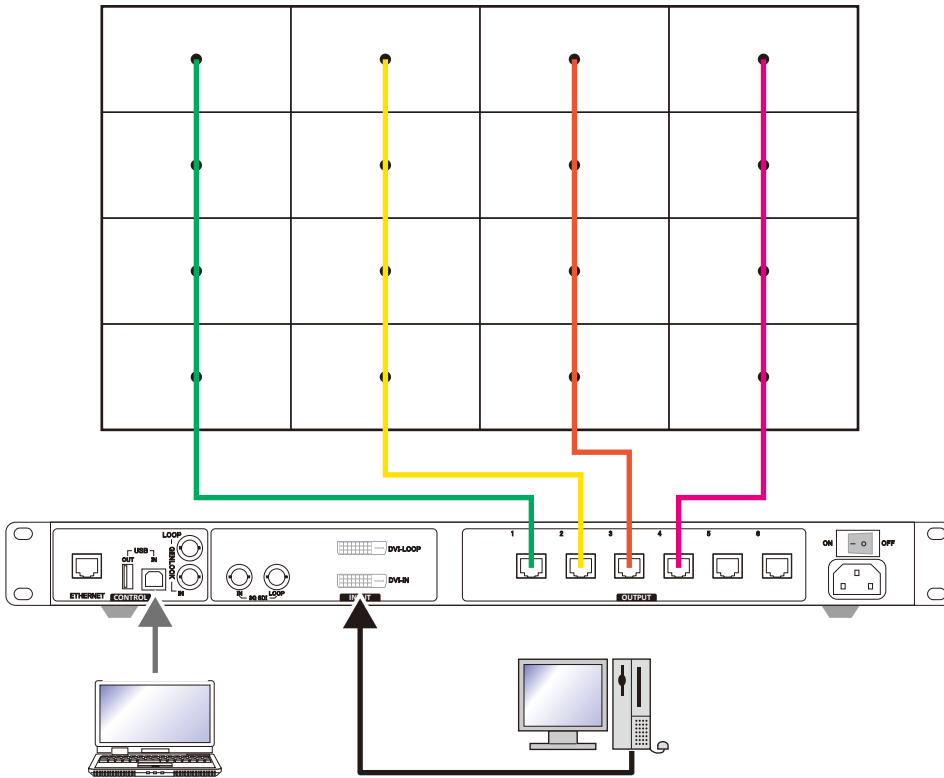

- (1) With a pixel pitch of 1.25 mm, enter Width=480 and Height=270 under "Receiver Card Size" (e). Do not use the buttons located next to the values.

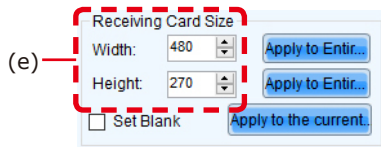

- (2) Since the configuration is 4 (columns) x 4 (rows), enter Columns=4 and Rows=4. A 4 (columns) x 4 (rows) screen configuration is displayed.

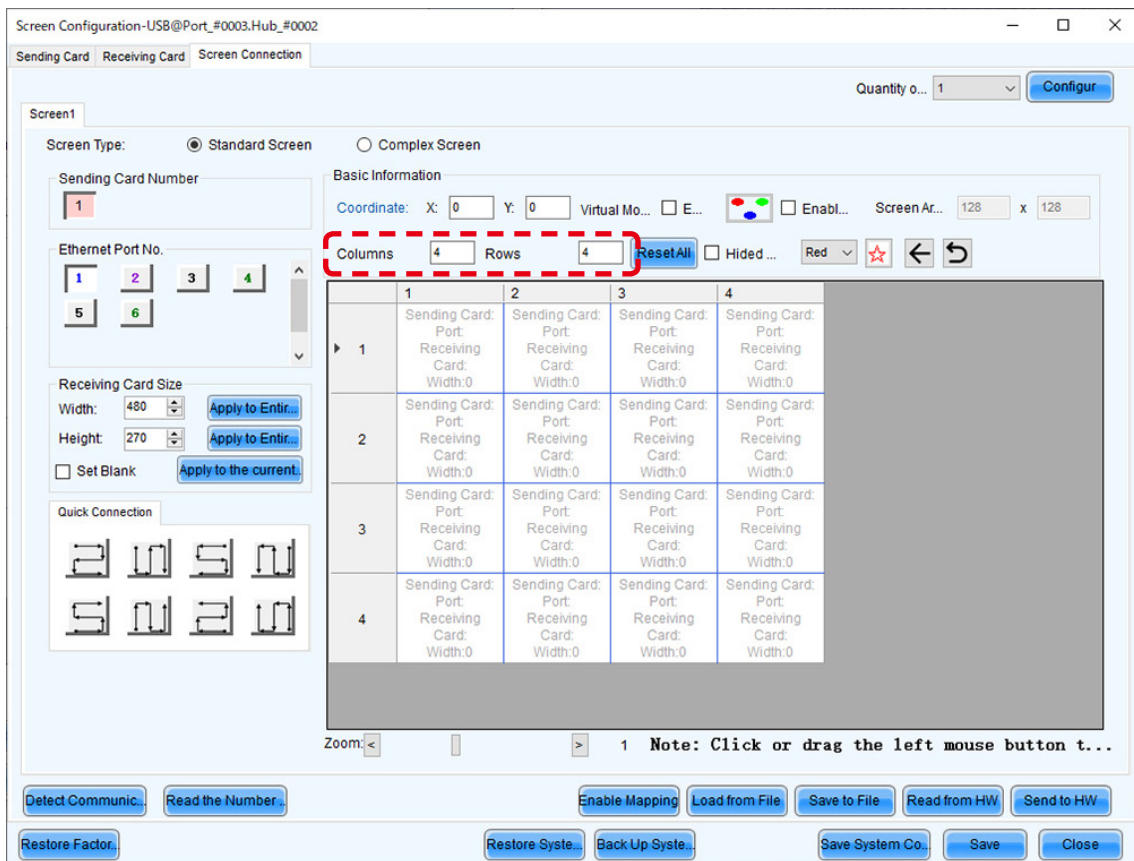

- (3) If multiple LED controllers are used, select the number of the connected LED controllers. Since only one controller is used in this example, it is not necessary to set "Sending Card Number" (c).

- (4) Configure the connection.

The system is connected to port 1 of the LED controller.

Select "1" (port 1) under "Ethernet Port No." (d).

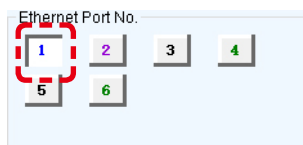

Select the cabinet at the bottom left with the mouse, and then select the other cabinets up to the top cabinet.

Then select Port2 and select the cabinets from the bottom to the top as you did for Port1.

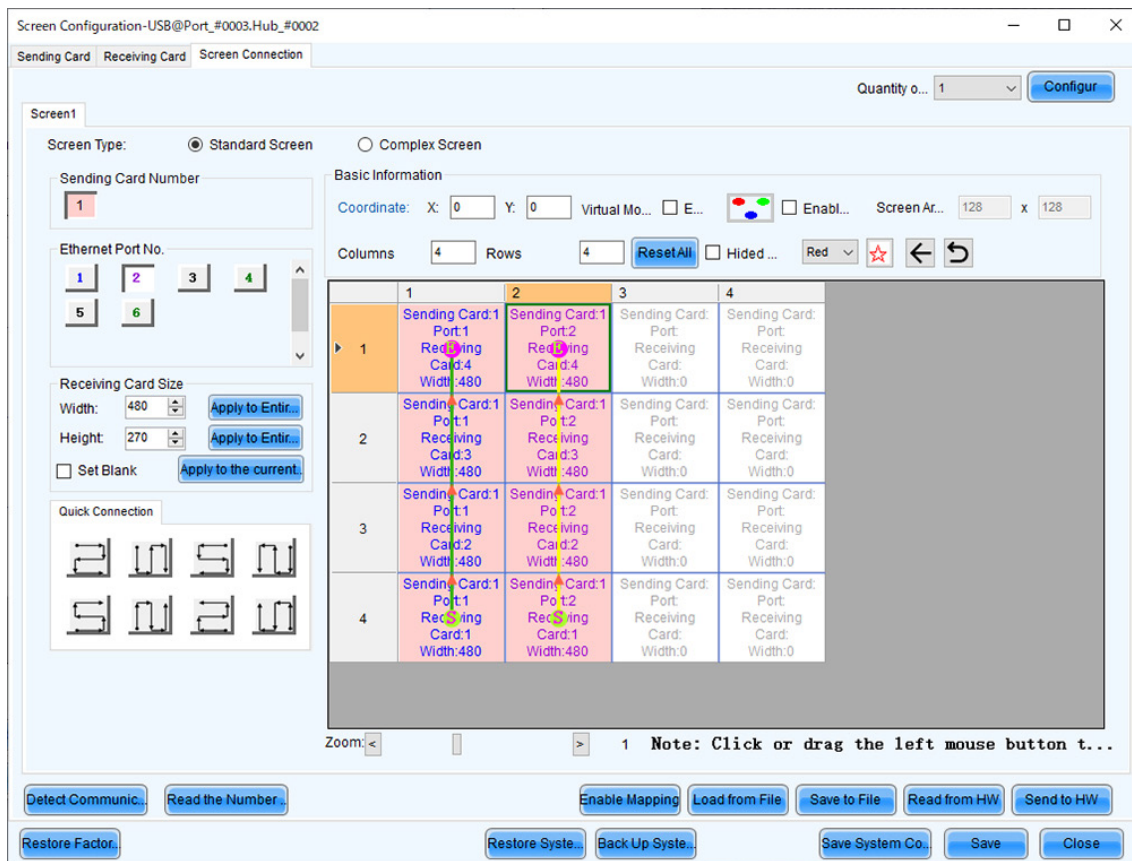

Follow the same procedure for Port3 and Port4.

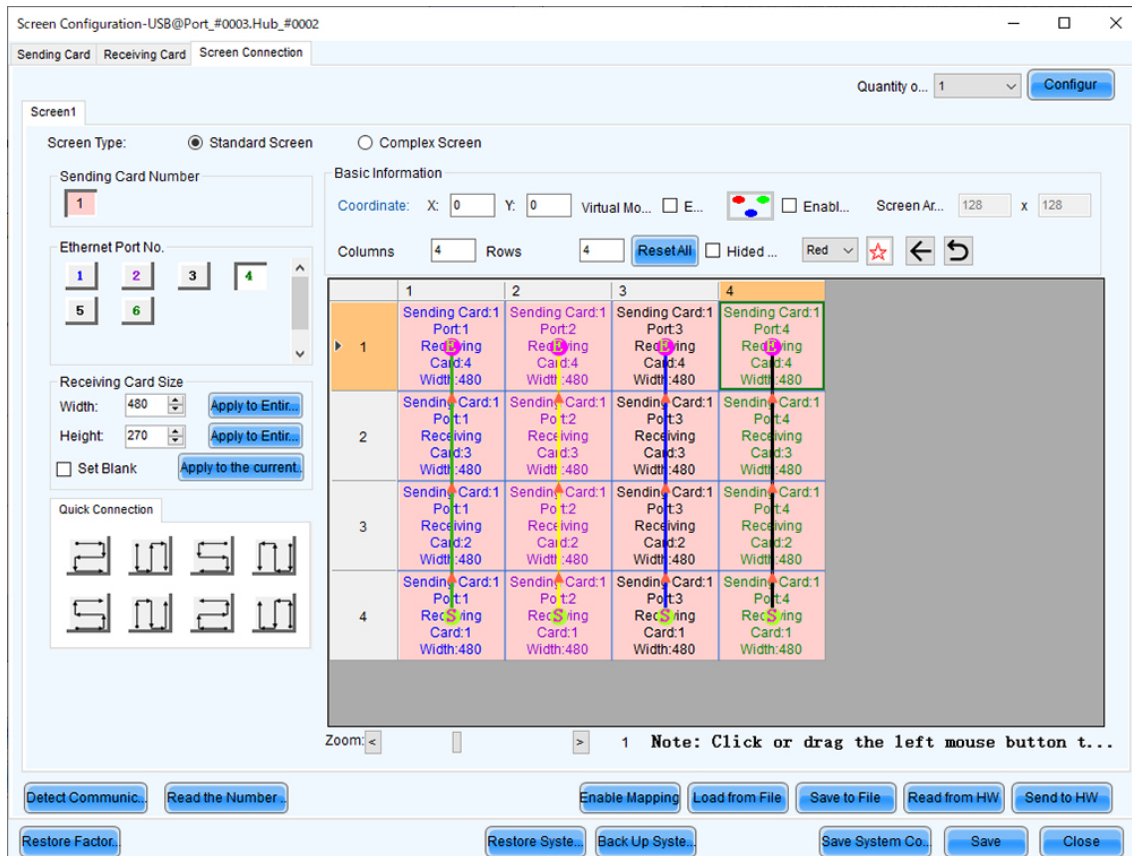

(5) Save the settings.

- (a) Click the "Send to HW" button (h). When the dialog box indicating that the process finished successfully is displayed, click OK.
- (b) Check that the image is correctly displayed, and then click the "Save" button (i). When the screen indicating that the process finished successfully is displayed, click OK.

The setting of the screen configuration is complete. Click the "Close" button (j) to close the Screen Configuration screen.

Receiving card settings

(1) The Screen Configuration screen is displayed. Select the "Receiving Card" tab (a).

(a)

(b)

(c)

(d)

(2) Click "Load from File" (b).

(3) Select the configuration file (rcfgx file) you want to load to the receiving card. A screen like the following appears when the loading process is complete.

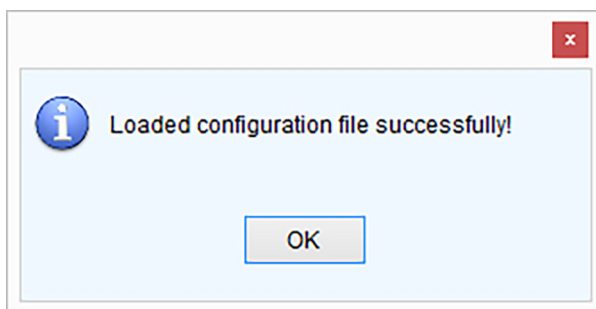

(4) Click "Send to Receiving Card" (c).

(5) Click "Save" (d). Loading of the configuration file is complete.

Update the Calibration Data

- (1) Login as Advanced User.
- (2) Click the "Calibration" button (a). Start calibration menu.

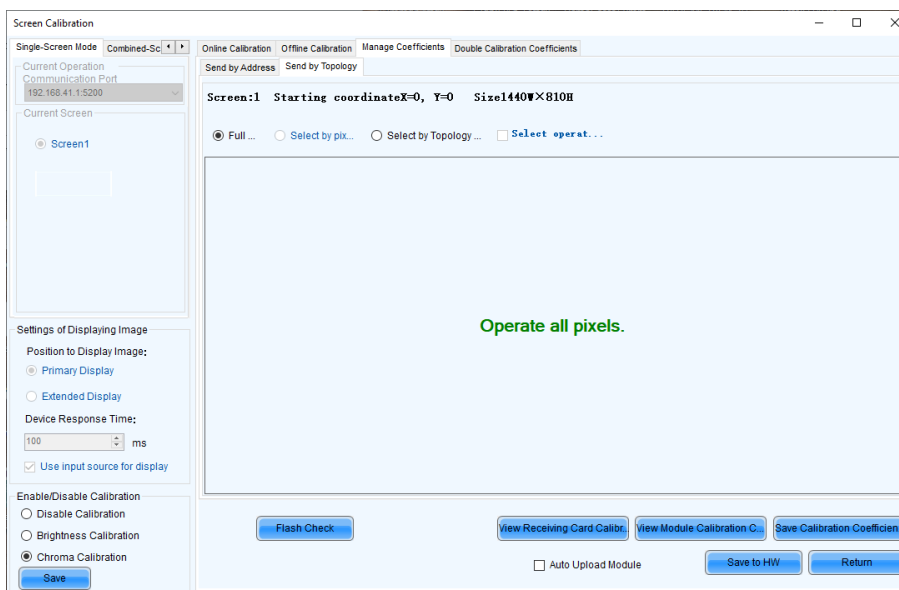
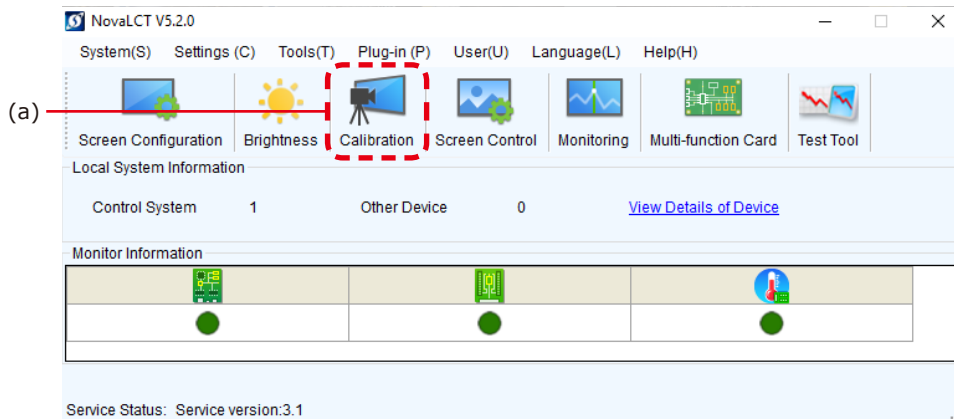

- (3) Select the "Screen1" radio button.
- (4) Click on the "Manage Coefficients" tab (b).

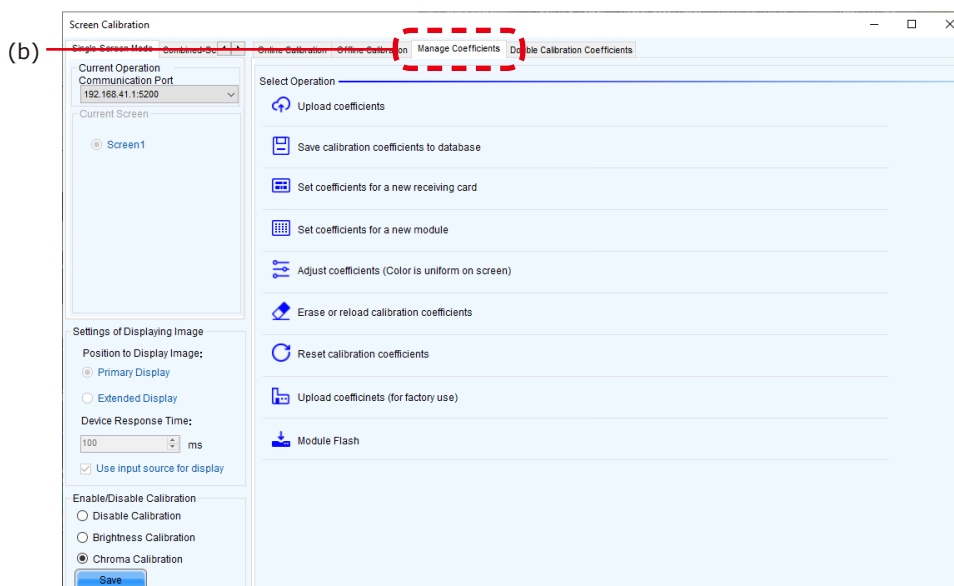

- (5) Click on "Module Flash".
Result: The module flash options will appear.

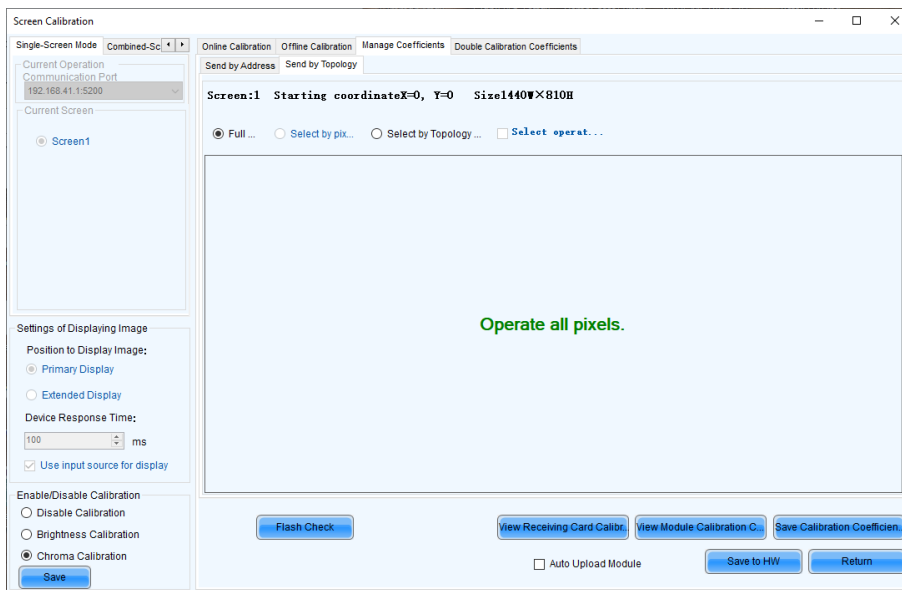

Select whether you want the entire screen or individual modules.

Full screen: Select this option when installing.

Module Flash (Select by Topology or list): Select this option when replacing pixel cards, etc.

If "Line calibration" or "Adjusting the colors on a part of the screen" has been performed on the area set for Module Flash, please perform it again after Module Flash.

- (6) Click the "View Module Calibration Coefficients" button.
Result: Pop-up message opens.

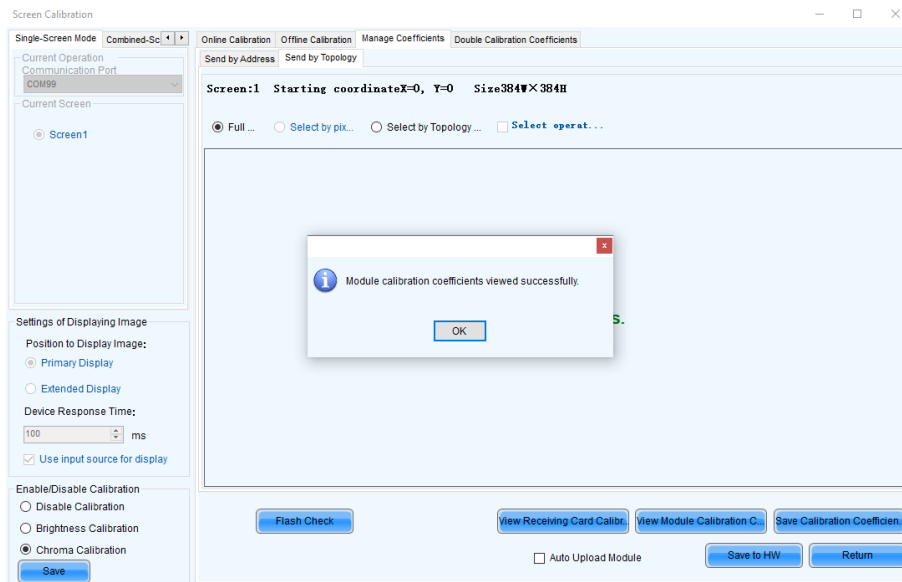

(7) Click "Save Calibration Coefficients to Receiving Card".

The pop-up message, that the data has been successfully stored to the Receiving cards, will appear.

Result: The screen with the exchanged Pixel cards should look calibrated now.

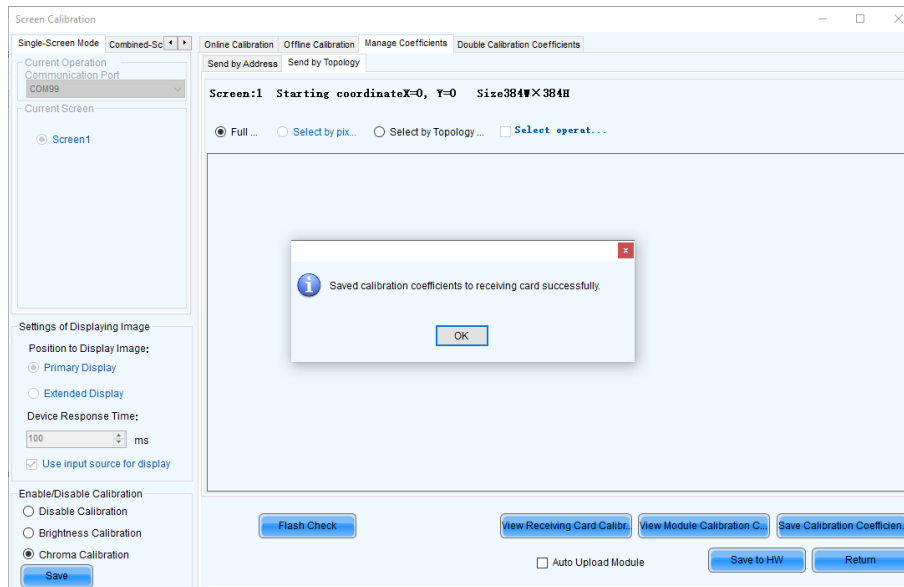

(8) Click on "Save to HW" button and go back to main window by clicking "X" button.

(9) Check the calibration-state in the bottom left corner of Screen Calibration window: Enable/Disable Calibration.

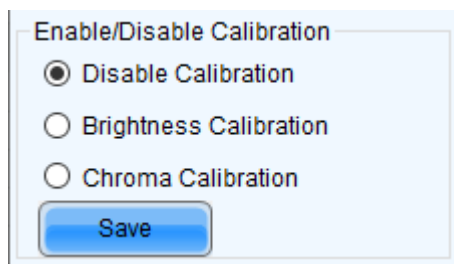

(10) If calibration-setting "Disable Calibration" is chosen, switch to "Chroma Calibration" (c) to enable calibration and click on the "Save" button (d).

Result: While switching you will already see calibration effect.

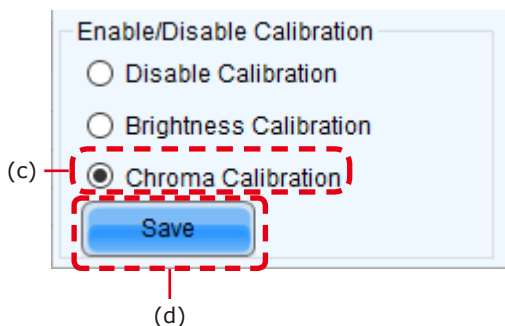

(11) Close Screen Calibration windows by clicking on the "X".

Result: The Screen Calibration has been finished for both screens.

Image Setting

You can adjust the brightness, the gamma correction value, and the color temperature.

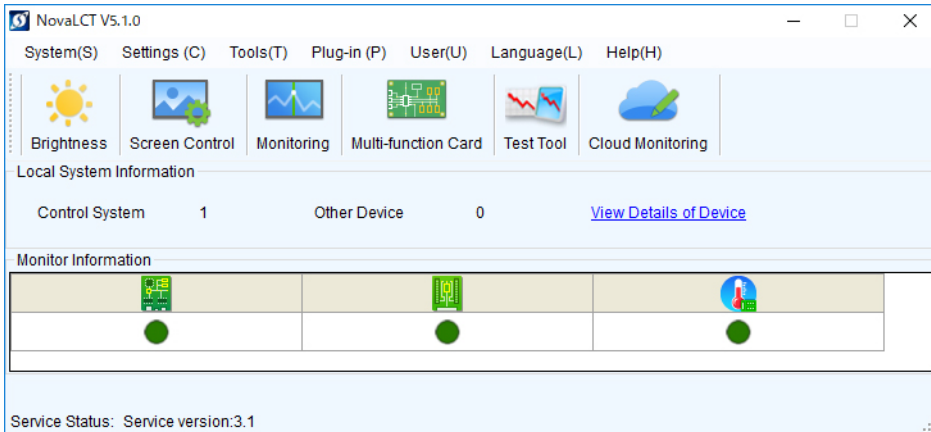

Click "Brightness" on the top screen to display the following window.

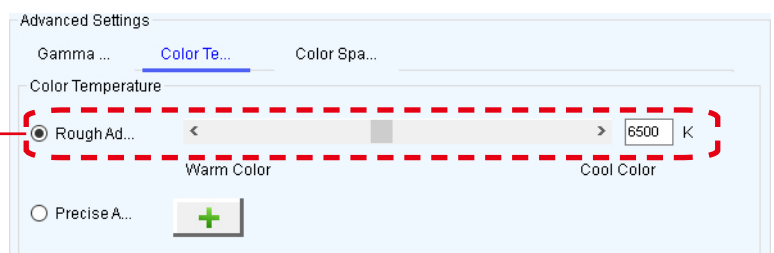
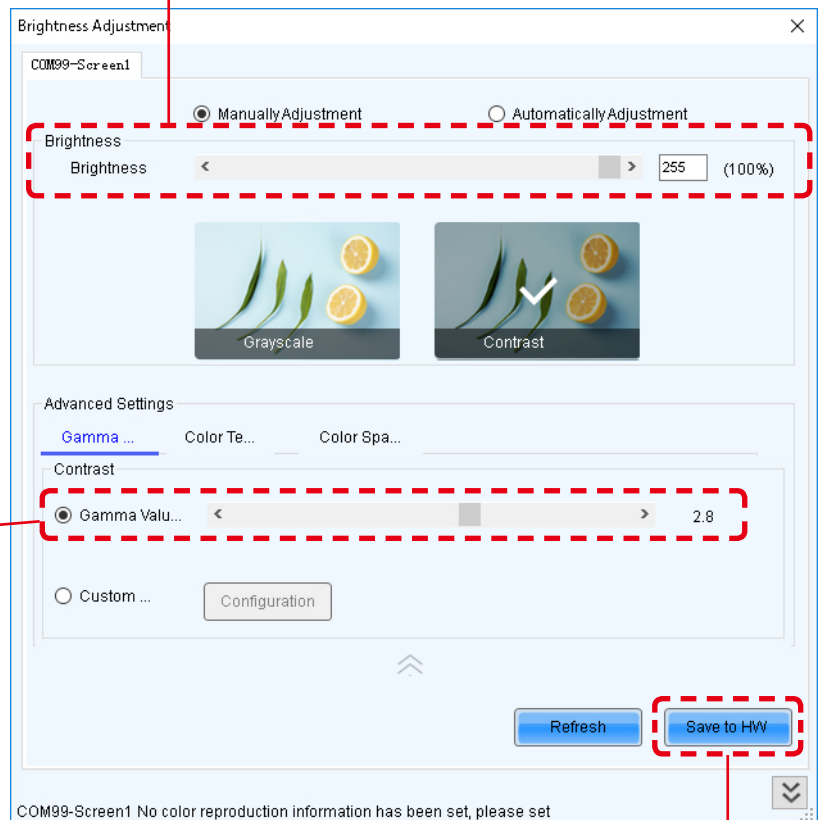
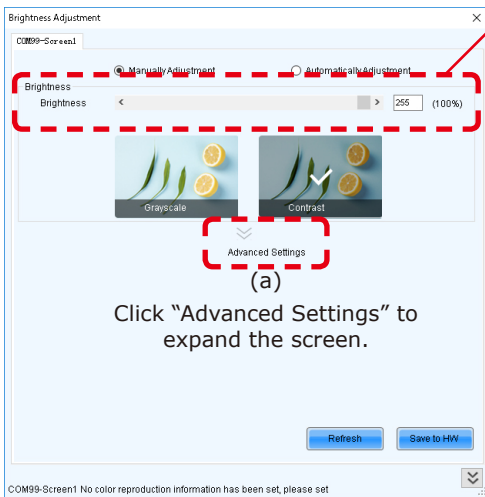

Click "Advanced Settings" (☒) (a) to expand the setting screen.

(1) Brightness

Set the brightness of the screen using the slider (b).
Increasing the value increases the brightness.

(2) Gamma correction

Set the gamma correction value using the slider (c).
Increasing the value makes the dark parts of the screen darker.

(3) Color temperature

Set the color temperature using the slider (d).
Increasing the value makes the colors more bluish, while reducing the value makes the colors more reddish.
When the setting is complete, click the "Save to HW" button to save the settings.

Line calibration

- (1) Log in with the administrator privileges ([English-40](#)).
- (2) On the tabs at the top of the window, click Tools > Quickly Adjust Dark or Bright Lines > Adjust Dark or Bright Lines

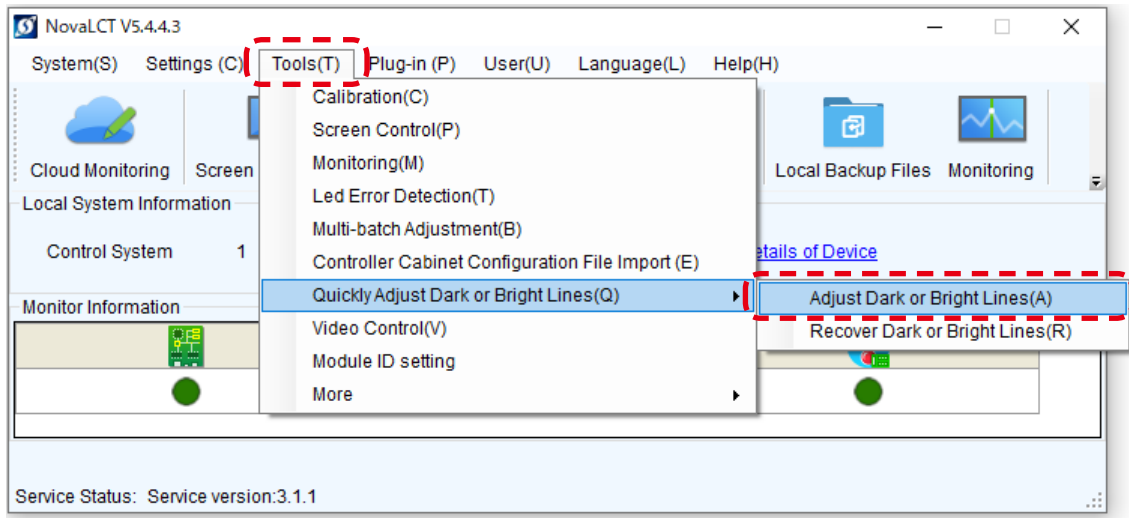

- (3) Click the "Quickly Adjust (New)" button on the right of the window that pops up.

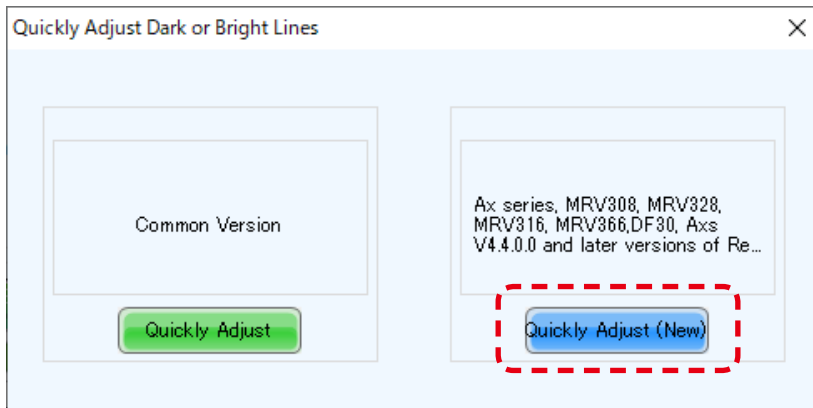

- (4) A screen like the figure below is displayed. Press the Shift + E keys. The gray window moves to the LED modules.

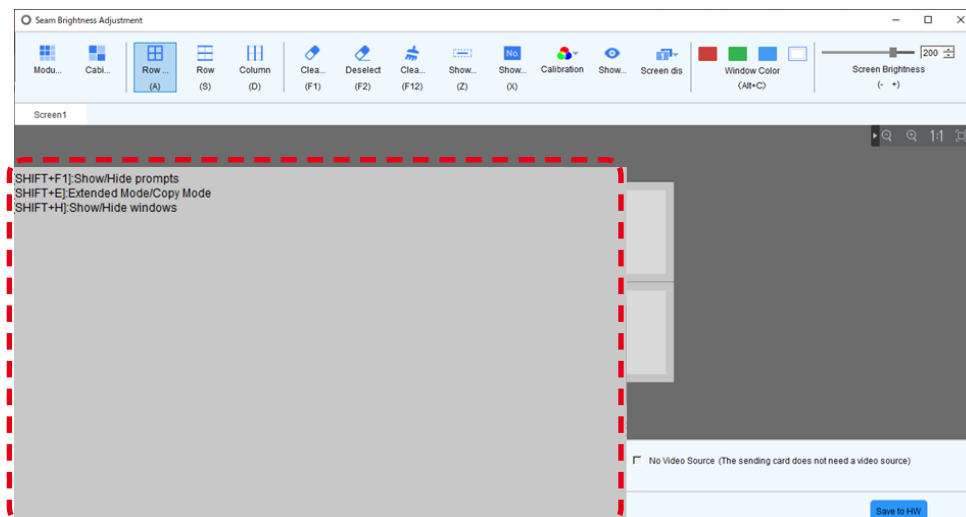

(5) Click "Module Mode" on the top left of the screen.

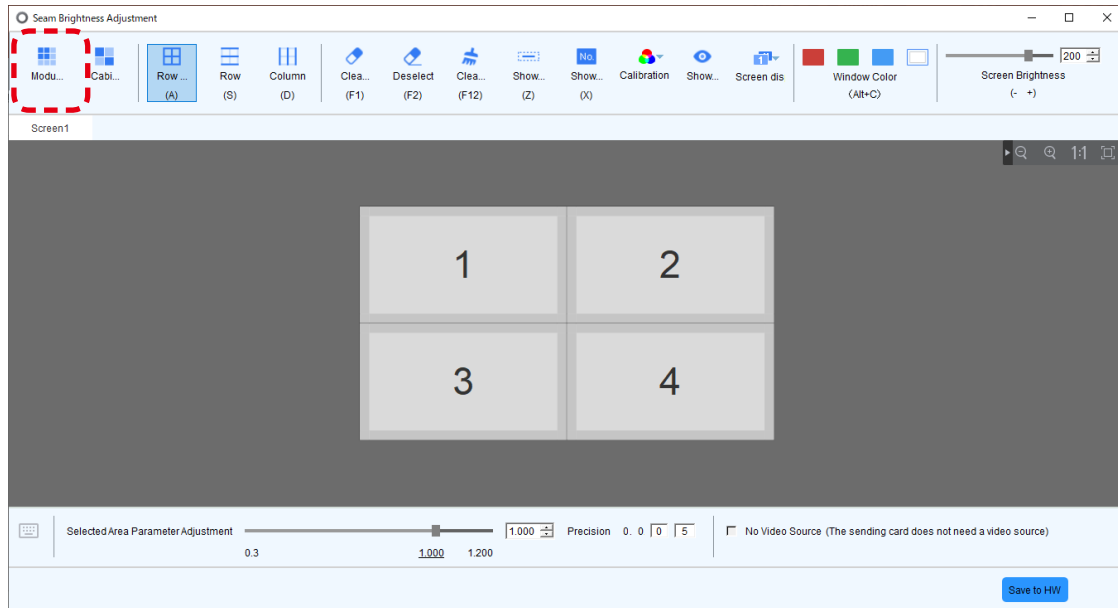

Enter the number of pixel cards inside one module on the screen that pops up, and then click "OK".

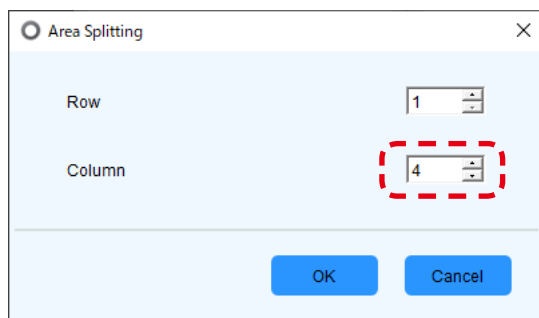

Lines separating each pixel card are displayed.

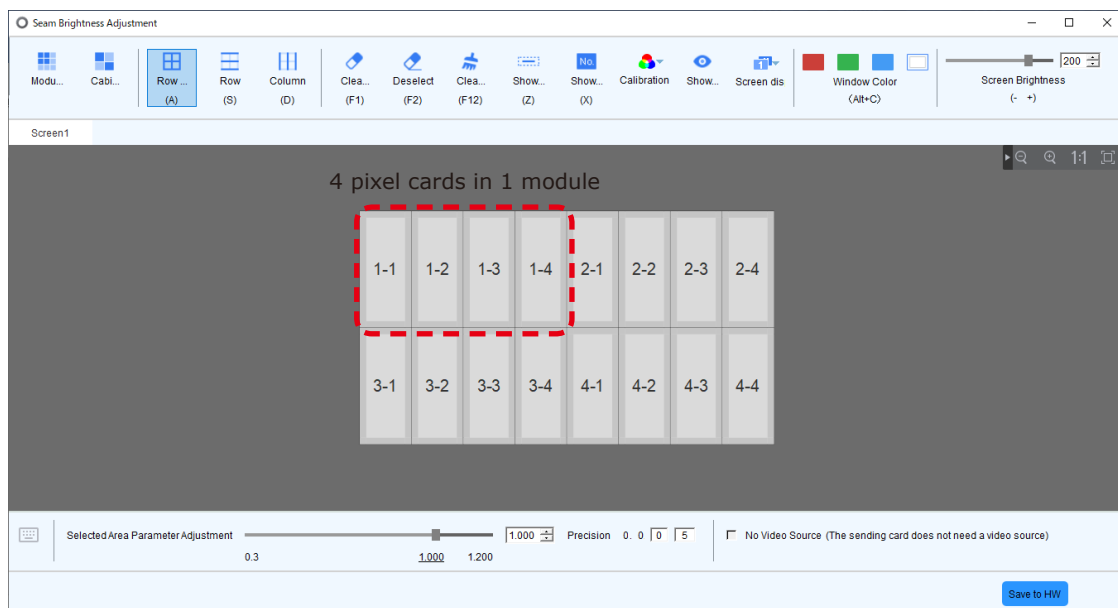

(6) Specify the border between the pixel cards for which you want to perform line calibration by clicking on it or specifying a range. You may also adjust multiple locations at the same time.

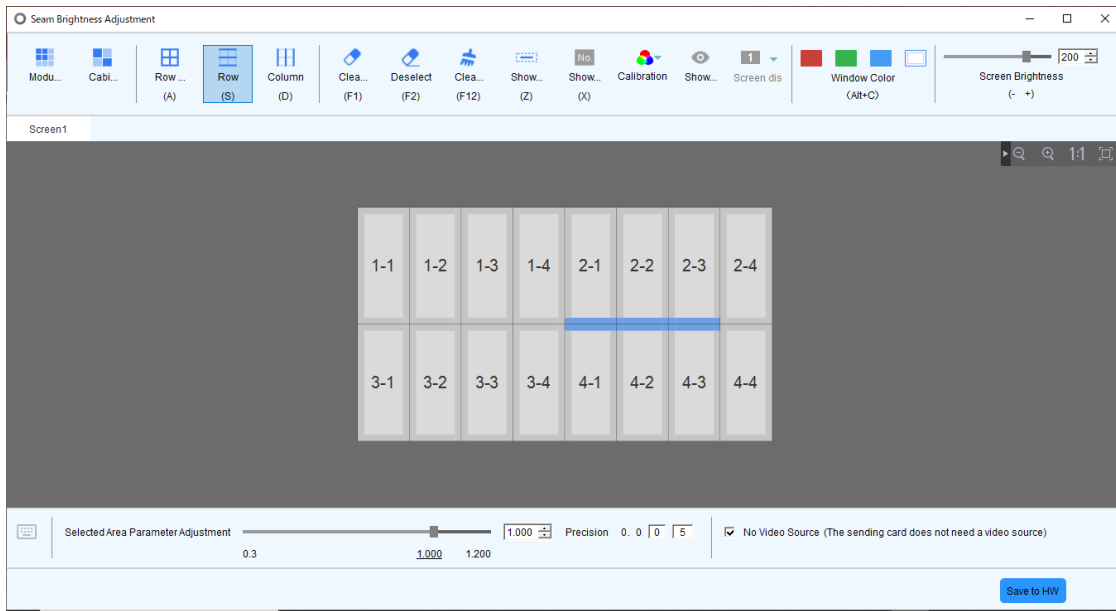

< Tool icons used to select the adjustment range >



Clear effects: Resets the line calibration in the selected range.



Deselect: Deselects the range currently selected.



Clear all effects: Resets line calibration for all locations.

The selected adjustment range is also displayed on the LED modules.

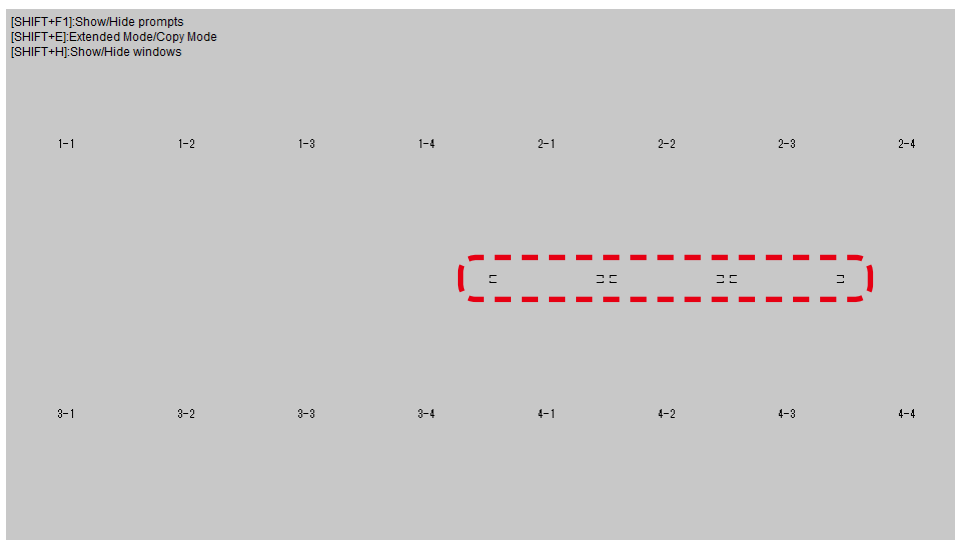

- (7) Click the upward and downward arrows next to the input box at the bottom of the window to adjust the brightness of the selected locations.

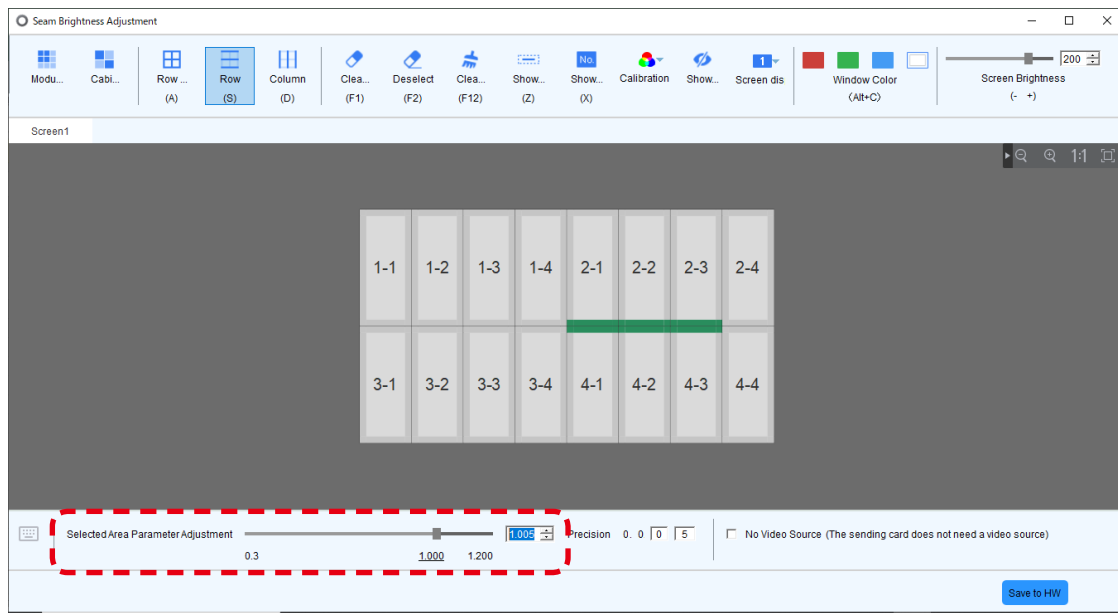

Upward arrow: Increases the brightness (makes the dark lines less noticeable)
 Downward arrow: Decreases the brightness (makes the bright lines less noticeable)

- (8) If you want to adjust other locations, click "Deselect" and specify again a range for the adjustment. When the adjustment is complete, click "Save to HW" at the bottom of the screen.

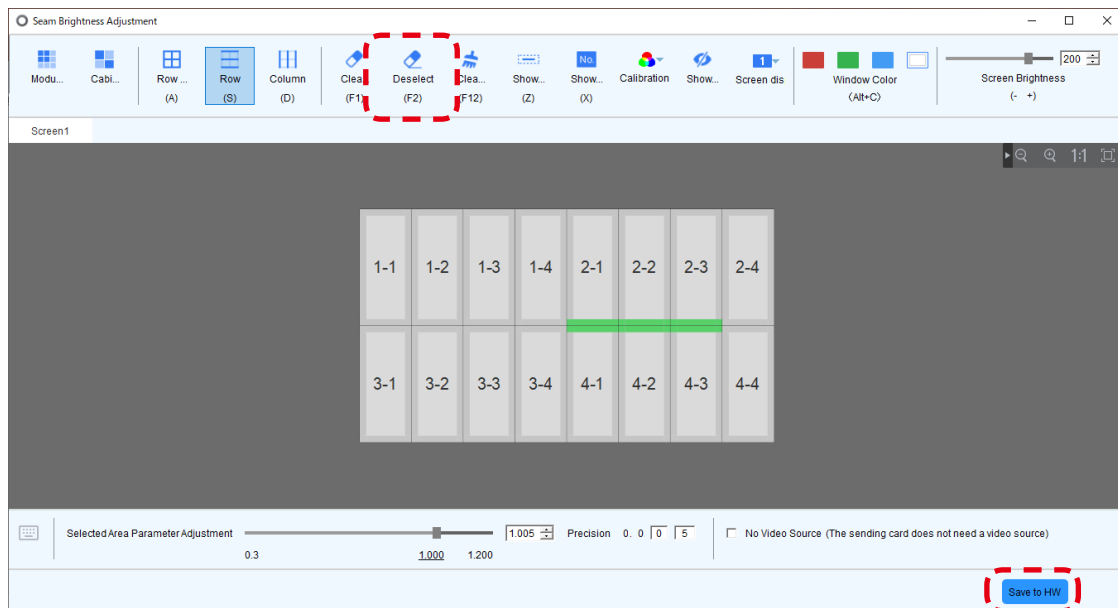

Click "Yes" on the screen that pops up.

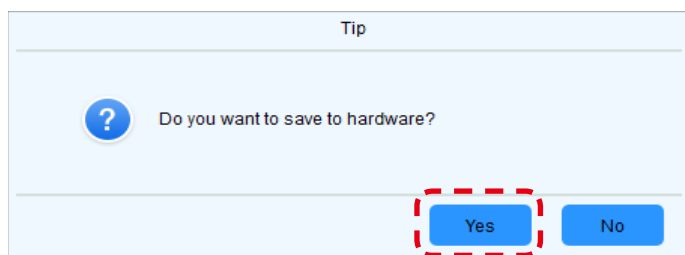

(9) The adjustment is complete when the following screen is displayed. Click "Close" to finish.

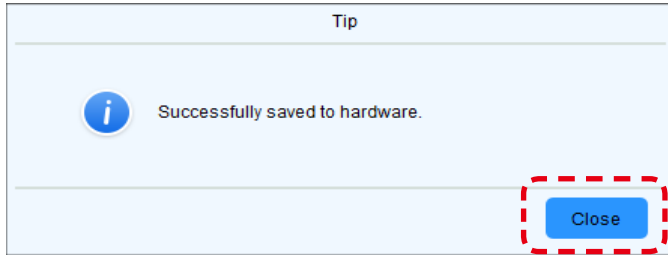

Cleaning

The screen brightness may decrease if dust or another foreign material is adhering to the surface of the pixel card.

The magnet used to install the pixel cards also attracts magnetic metal particles, such as iron powder.

Therefore, magnetic metal particles may adhere to areas near the magnet of the pixel card and the brightness homogeneity of the screen may decrease.

Cleaning should be performed regularly depending on the installation environment.

Required tools (example).

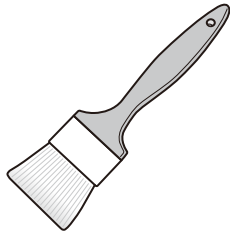

Soft brush

(animal hair brush to prevent static electricity)

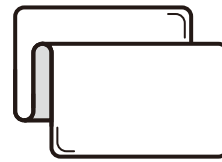

Soft cloth

(that does not generate static electricity)

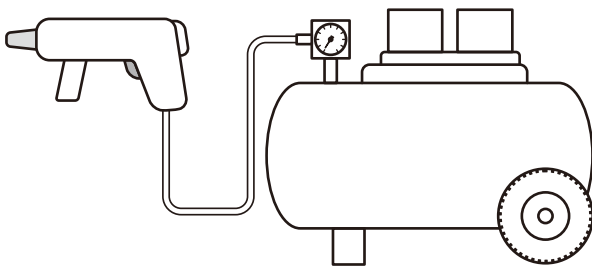

Air blower (compressor)

Cleaning method

- a) Turn the LED displays off.
- b) Use the soft brush to remove any dirt on the LED lamps and the masks. If these parts are very dirty, use the air blower to remove the dirt.
- c) Use the soft cloth to remove the dirt on the screen surface.
- d) Repeat the steps (b) and (c) to remove all the dirt.

CAUTION

- Do not use water or any other liquid.
- Do not use a stiff brush.
- Pay attention not to damage the LED lamps when using the soft brush, the air blower, or the soft cloth.

Maintenance

CAUTION

- Disconnect the power supply to the LED modules when performing the maintenance.
- Before installing or removing pixel cards, please ensure the wall has been powered off for 1 or 2 hours. Otherwise the thermal expansion of pixel cards increases the risk of damaging them during removal or insertion.
- Use the correct screwdriver for the shape of the screws when removing (loosening) or setting (tightening) the screws.
Pay attention not to drop the screws and the other parts you have removed.
Pay attention not to lose the removed screws since they will be reused.

Removing a pixel card

Remove the pixel card using the maintenance tool.

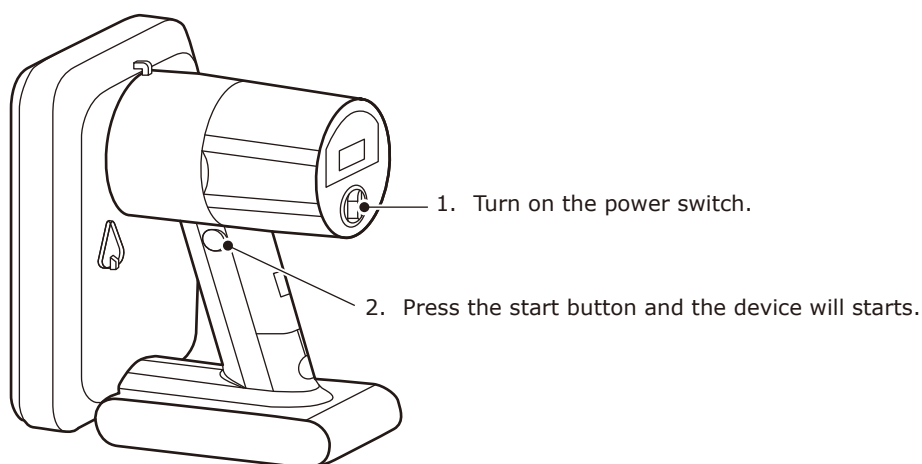

3. Put the maintenance tool flat onto the surface of the pixel card which you want to take off, make sure the device is tightly sucked with the pixel card.

4. Pull out the maintenance tool and pixel card vertically.

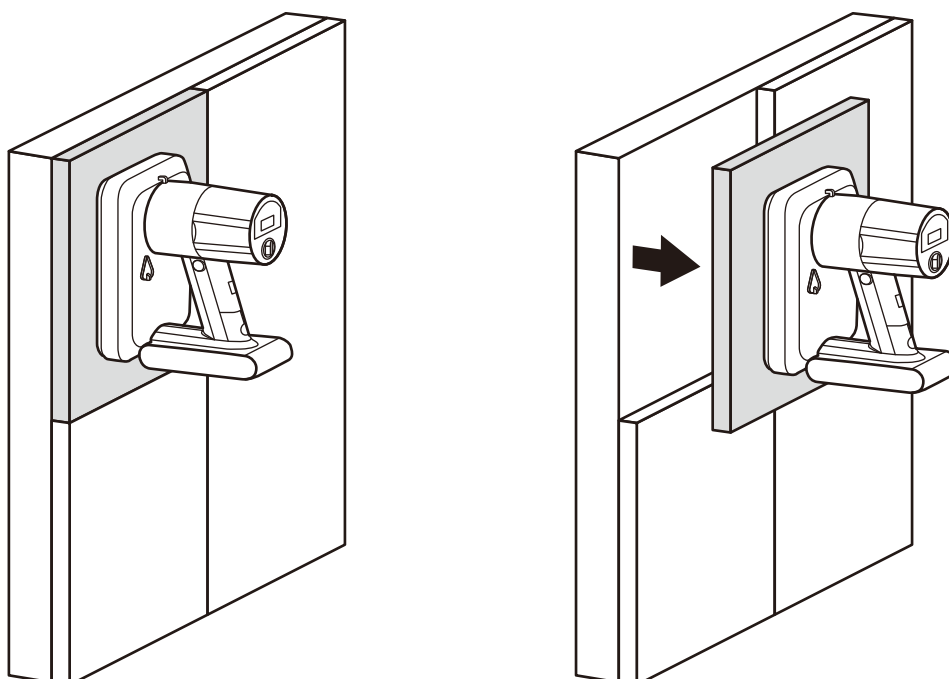

 **CAUTION:**

- Check that the battery of the maintenance tool is fully charged before starting the work. Pixel card falls if the battery runs out. Hold the pixel card with your hand to support in case it falls.
- Do not turn the maintenance tool off until you hold the pixel card. Otherwise, the pixel card may fall and break.

Removing the power supply

Disconnect the LAN cable connected to the hub board.

Remove the 10 screws securing the hub board, and then remove the hub board. Then, remove the two screws securing the terminal cover.

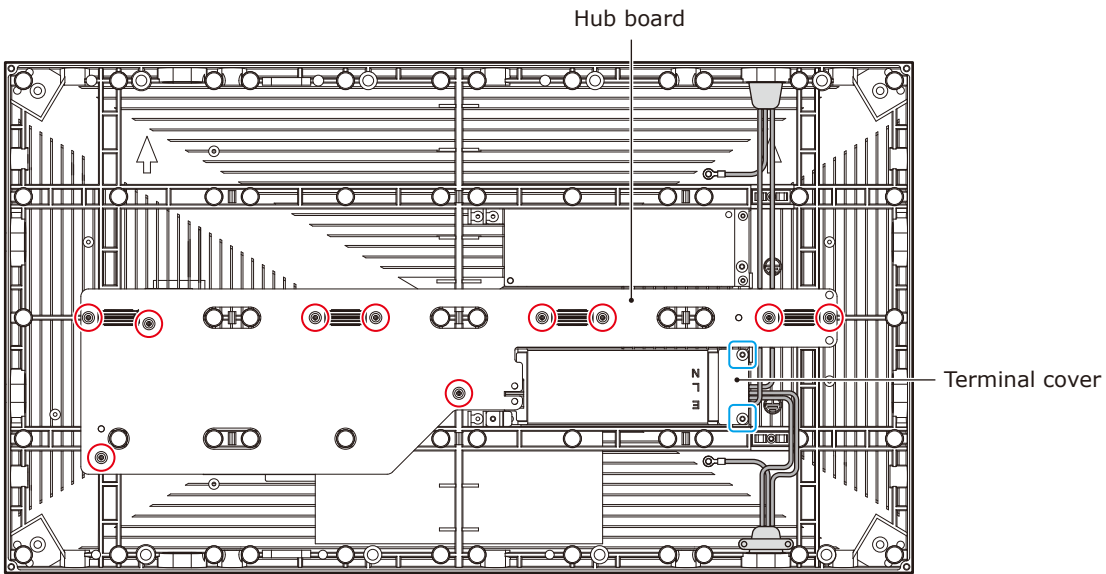

Disconnect the power cables connected to the power supply and remove the two screws securing the power supply, and then remove the power supply.

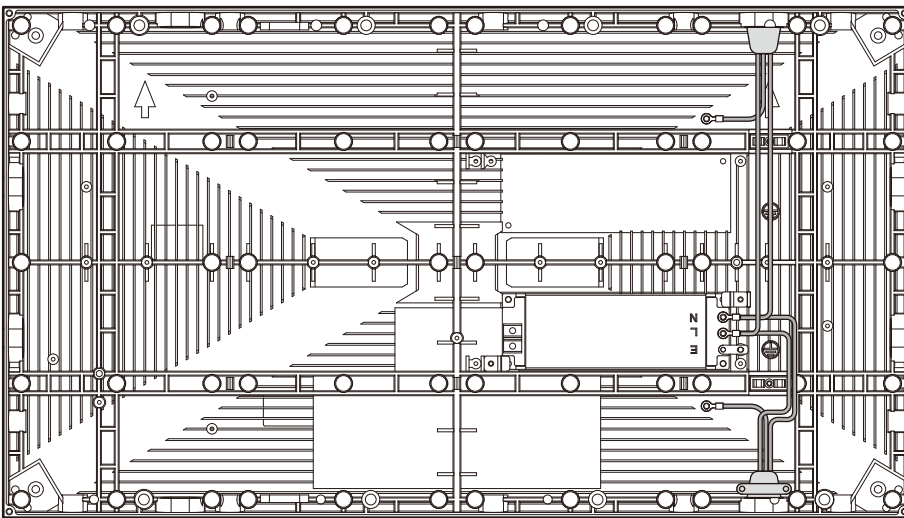

The power supply installation is done by following the same procedure in the reverse order.

Apply some thermal paste on the back of the power unit you will install before installing it. Ask your retailer for more details on the types of thermal paste.

⚠ CAUTION:

When attaching two cables with one screw, place the ring terminals of the cables back to back.

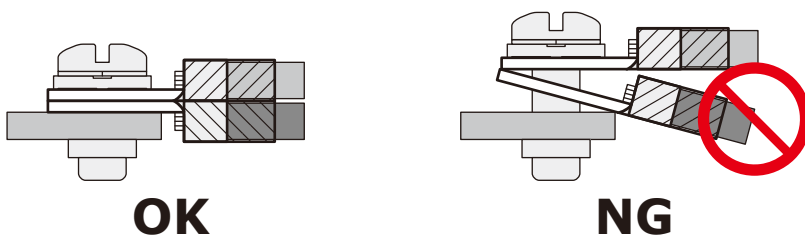

Removing the receiving card

Remove the receiving card from the hub board.

Remove the four screws securing the receiving card, and then remove the receiving card from the hub board.

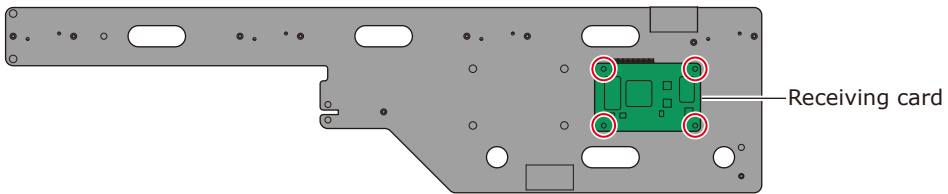

Troubleshooting

1. Display problems

Problem	Solution
Nothing is displayed on all the LED modules.	Check that power is being supplied to the LED modules.
	Check that the LED controller is turned on.
	Check that a video signal is being input to the LED controller.
	Check that a LAN cable is correctly connected between the LED controller and the LED module.
	Check that the brightness is not set to 0% (= not lit).
Nothing is displayed on one LED module.	Check that a LAN cable is correctly connected between the LED controller and the LED module.
	The receiving card inside the LED module may be broken. → Check the status of the LED module by following the procedure in the next section "2 State monitoring using the software".
	The power unit inside the LED module may be broken. → Check the status of the LED module by following the procedure in the next section "2 State monitoring using the software".
No image is displayed on one pixel card.	Check that the contacts of the pixel card are correct (contacts of the hub board).
	The pixel card may be broken. Replace it with a spare pixel card.
Control (communication) is not possible.	Check that the communication cable is correctly connected between the computer and the LED controller.
	Check that the LED controller is turned on.
	If the communication cable is a USB cable, check that the device driver runs correctly.
The colors differ on one pixel card.	Perform the "Adjusting the colors on a part of the screen" procedure. Select the adjustment range using "Select by Pixel Area" described in (5)-2.
I want to adjust the color tone of the entire screen.	Perform the "Adjusting the colors on a part of the screen" procedure. Select the adjustment range using "Screen" described in (5)-1.
Bright lines or dark lines are visible between the pixel cards or between the modules.	Perform the "Line calibration" procedure.

2. Adjusting the colors on a part of the screen

- (1) Log in with the administrator privileges (English-44).
- (2) Click "Calibration" (a). Start calibration menu.

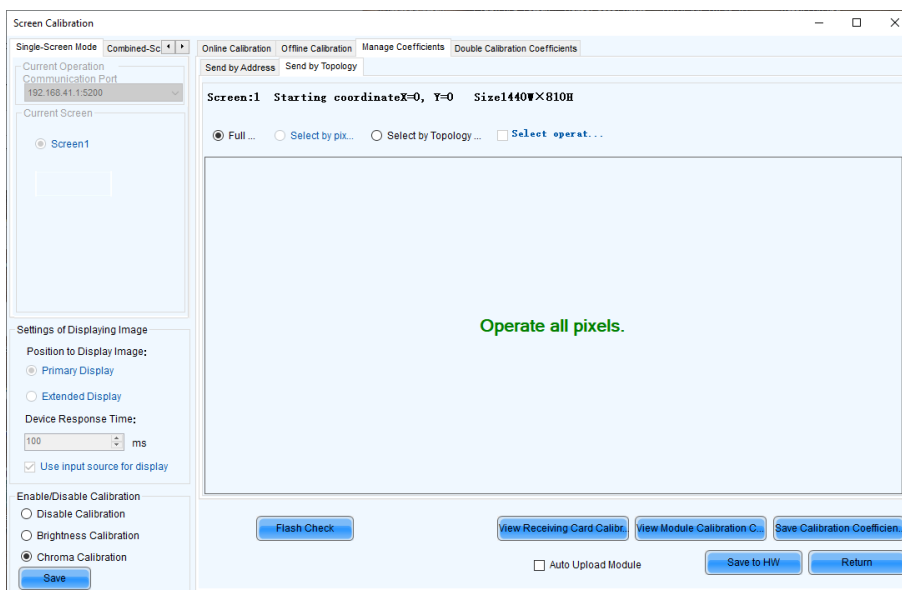
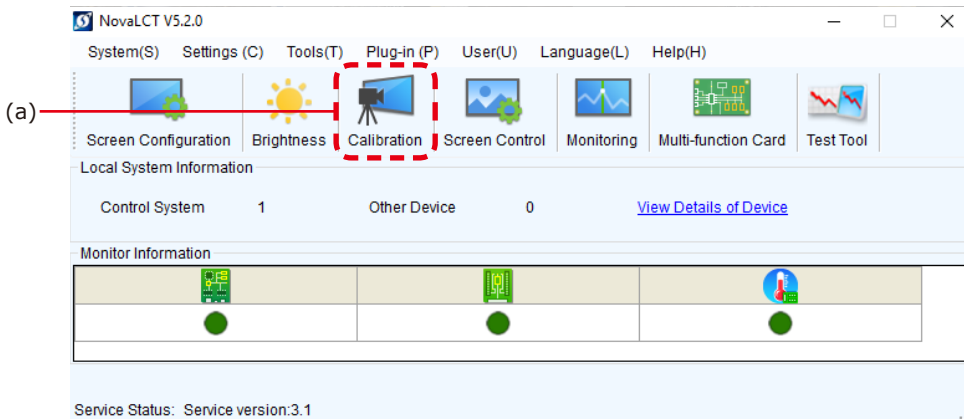

- (3) Check that "Chroma Calibration" (b) is selected and click the "Manage Coefficients" tab (c).

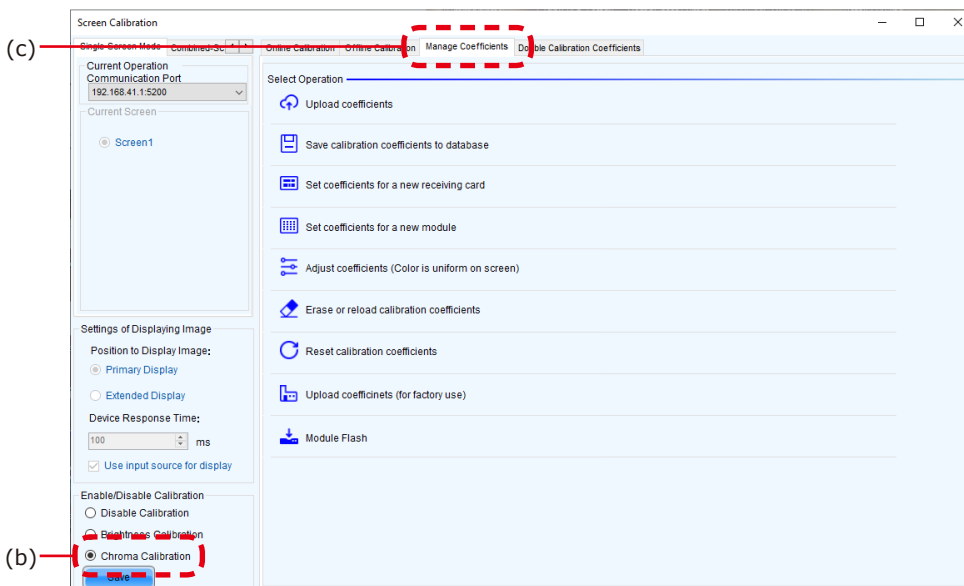

(4) Set "Extended Display" (d) under "Setting of Displaying Image", and then click "Adjust coefficients" (e).

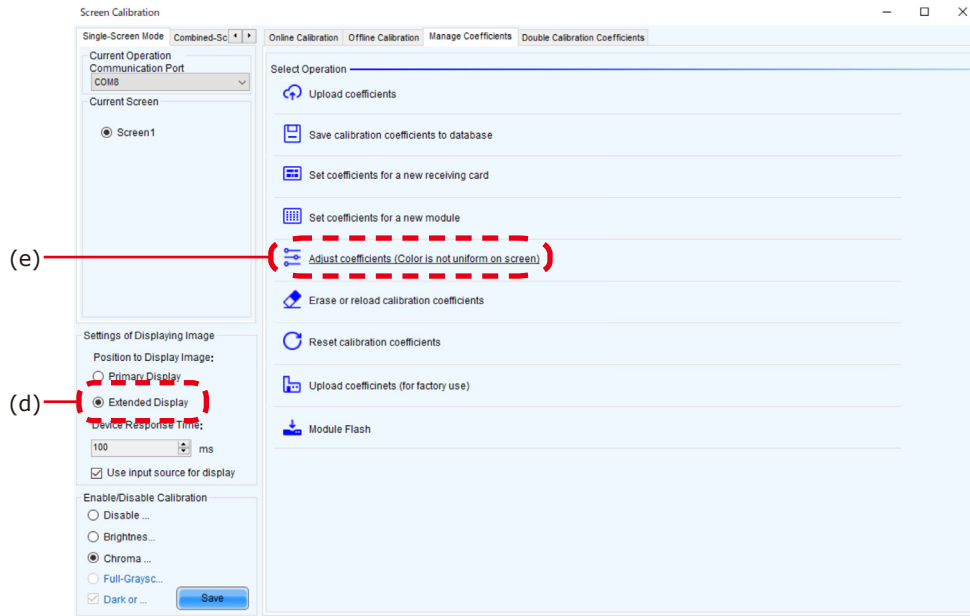

(5) Select the range specification method from the three available methods depending on the calibration range. After setting the range, click "Next" to display the "Adjust Coefficients" screen.

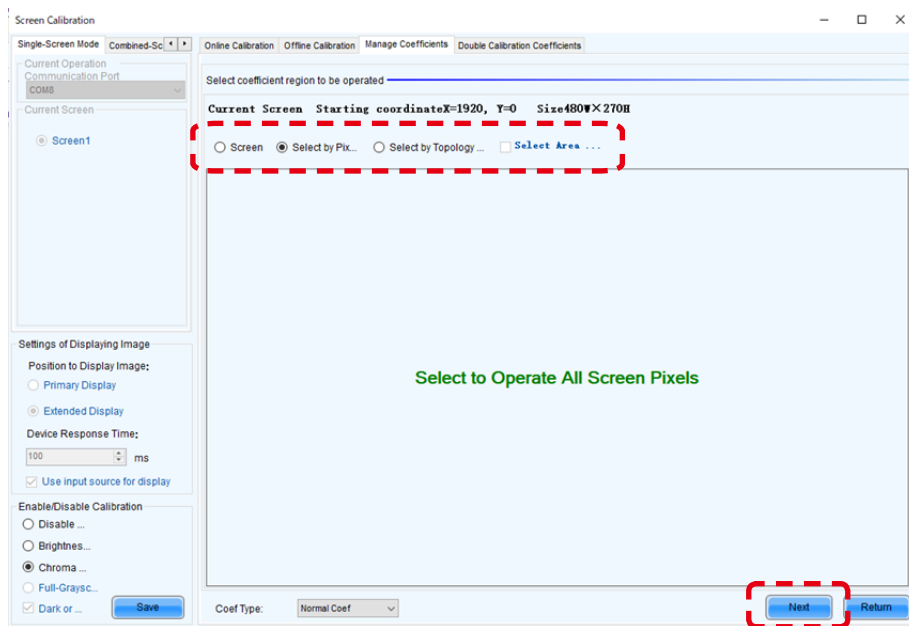

(5)-1

Screen: Adjust the entire frame set.

The calibration settings reading starts after "Next" is clicked. A fair amount of time is required to read the data.

The "Adjust Coefficients" screen is displayed when the data has been read.

(5)-2

Select by Pixel Area: Adjust by pixels.

Column Number...	480
Row Number of ...	540
Width	120
Height	135

The screen used to specify the adjustment range is displayed.

Column Number: The position (pixel) on the horizontal axis of the starting point (top left) of the selection range

Row Number: The position (pixel) on the vertical axis of the starting point (top left) of the selection range

Width: The horizontal distance from the points specified with "Column Number" and "Row Number"

Height: The vertical distance from the points specified with "Column Number" and "Row Number"

For reference: When specifying one pixel card

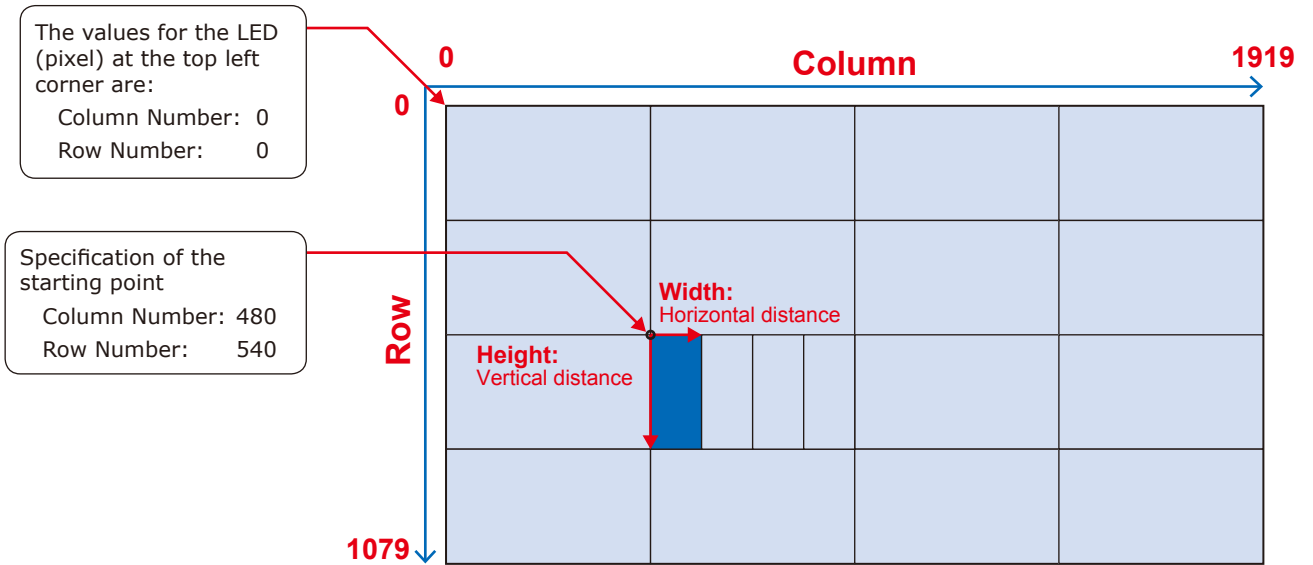

Product name	LED-E012i	LED-E015i	LED-E018i	LED-E025i
Pixel pitch	1.25 mm	1.56 mm	1.88 mm	2.50 mm
Number of displayed pixels (resolution/module)	Width 480 Height 270	Width 384 Height 216	Width 320 Height 180	Width 240 Height 135
Number of displayed pixels (resolution/pixel card)	Width 120 Height 270	Width 96 Height 216	Width 80 Height 180	Width 60 Height 135

Check that "Adjust Its Own Effect" is selected and click "Next" to start the calibration settings reading process.

The "Adjust Coefficients" screen is displayed when the data has been read.

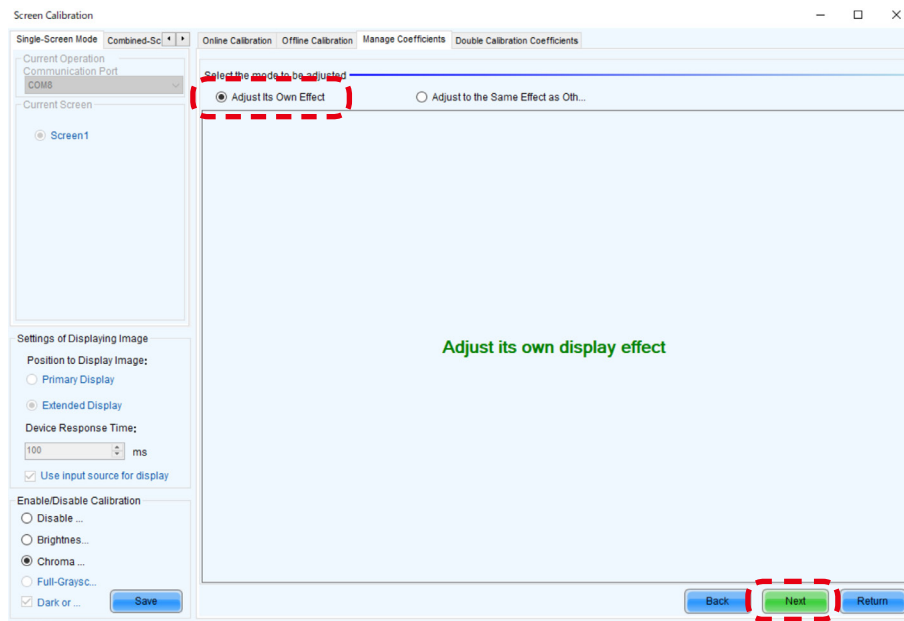

(5)-3

Select by Topology or List: Adjust multiple modules

A screen with the display configuration is displayed. Specify the range of the modules you want to adjust.



The calibration settings reading starts after "Next" is clicked.

The "Adjust Coefficients" screen is displayed when the data has been read.

- (6) Adjust Coefficients screen
Click "Advanced Adjustment".

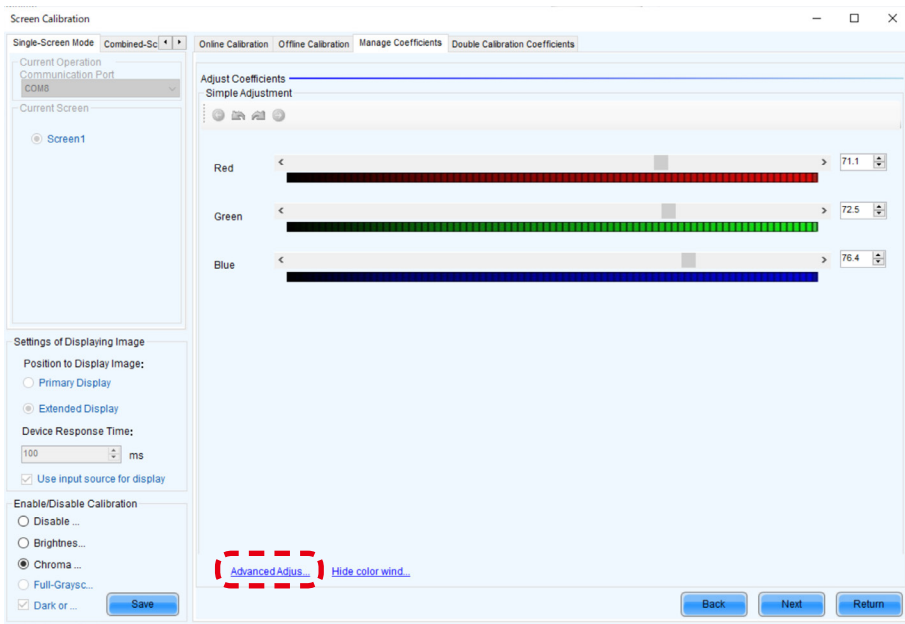

- (7) Adjust the "Color adjustment of red, green and blue" parameters, and then adjust the "Color matching of red, green and blue" parameters.

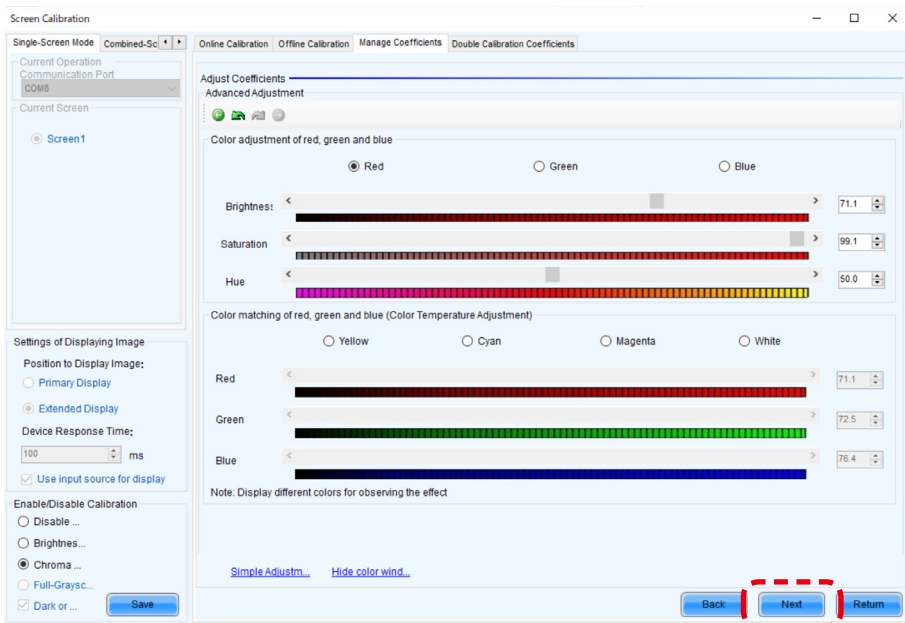

Click "Next" after you have finished the adjustment.

- (8) Click "Save" to save the calibration settings you have adjusted.
- (9) Click "Finish" to complete the procedure.

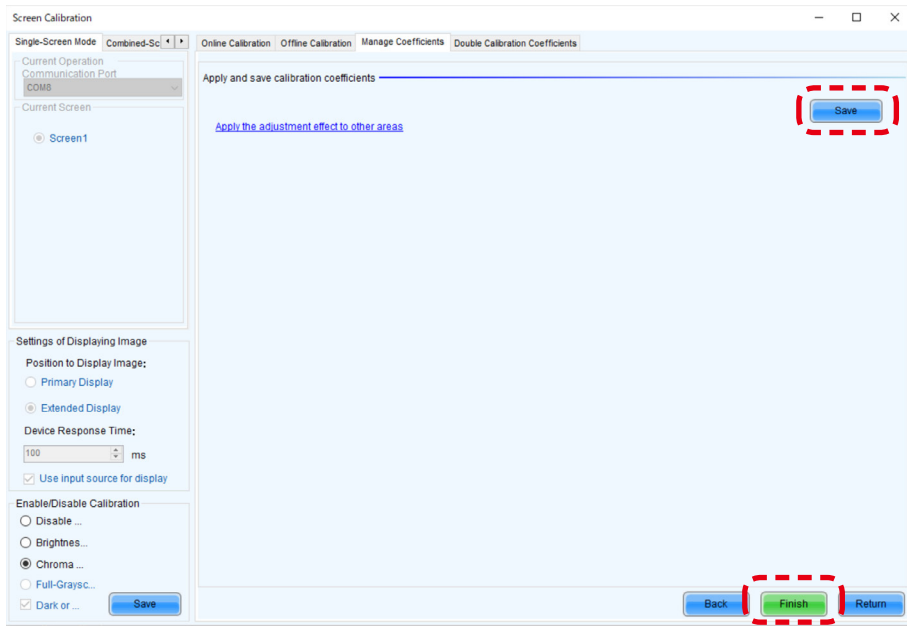

Note

To return the calibration adjustment values to their default setting, perform the "Update the Calibration Data" procedure ([English-44](#)).

3. State monitoring using the software

In case of a problem, you will be able to determine the location where it occurred by monitoring the state of the system.

3-1 Display under normal conditions

The display is green under normal conditions.

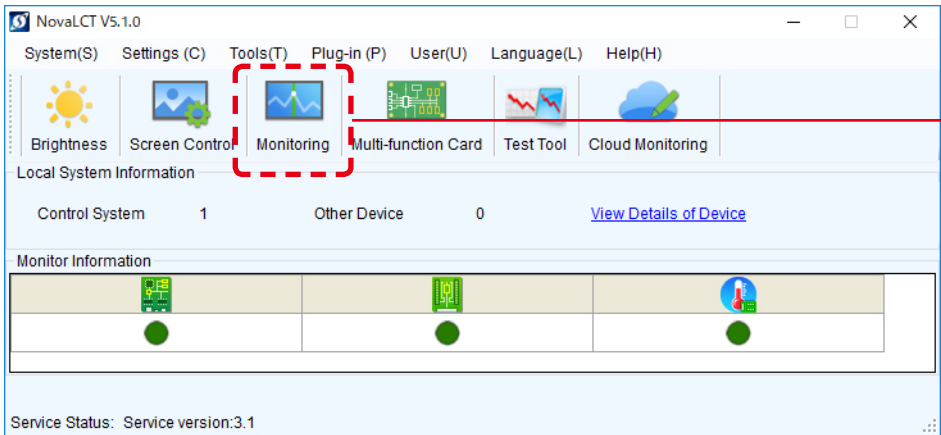

Click "Monitoring" to check

- the state of the LED controller
- the operating state of the LED modules
- the temperature of the LED modules

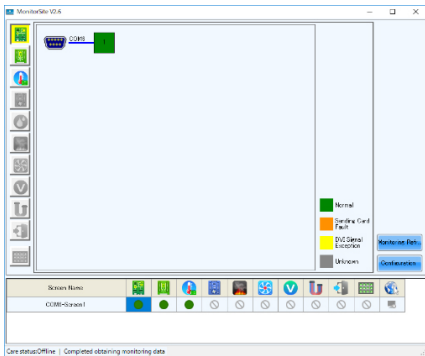

State of the LED controller

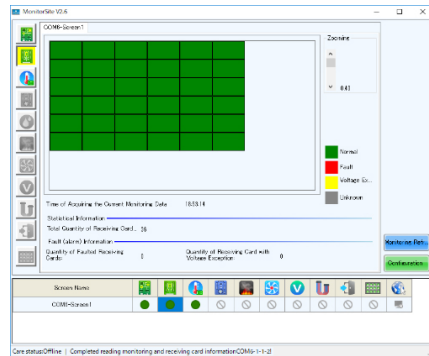

State of the LED modules

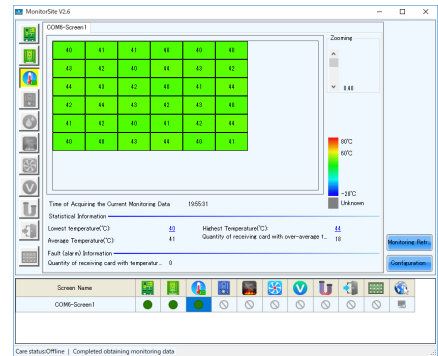

Temperature of the LED modules

3-2 Display under abnormal conditions

(1) Problem with the input signal to the LED controller

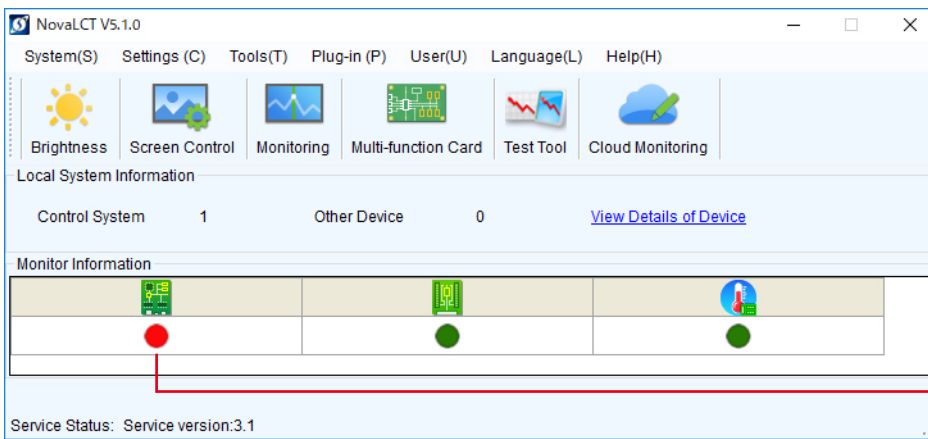

When the display is red, there is a problem with the LED controller.

To display more details, click "Monitoring", and then click "Sending card" on the screen that is displayed.

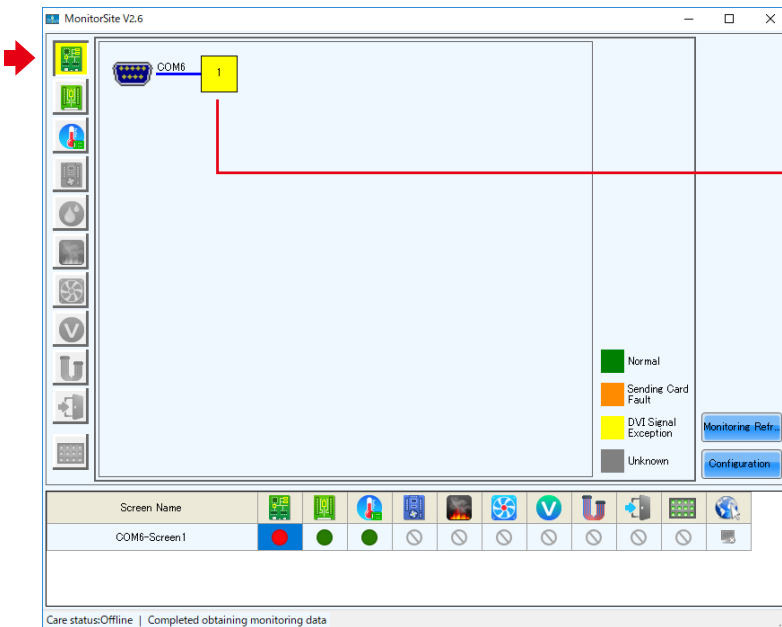

No video signal is being input to the LED controller.

- Check that the LAN cable is connected.
- Check that a video signal is being output from the video output equipment.
- If multiple signals are being input to the LED controller, check the input settings of the LED controller.

(2) Problem with the LED modules

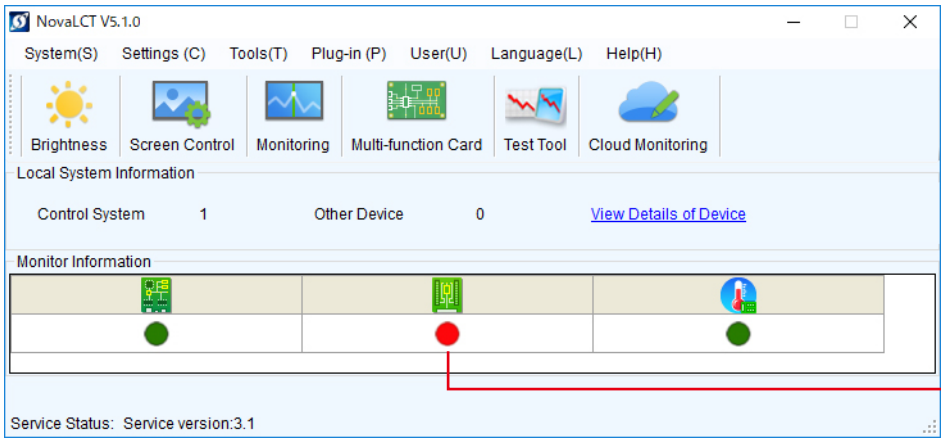

When the display is red, there is a problem with the LED module operation.

To display more details, click "Monitoring", and then click "Receiving card" on the screen that is displayed.

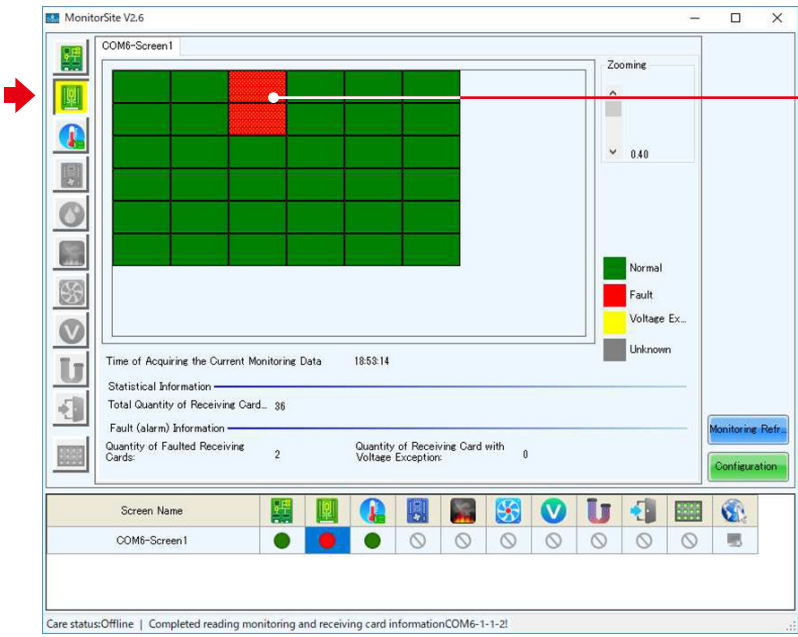

In the example shown on the left, the following problems must be considered.

- Signal loss between the screen of the 1st row 3rd column and the screen of the 1st row 2nd column
→ Check the LAN cable.
- Problem with the power unit of the screen of the 1st row 2nd column
→ Check the LAN cable.
- Problem with the receiving card of the screen of the 1st row 2nd column.
→ Check that the receiving card is securely connected.

With the connection shown in the figure below.

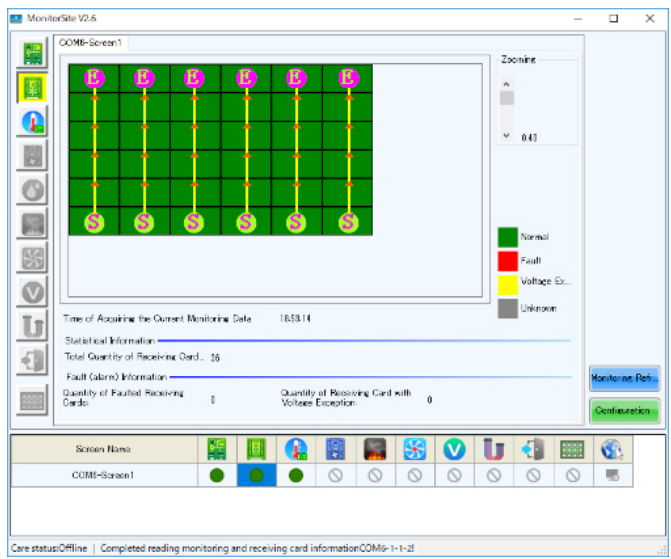

(3) Problem with the internal temperature of the LED modules

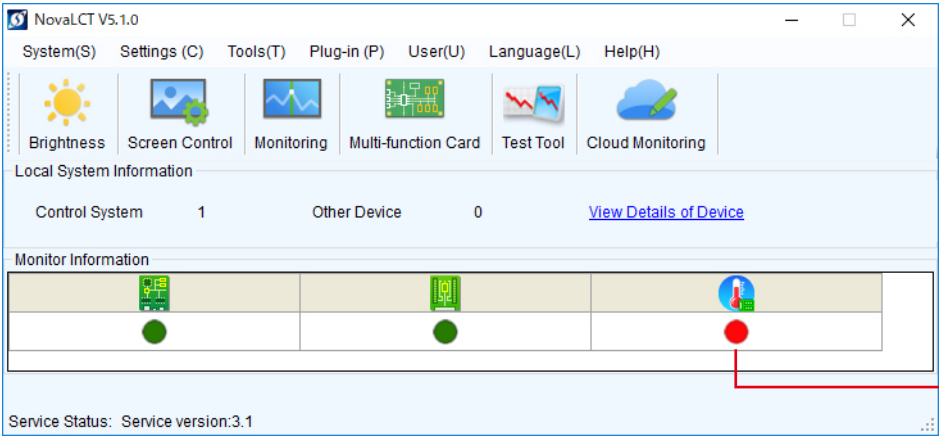

There is a problem with the LED module operation.

To display more details, click "Monitoring", and then click "Temperature" on the screen that is displayed.

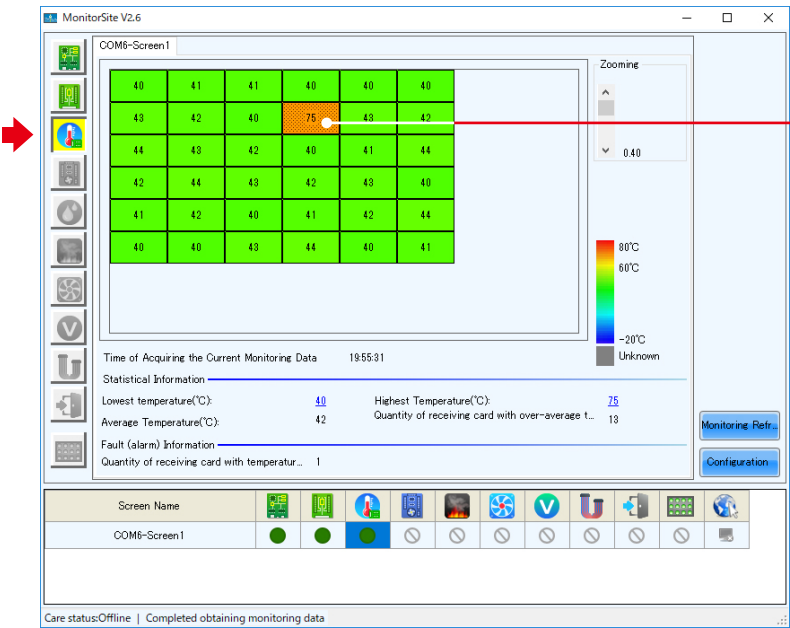

The LED modules with a high temperature are displayed in warm colors.
 Since the internal temperature is high, decrease the brightness setting.
 If changing the brightness setting could not solve the problem, contact your retailer or the Customer Service.

(4) Communication problem

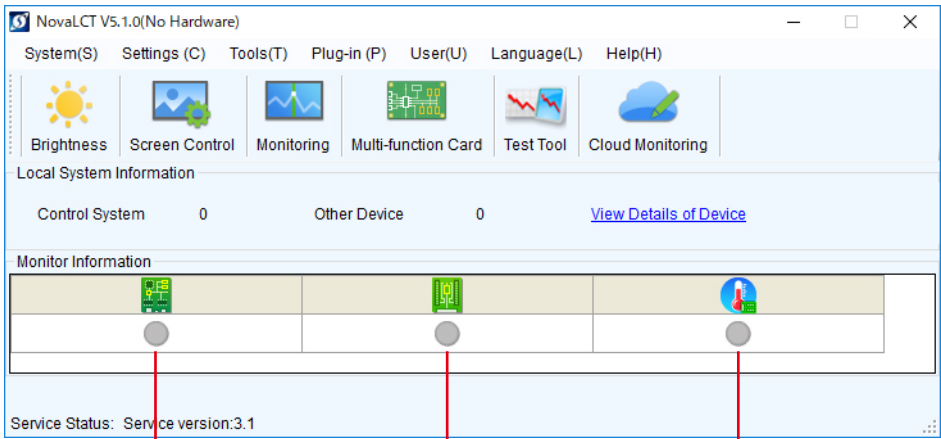

When the display is grey, the communication is not established.
→ Check that the USB cable is connected.
→ Check that the LED controller is turned on.

4. Redundancy setting method

4.1 Configuring the settings with two LED controllers connected to the PC using LAN cables

Connect the LED controllers and the LED modules with LAN cables.

Terminate the Backup system connection at the RJ-45 connector located top left on the last module in the daisy chain connection.

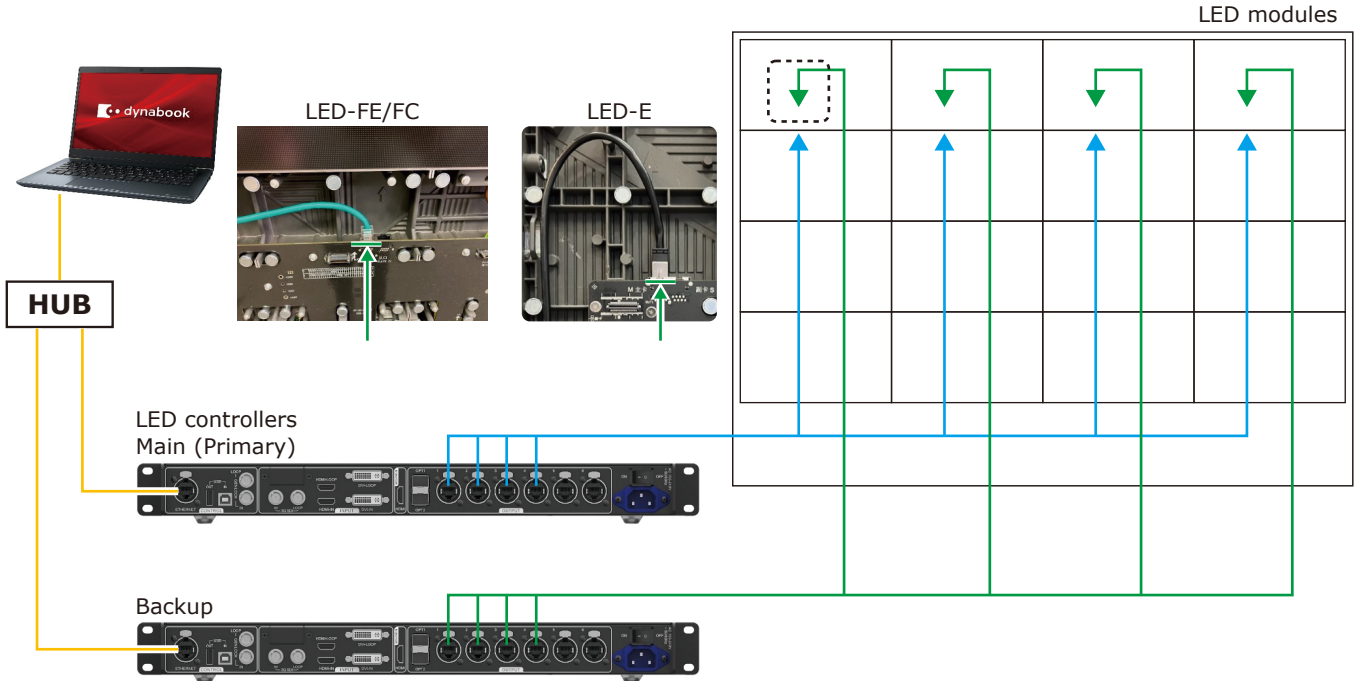

* For the MCTRL 4K LED controller, the way to make connections is similar to this example.

Start the control software NovaLCT and log in with the administrator privileges.

Display the login screen as follows: User(U) -> Advanced Synchronous System UserLogin(A). Enter the password ("admin") to log in with the administrator privileges.

Click "Screen Configuration".

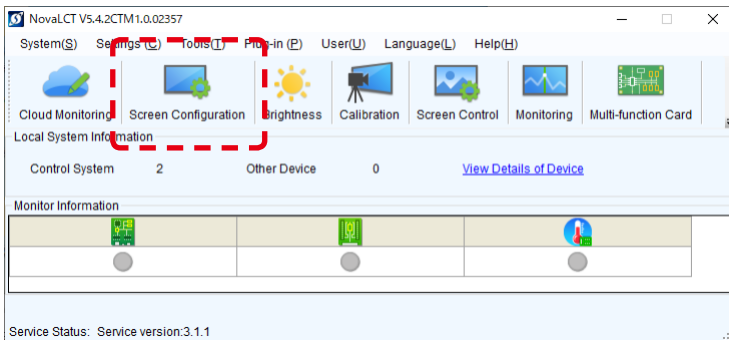

Communication Port	Device Type	Number of Devices	SN
172.1.0.10:5200	MCTRL4K	1	002CF7010000...
172.1.0.11:5200	MCTRL4K	1	002CFD010000...

Check the port in "Select Communication Port", select the Main (Primary) and Backup system LED controllers by their IP address, and then click "Next".

Configure the settings for the Main (Primary) controller and Backup controller separately.

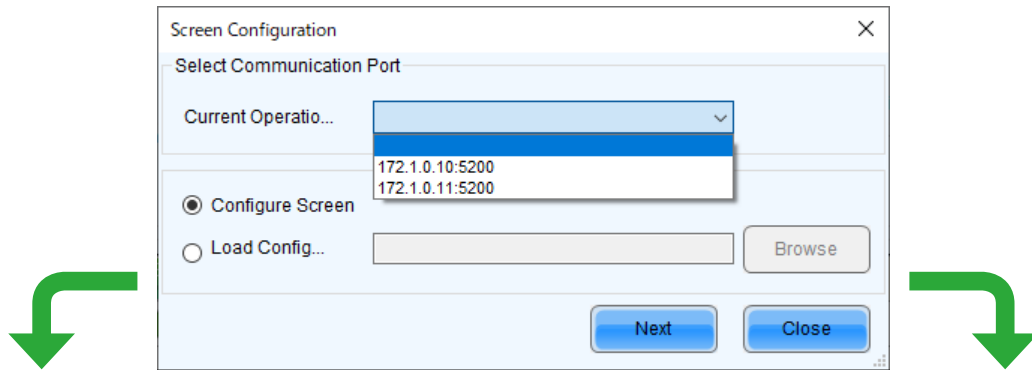

Main (Primary)

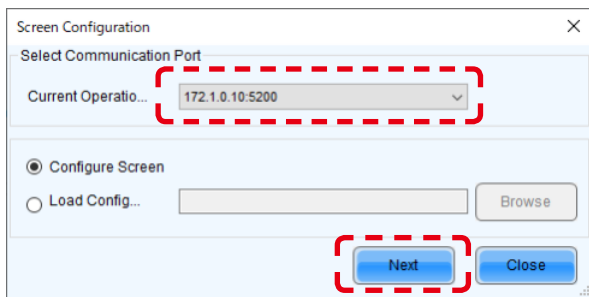

Backup

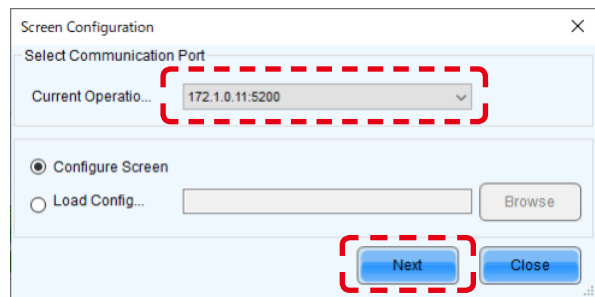

On the Main (Primary) side

Click the "Restore Factory Settings" button for initialization.

After initialization, configure the settings for "Select Input Source" and "Source Configuration".

If the factory setting is correctly configured and the device connection is the same as when the factory setting was configured, check the settings without performing initialization.

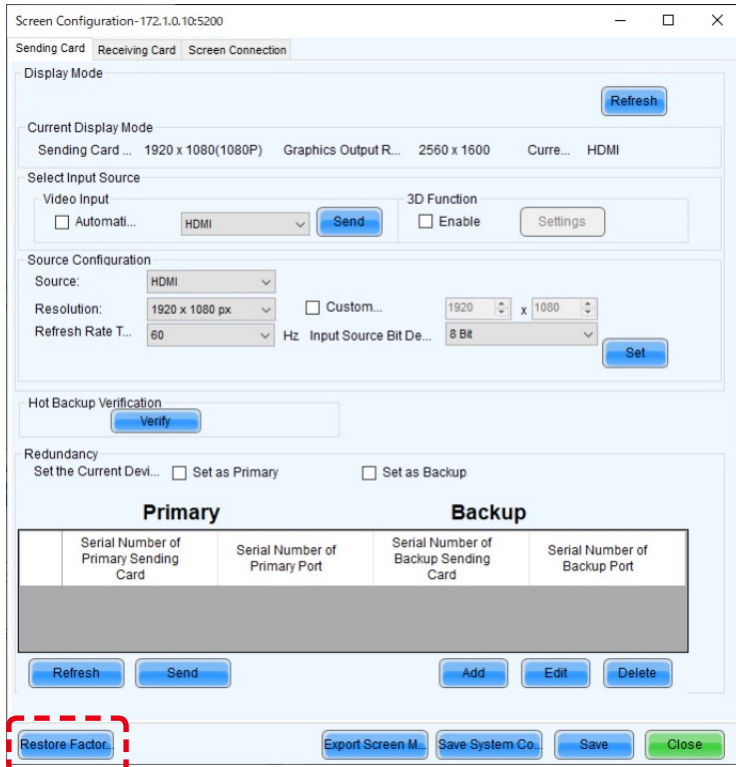

Main (Primary)

Select the Screen Connection tab.

Select/enter the value for "Screen Type", "Receiving Card Size", "Columns" and "Rows", and use "Ethernet Port No." and the screen configuration section to configure the connection.

* For details of the configuration procedure, refer to the User's Manual.

Next, select the Sending Card tab.

Go to "Redundancy", select the checkbox for "Set as Primary" and click "Save".

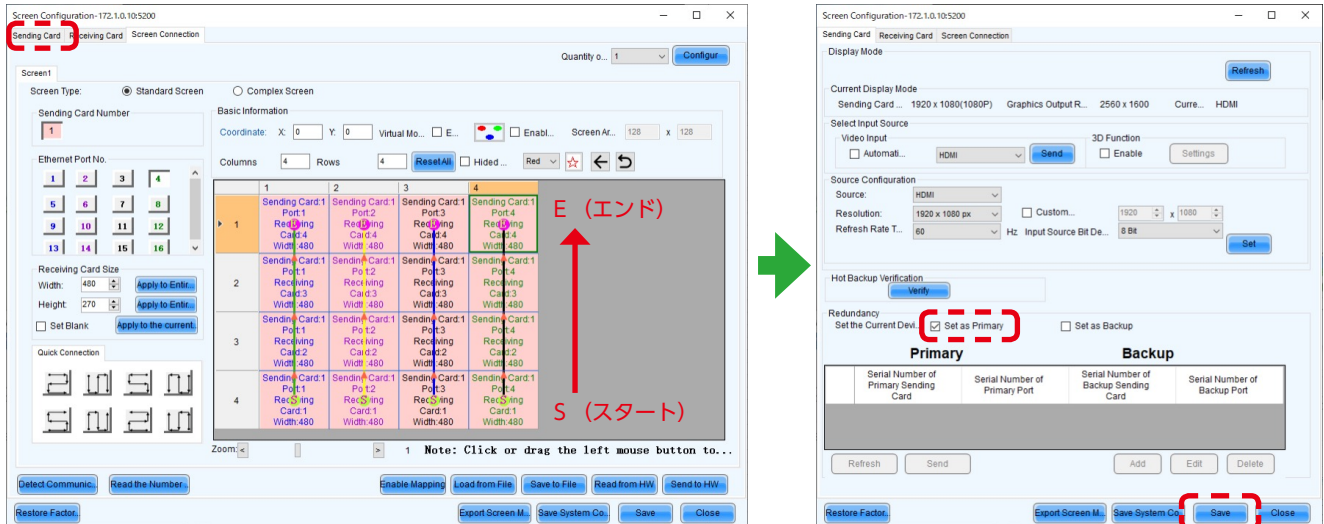

On the Backup side

Click the "Restore Factory Settings" button for initialization.

After initialization, configure the settings for "Select Input Source" and "Source Configuration".

If the factory setting is correctly configured and the device connection is the same as when the factory setting was configured, check the settings without performing initialization.

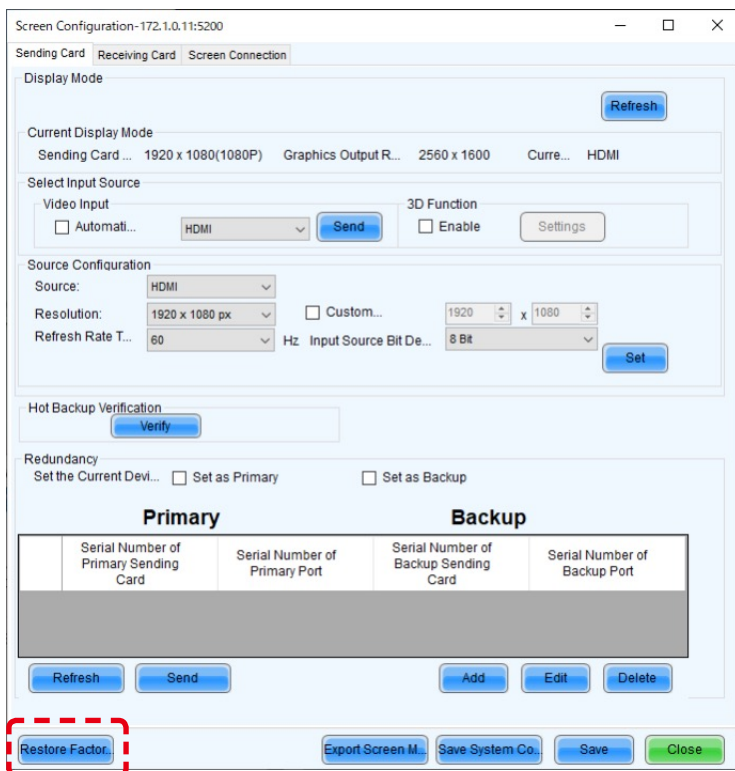

Backup

Select the Screen Connection tab.

Configure the connection in the same way as for Main (Primary).

* The direction of connection is the same as for Main (Primary).

Next, select the Sending Card tab.

Go to "Redundancy", select the checkbox for "Set as Backup" and click "Save".

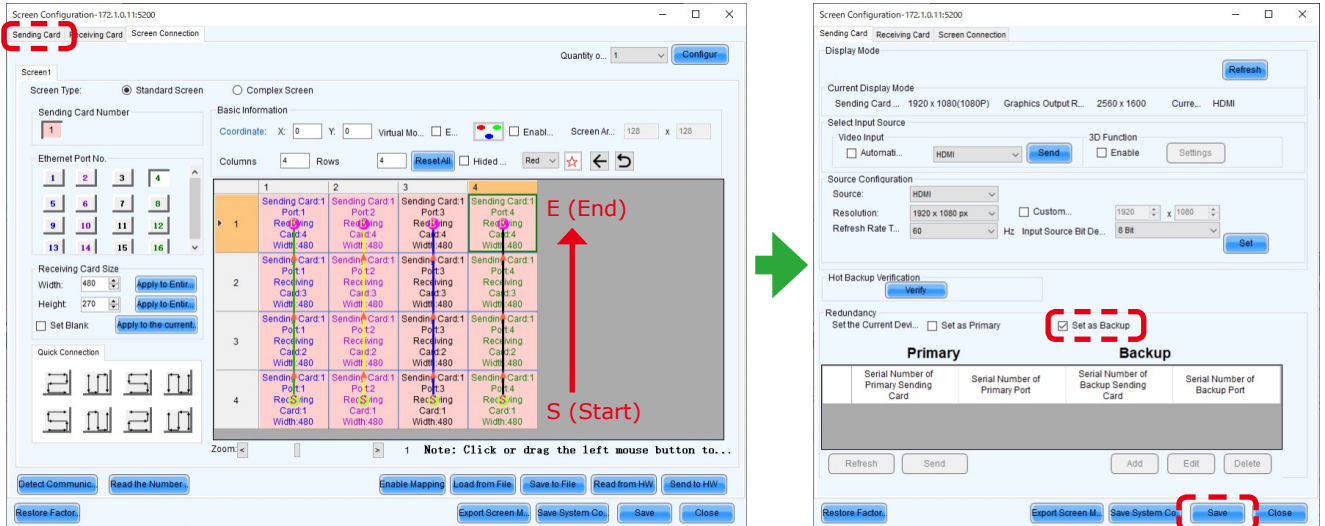

Check the current brightness setting.

Click the "Brightness" button.

In the Brightness Adjustment screen, set the desired brightness value and click the "Save to HW" button.

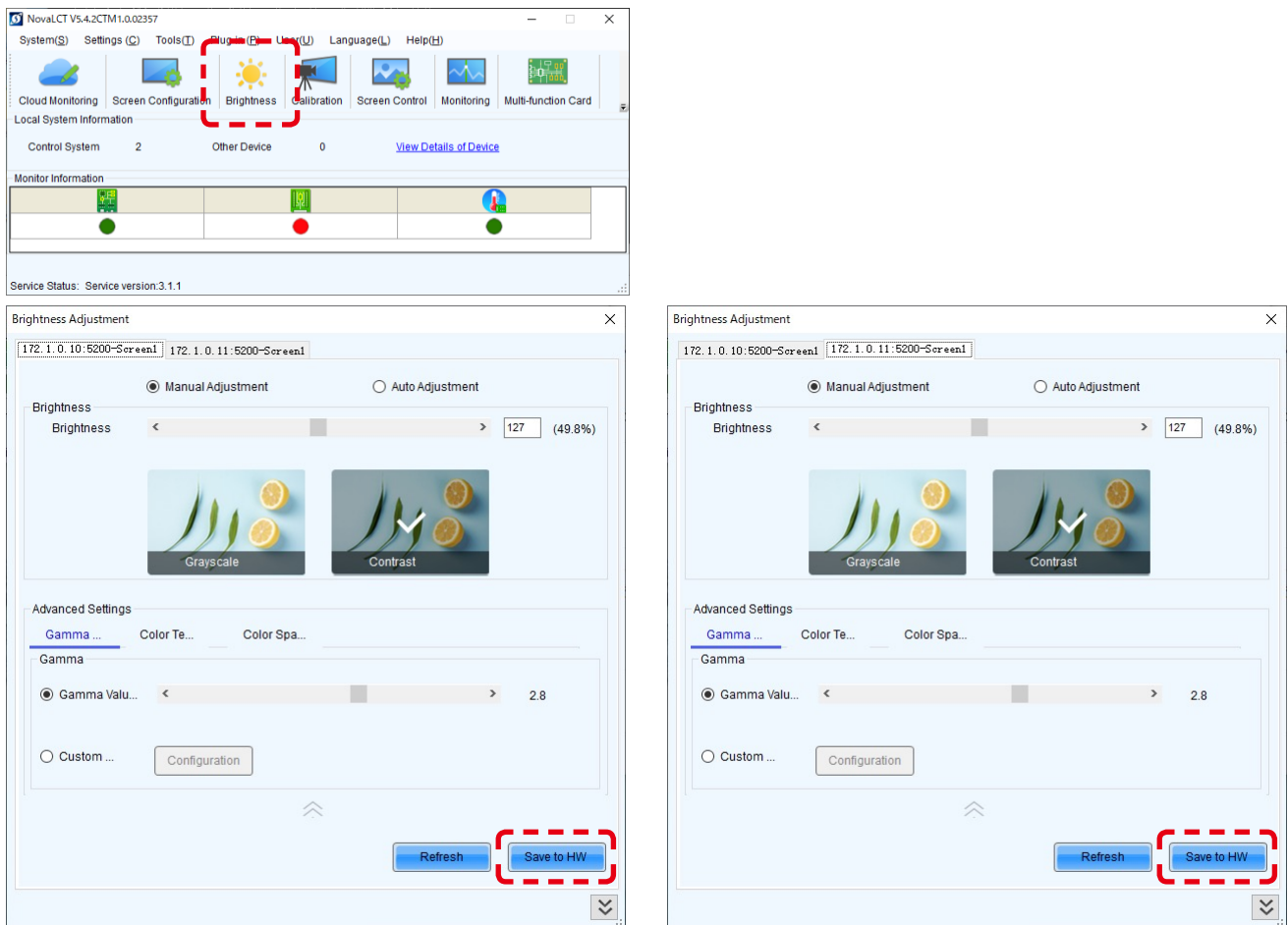

The monitoring screens appear like below.

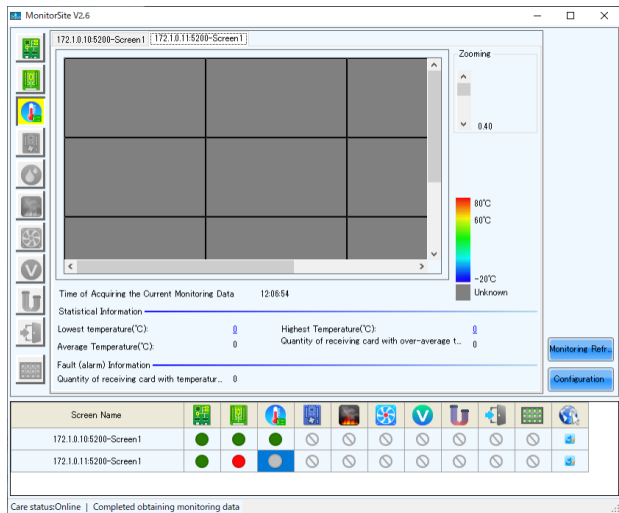
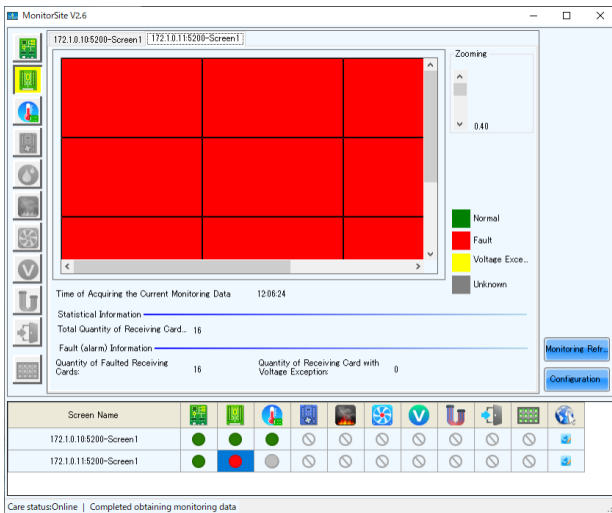
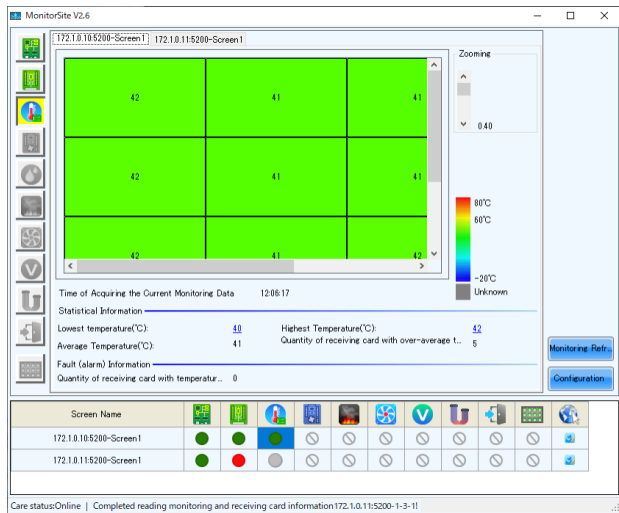
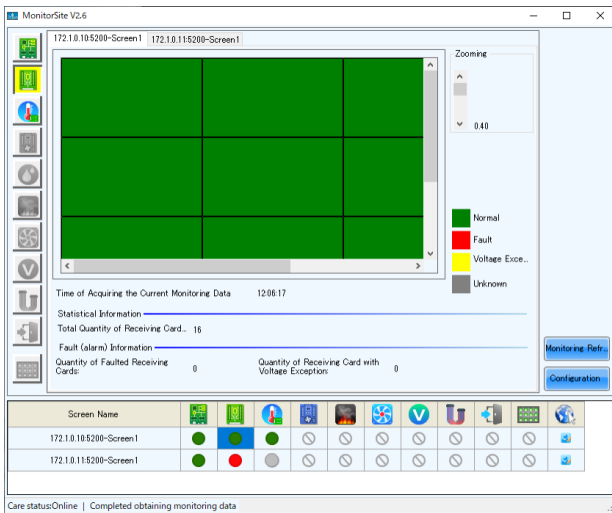
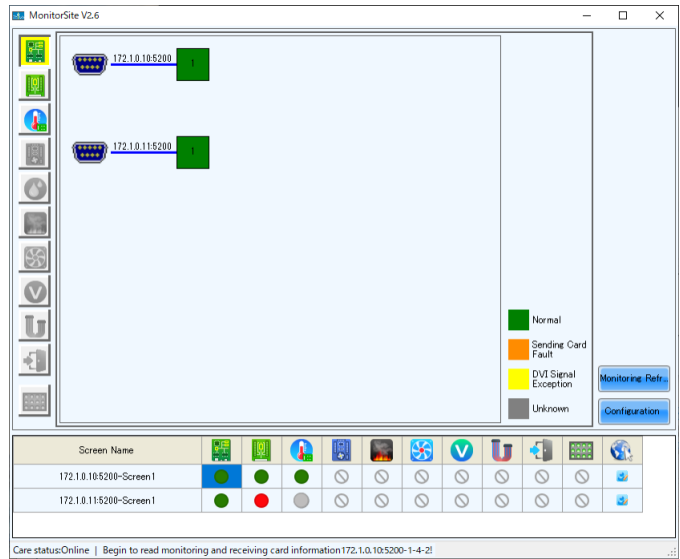
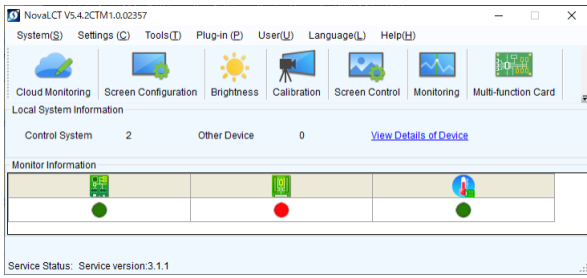

Note: On the monitoring screen, the LED modules configured as “Backup” are displayed in red color (this is not an indication of a fault).

If a fault occurs on modules configured as “Main (Primary)”, “Backup” modules are displayed in green color, which is an indication of normal state.

“Main (Primary)” modules are operating normally

Main (Primary)

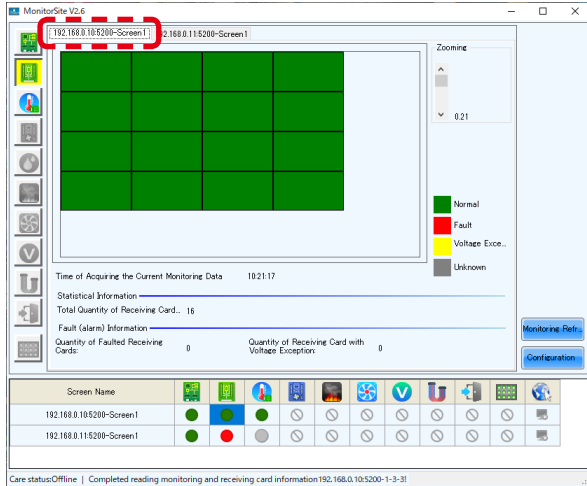

Backup

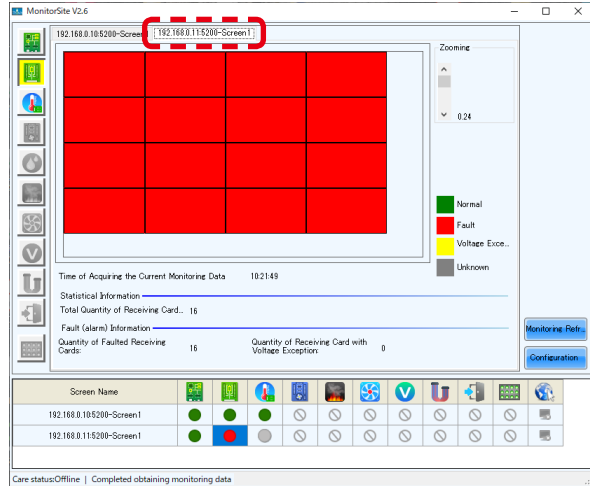

Modules connected to port 1 are operating as “Backup”.

Main (Primary)

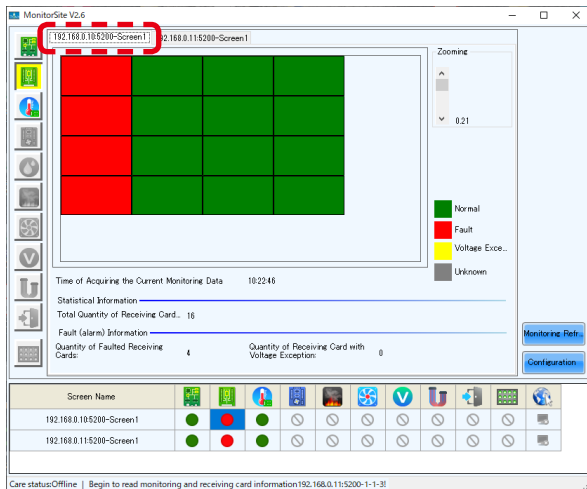

Backup

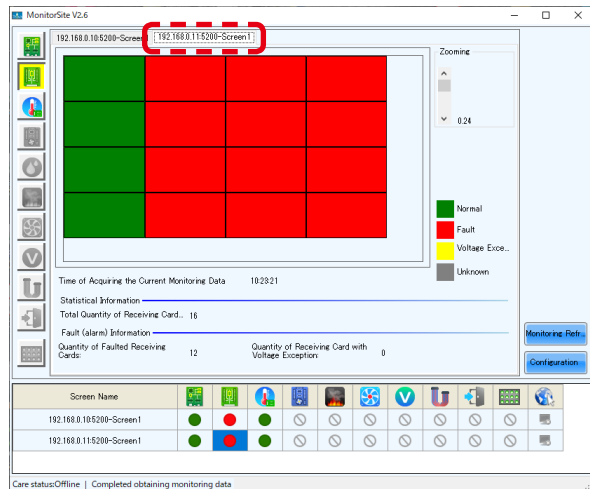

In the start-up screen of NovaLCT, the status indicator circle for “Monitor Information” receiving card becomes red in color.

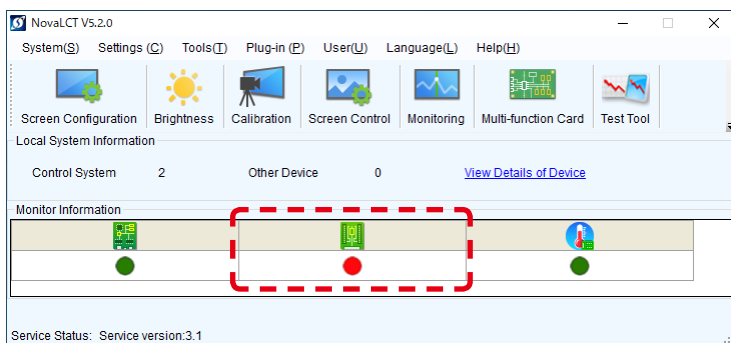

In the case of MCTRL 4K, the display of the LED controllers is as follows.
(This example display is for the case of connection using four Ethernet cables.)
Upper: Backup
Lower: Main (Primary)



4.2 Configuring the settings with two LED controllers connected to the PC using USB cables

Connect the LED controllers and the LED modules with LAN cables.

Terminate the Backup system connection at the RJ-45 connector located top left on the last module in the daisy chain connection.

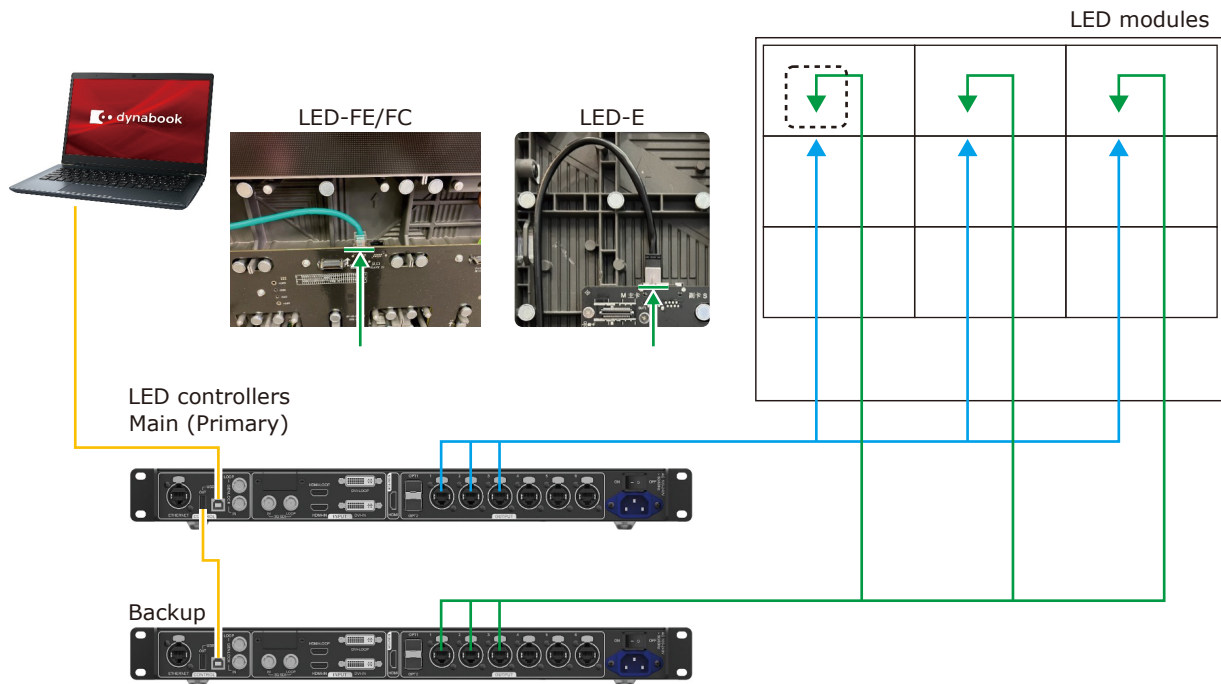

* For the MCTRL 4K LED controller, the way to make connections is similar to this example.

Start the control software NovaLCT and log in with the administrator privileges.

Display the login screen as follows: User(U) -> Advanced Synchronous System UserLogin(A). Enter the password ("admin") to log in with the administrator privileges.

Click "Screen Configuration".

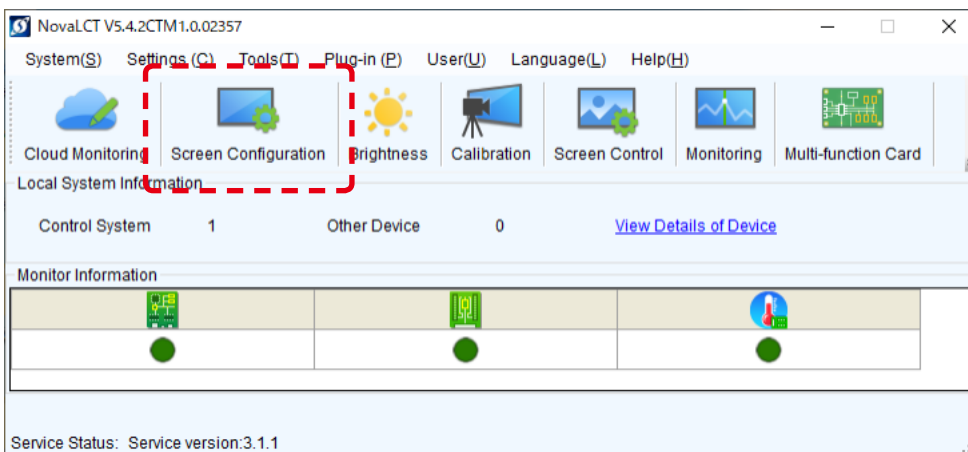

Select the port in "Select Communication Port", and then click "Next".

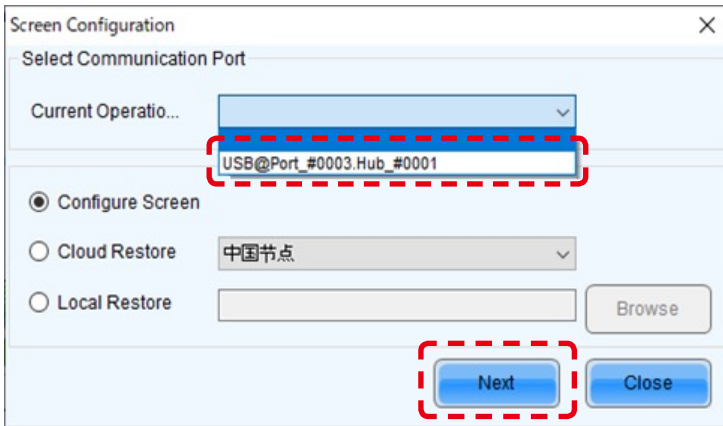

In the Screen Configuration screen that is displayed, select the "Sending Card" tab.

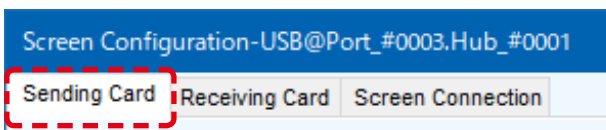

Click the "Restore Factory Settings" button for initialization.

After initialization, configure the settings for "Select Input Source" and "Source Configuration".

If the factory setting is correctly configured and the device connection is the same as when the factory setting was configured, check the settings without performing initialization.

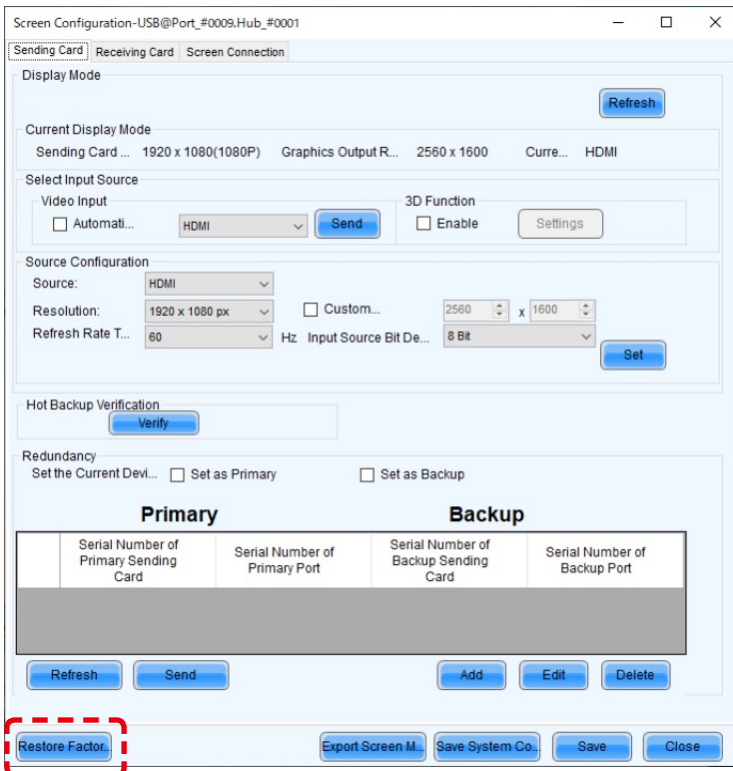

Select the Screen Connection tab.

Select/enter the value for "Screen Type", "Receiving Card Size", "Columns" and "Rows", and use "Ethernet Port No." and the screen configuration section to configure the connection.

* For details of the configuration procedure, refer to the User's Manual.

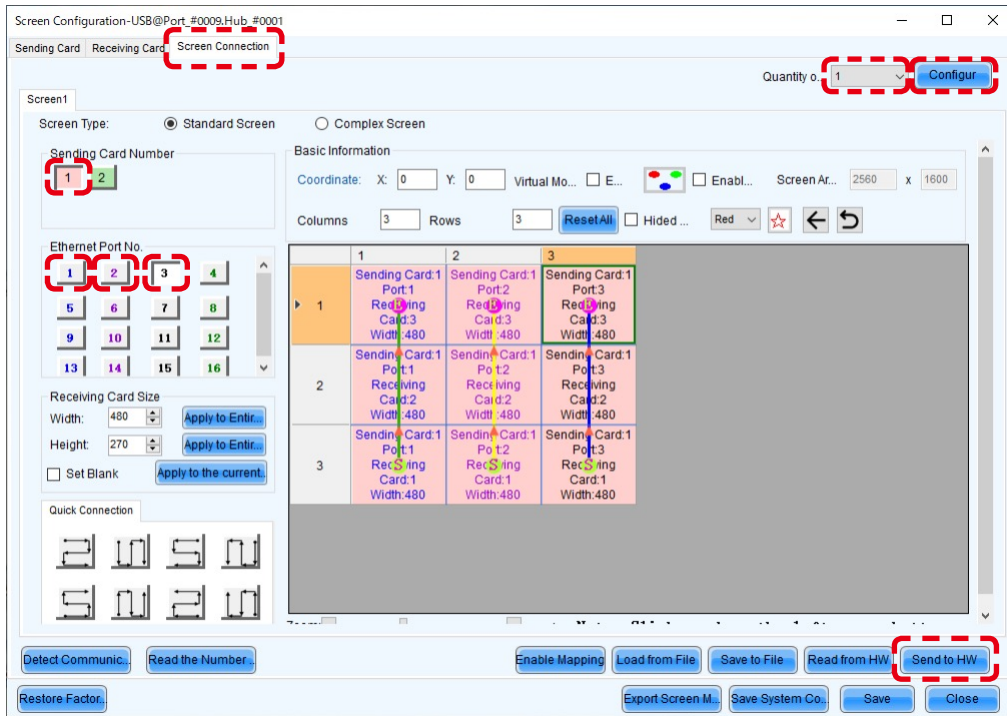

Notes on the setting operation:

Perform these setting procedures prior to the redundancy settings configuration.

Make sure that the value of "Quantity of Screens" is 1.

(To change a different value to 1, click the "Configure" button.)

It is not necessary to configure the settings for Sending Card 2.

When the settings configuration is complete, click the "Send to HW" button.

Select the Sending Card tab and click "Add".

The Redundancy Settings screen is displayed.

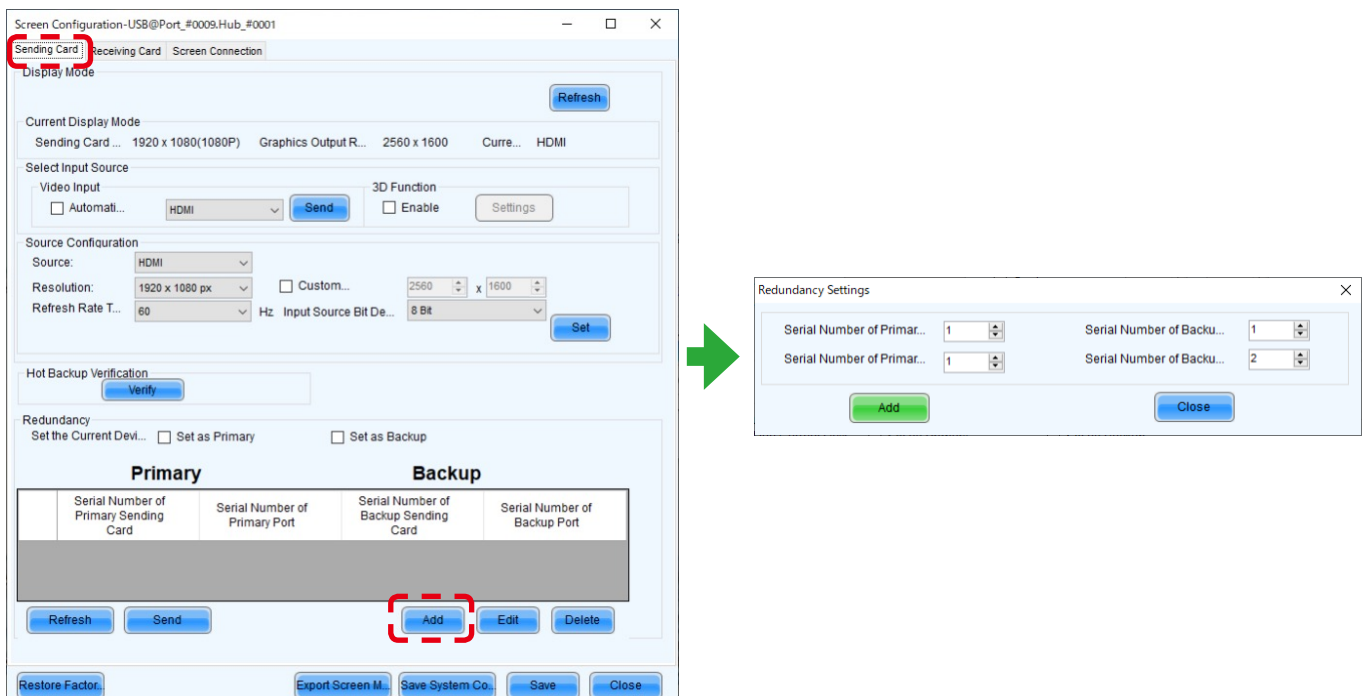

In the Redundancy Settings screen, set the Port number of the Backup side LED controller (Sending Card) that matches the Port number of the Primary side LED controller (Sending Card).
After entering the value, click the "Add" button.

In the LED configuration example ([English-71](#)), the settings are as follows.

Serial Number of Primary Sending Card : 1
Serial Number of Primary Port : 1
Serial Number of Backup Sending Card : 2
Serial Number of Backup Port : 1
Serial Number of Primary Sending Card : 1
Serial Number of Primary Port : 2
Serial Number of Backup Sending Card : 2
Serial Number of Backup Port : 2
Serial Number of Primary Sending Card : 1
Serial Number of Primary Port : 3
Serial Number of Backup Sending Card : 2
Serial Number of Backup Port : 3

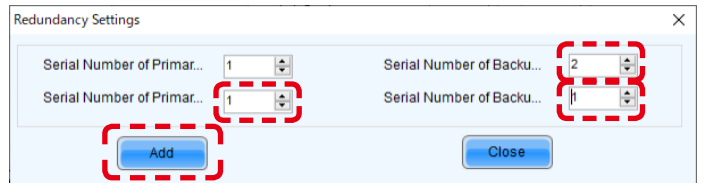

When the settings configuration is complete, the Sending Card tab appears like below.
Click the "Send" button.
Click the "Save" button.

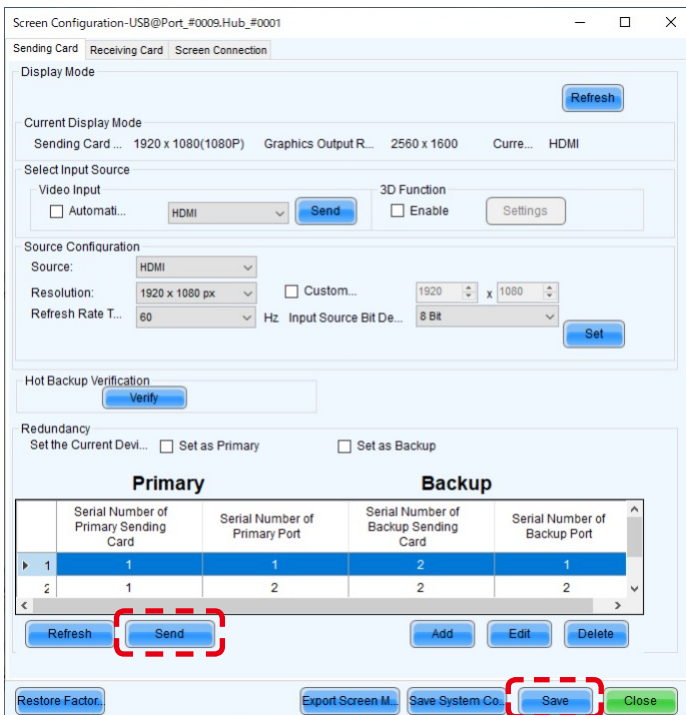

Check the current brightness setting.

Click the "Brightness" button.

In the Brightness Adjustment screen, set the desired brightness value and click the "Save to HW" button.

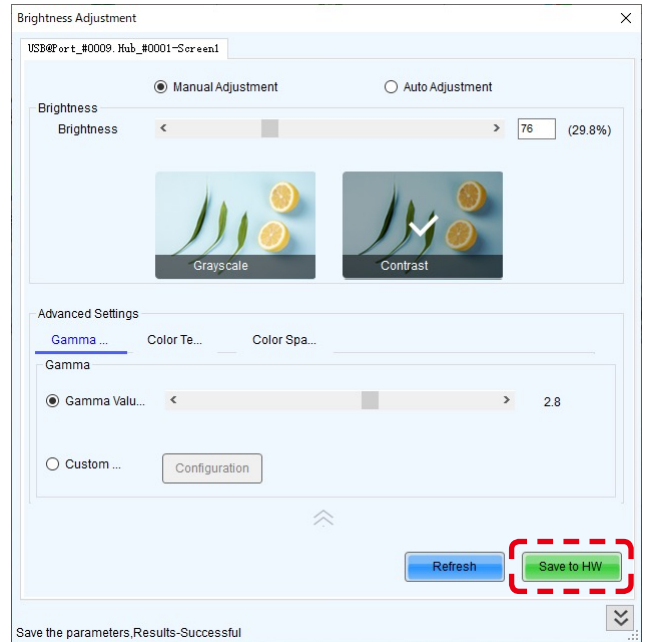
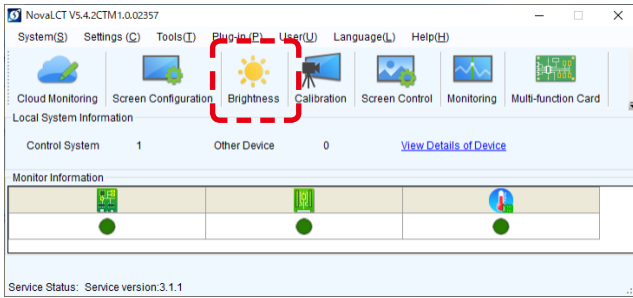

The monitoring screens appear like below.

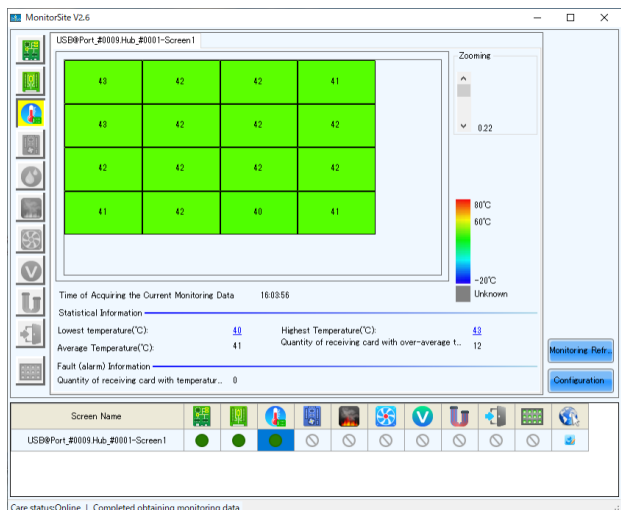
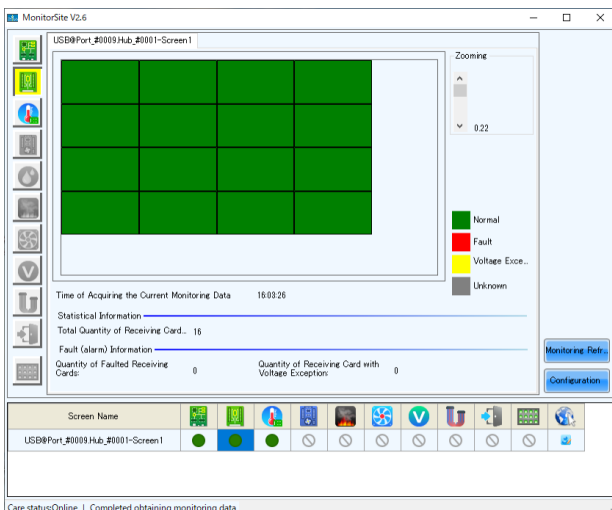
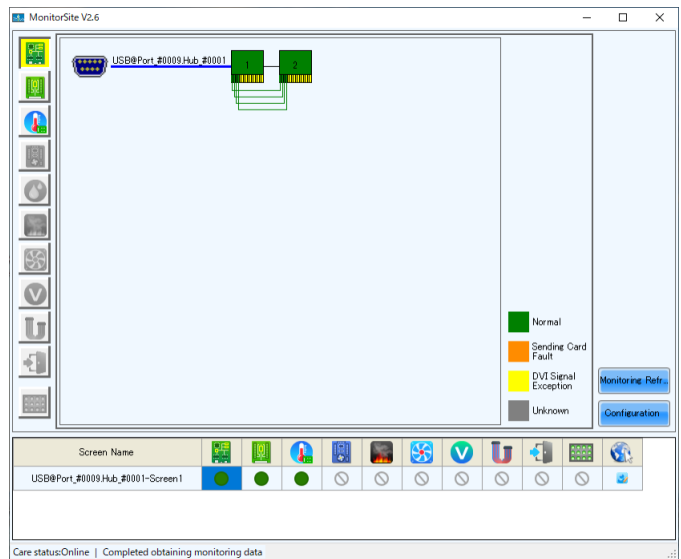
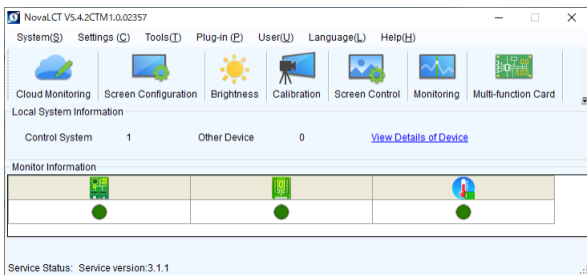

In the case of MCTRL 4K, the display of the LED controllers is as follows.
(This example display is for the case of connection using four Ethernet cables.)

Upper: Backup

Lower: Main (Primary)



4.3 Configuring the settings with one LED controller connected to the PC using a USB cable

Connect the LED controllers and the LED modules with LAN cables.

Terminate the Backup system connection at the RJ-45 connector located top left on the last module in the daisy chain connection.

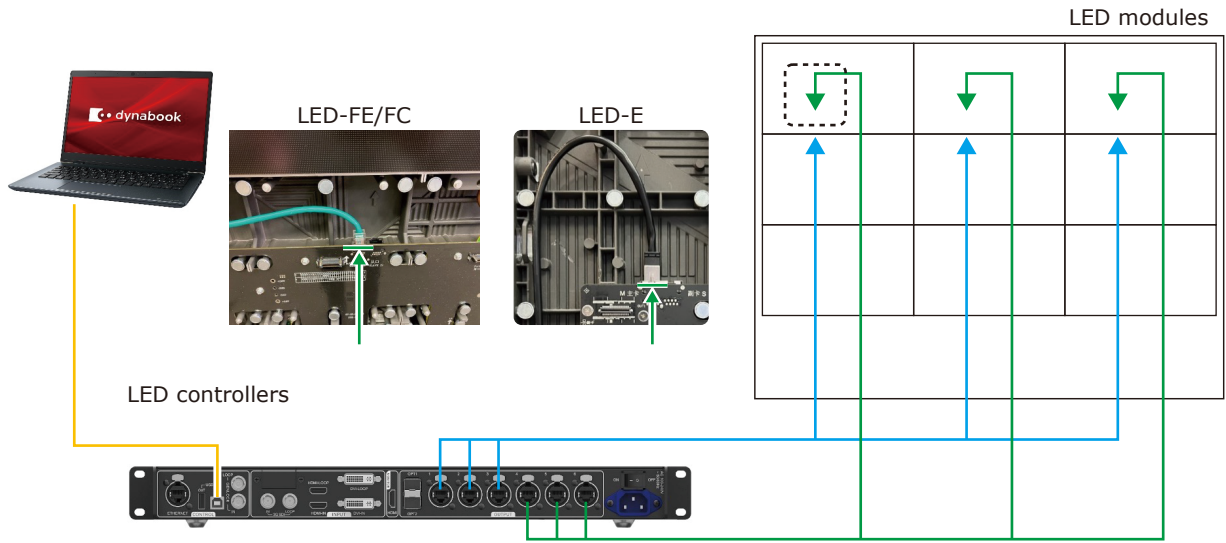

* For the MCTRL 4K LED controller, the way to make connections is similar to this example.

Start the control software NovaLCT and log in with the administrator privileges.

Display the login screen as follows: User(U) -> Advanced Synchronous System UserLogin(A). Enter the password ("admin") to log in with the administrator privileges.

Click "Screen Configuration".

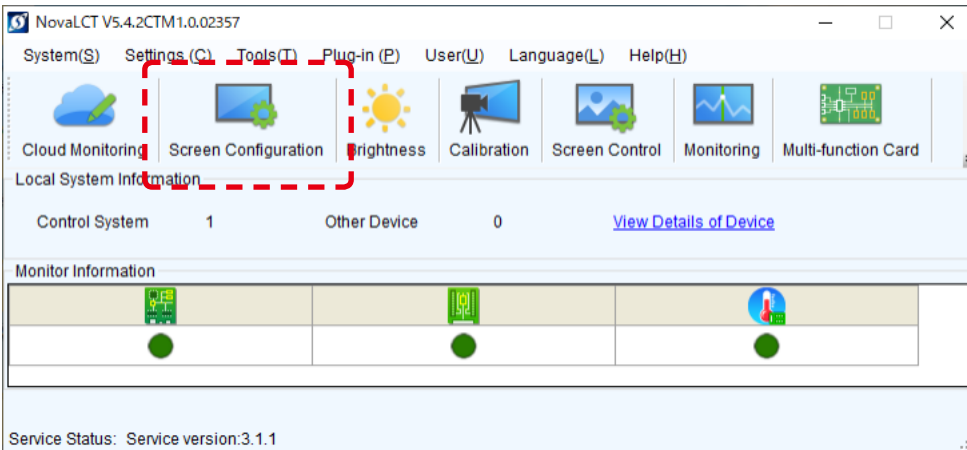

Select the port in "Select Communication Port", and then click "Next".

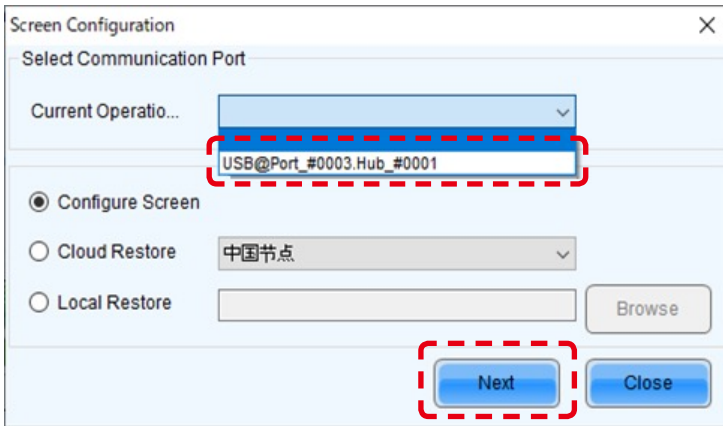

Click the "Restore Factory Settings" button for initialization.

After initialization, configure the settings for "Select Input Source" and "Source Configuration".

If the factory setting is correctly configured and the device connection is the same as when the factory setting was configured, check the settings without performing initialization.

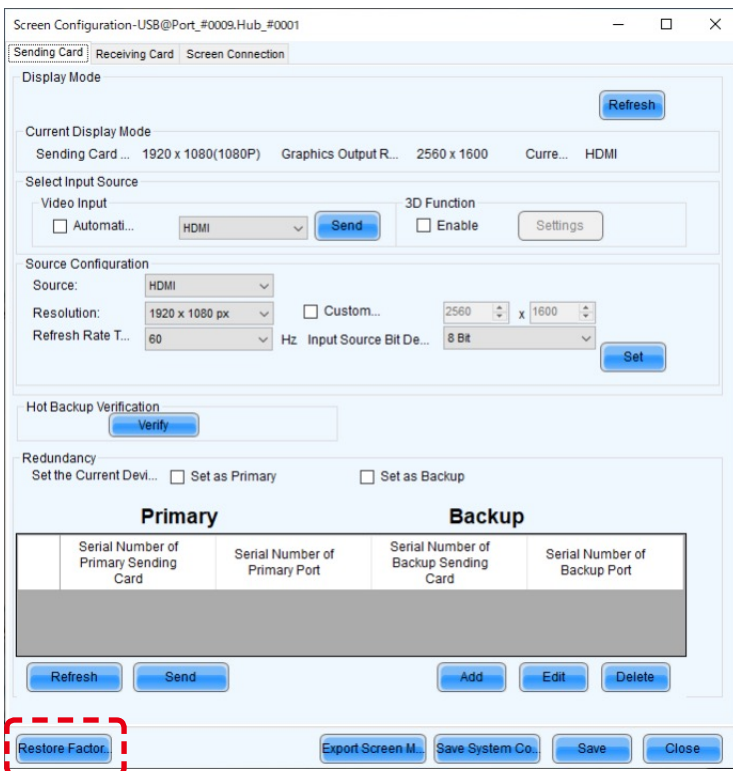

Select the Screen Connection tab.

Select/enter the value for "Screen Type", "Receiving Card Size", "Columns" and "Rows", and use "Ethernet Port No." and the screen configuration section to configure the connection.

* For details of the configuration procedure, refer to the User's Manual.

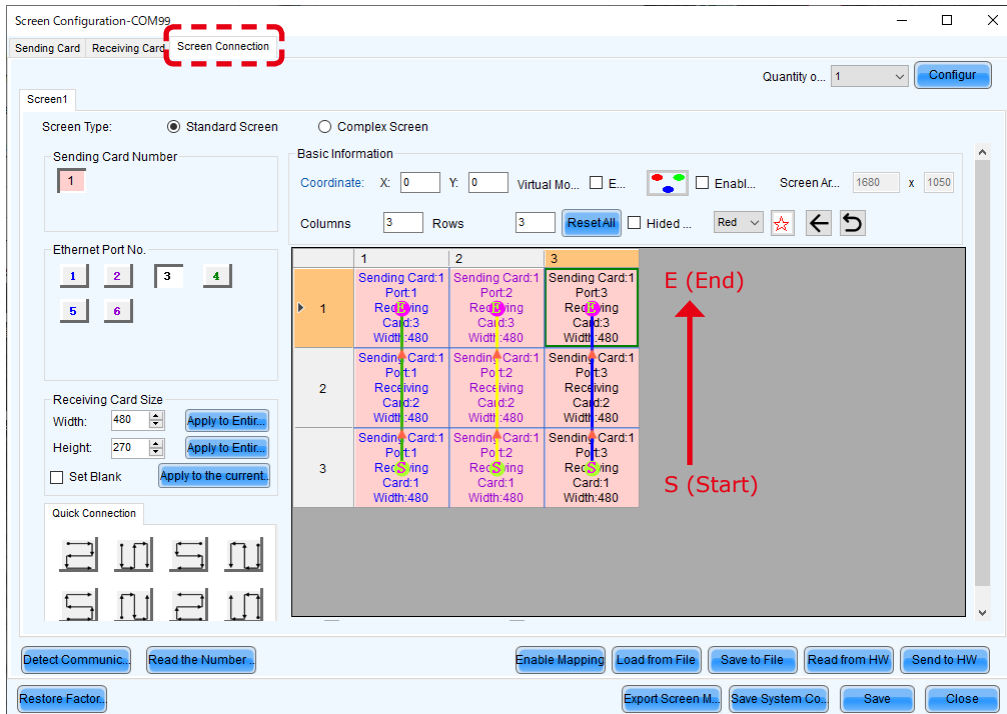

Notes on the setting operation:

Perform these setting procedures prior to the redundancy settings configuration.

Make sure that the value of "Quantity of Screens" is 1.

(To change a different value to 1, click the "Configur" button.)

It is not necessary to configure the settings for Sending Card 2.

When the settings configuration is complete, click the "Send to HW" button.

Select the Sending Card tab and click "Add".

The Redundancy Settings screen is displayed.

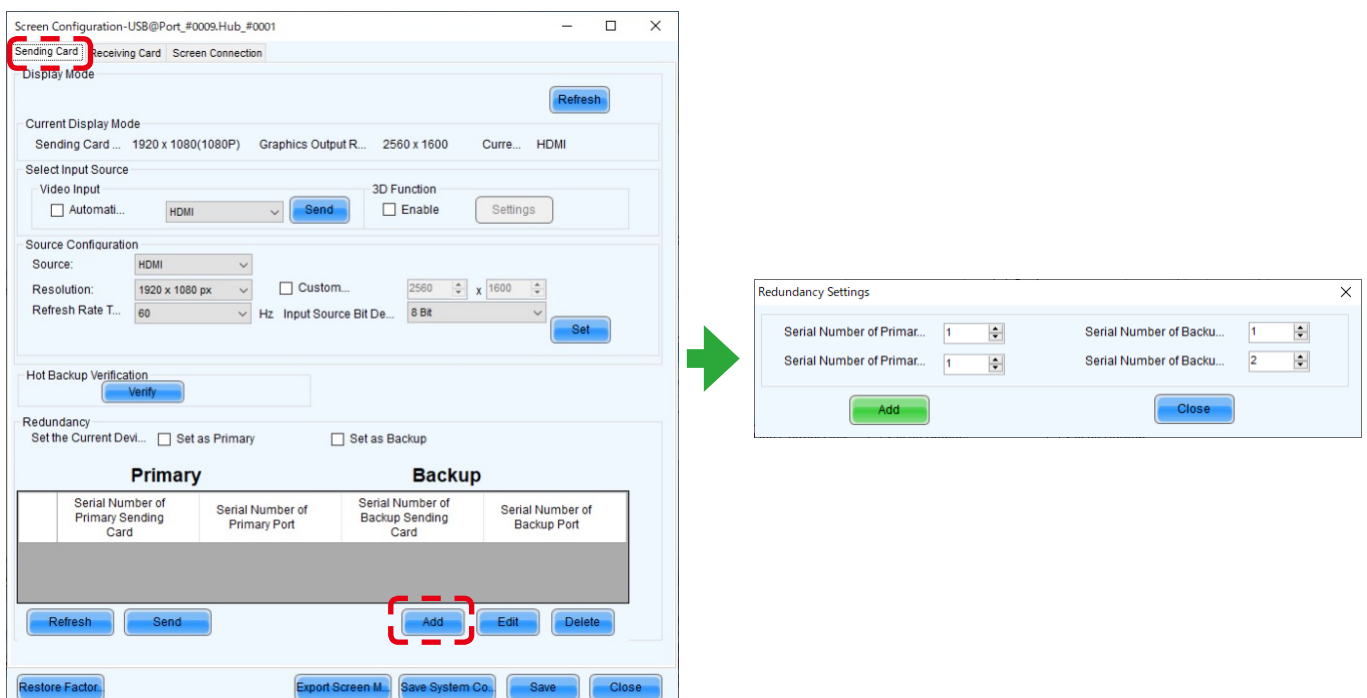

In the Redundancy Settings screen, set the Port to use on the LED controller.

In the LED configuration example ([English-84](#)), the settings are as follows. After entering the value, click the "Add" button.

Serial Number of Primary Sending Card : 1 Serial Number of Primary Port : 1 Serial Number of Backup Sending Card : 1 Serial Number of Backup Port : 4
Serial Number of Primary Sending Card : 1 Serial Number of Primary Port : 2 Serial Number of Backup Sending Card : 1 Serial Number of Backup Port : 5
Serial Number of Primary Sending Card : 1 Serial Number of Primary Port : 3 Serial Number of Backup Sending Card : 1 Serial Number of Backup Port : 6

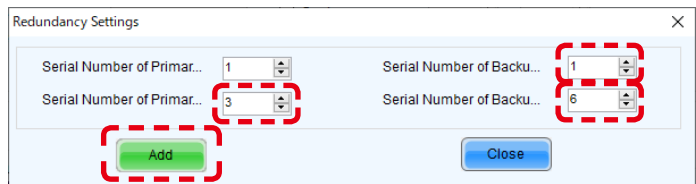
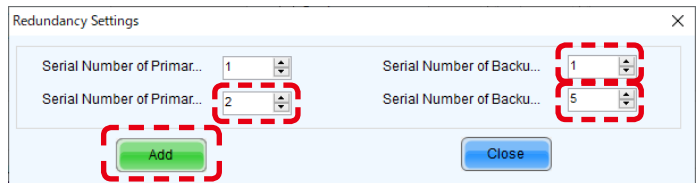
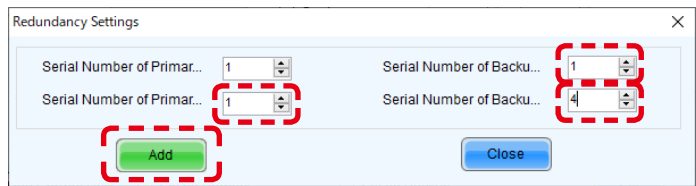

When the settings configuration is complete, the Sending Card tab appears like below.

Click the "Send" button.

Click the "Save" button.

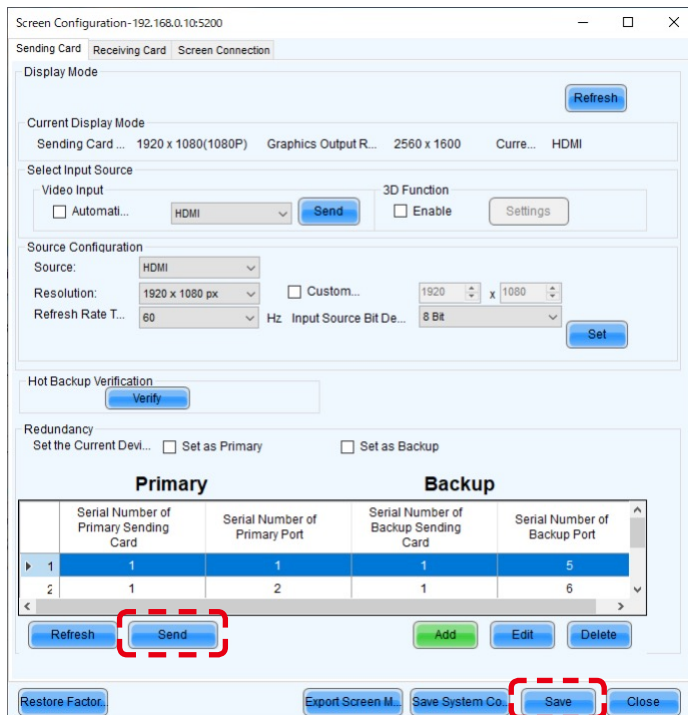

Check the current brightness setting.

Click the "Brightness" button.

In the Brightness Adjustment screen, set the desired brightness value and click the "Save to HW" button.

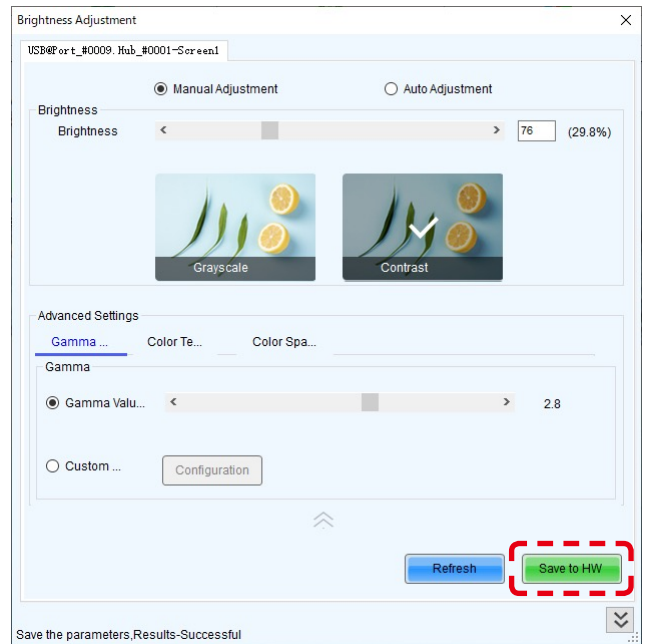
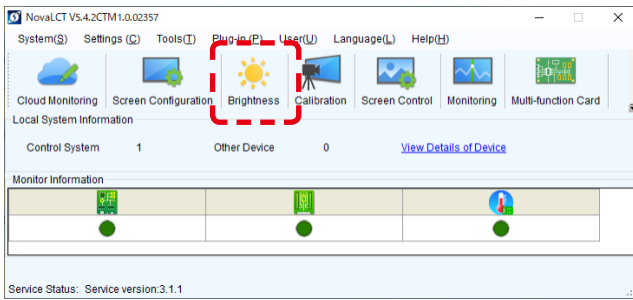

The monitoring screens appear like below.

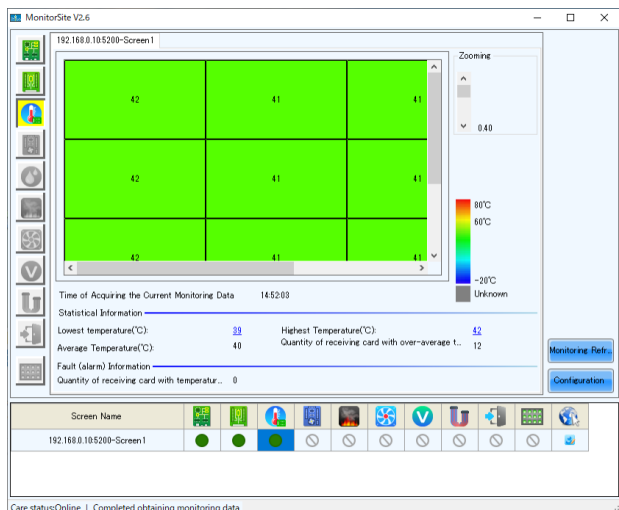
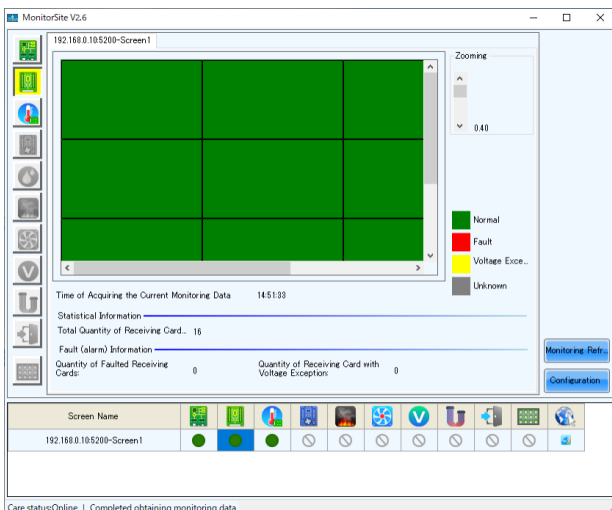
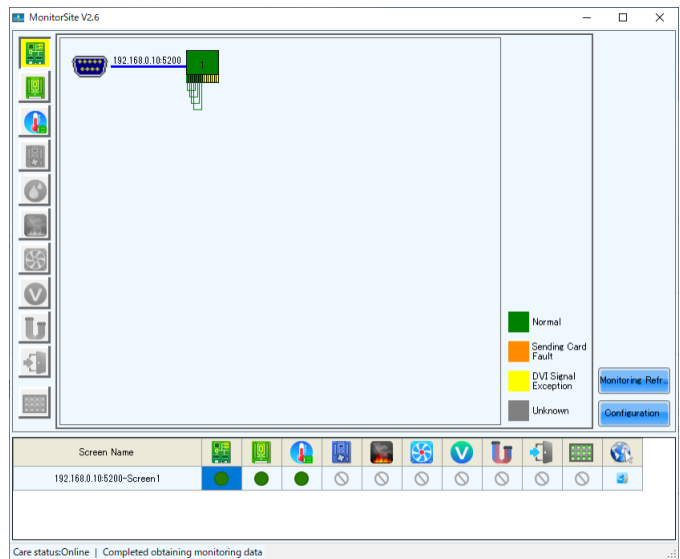
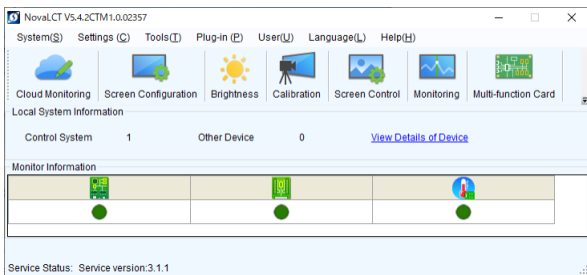

Specifications

Models for indoor use

		LED-E012i	LED-E015i	LED-E018i	LED-E025i
LED configuration		3-in-1 SMD			
Pixel pitch		1.25 mm	1.56 mm	1.88 mm	2.50 mm
Number of displayed pixels (resolution/module)		480 × 270	384 × 216	320 × 180	240 × 135
Brightness		600 cd/m ²	600 cd/m ²	800 cd/m ²	1000 cd/m ²
Contrast ratio		5000:1	4000:1	5000:1	7000:1
Brightness adjustment range		0 to 100% (256 increments)			
Gamma correction		1.0 to 4.0 (default setting: 2.8)			
Color temperature		3000 K to 9500 K (default setting: 6500 K)			
Viewing angle		Up 80°, Down 80°, Left 85°, Right 85°	Up 70°, Down 70°, Left 70°, Right 70°	Up 70°, Down 70°, Left 70°, Right 70°	Up 70°, Down 70°, Left 70°, Right 70°
Signal interface	Signal input	1 × RJ-45			
	Signal output	1 × RJ-45			
Power supply		100 V AC to 240 V AC, 50 Hz/60 Hz			
Power consumption (all white, 100% brightness)		125 W			
Ingress protection		Front IP 20 / Back IP 20			
Maintenance		Front			
Dimensions		600 × 337.5 × 29 mm			
Weight		4.7 kg			
Operating environment	Temperature	-20 to 40°C			
	Humidity	10% to 80% (without condensation)			
	Altitude	No more than 5000 m			
Storage environment	Temperature	-20 to 45°C			
	Humidity	10% to 85% (without condensation)			

Specifications are subject to change without notice.

Models for indoor use

		LED-E012i-108/ LED-E012i-10N	LED-E015i-135/ LED-E015i-13N	LED-E018i-162/ LED-E018i-16N	LED-E025i-217/ LED-E025i-21N	LED-E012i-217/ LED-E012i-21N
Module		LED-E012i 4x4	LED-E015i 5x5	LED-E018i 6x6	LED-E025i 8x8	LED-E012i 8x8
LED configuration		3-in-1 SMD				
Pixel pitch		1.25 mm	1.56 mm	1.88 mm	2.50 mm	1.25 mm
Number of displayed pixels (resolution/module)		1920 × 1080	1920 × 1080	1920 × 1080	1920 × 1080	3840 × 2160
Brightness		600 cd/m ²	600 cd/m ²	800 cd/m ²	1000 cd/m ²	600 cd/m ²
Contrast ratio		5000:1	4000:1	5000:1	7000:1	5000:1
Brightness adjustment range		0 to 100% (256 increments)				
Gamma correction		1.0 to 4.0 (default setting: 2.8)				
Color temperature		3000 K to 9500 K (default setting: 6500 K)				
Viewing angle		Up 80°, Down 80°, Left 85°, Right 85°	Up 70°, Down 70°, Left 70°, Right 70°	Up 70°, Down 70°, Left 70°, Right 70°	Up 70°, Down 70°, Left 70°, Right 70°	Up 80°, Down 80°, Left 85°, Right 85°
Signal interface	Signal input	1 × RJ-45				
	Signal output	1 × RJ-45				
Power supply		100 V AC to 240 V AC, 50 Hz/60 Hz				
Power consumption (all white, 100% brightness)		2000 W	3125 W	4500 W	8000 W	8000 W
Ingress protection		Front IP 20 / Back IP 20				
Maintenance		Front				
Dimensions		2412 × 1456 × 50 mm	3012 × 1793.5 × 50 mm	3612 × 2131 × 50 mm	4812 × 2806 × 50 mm	4812 × 2806 × 50 mm
Weight		91.2 kg	136.5 kg	196.2 kg	342.8 kg	342.8 kg
Operating environment	Temperature	-20 to 40°C				
	Humidity	10% to 80% (without condensation)				
	Altitude	No more than 5000 m				
Storage environment	Temperature	-20 to 45°C				
	Humidity	10% to 85% (without condensation)				

Diagram

LED-E012i / LED-E015i / LED-E018i / LED-E025i

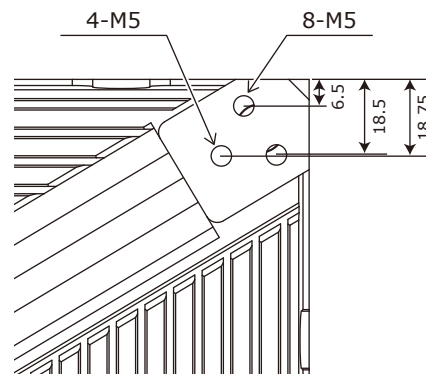
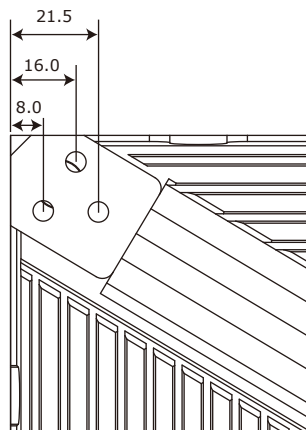
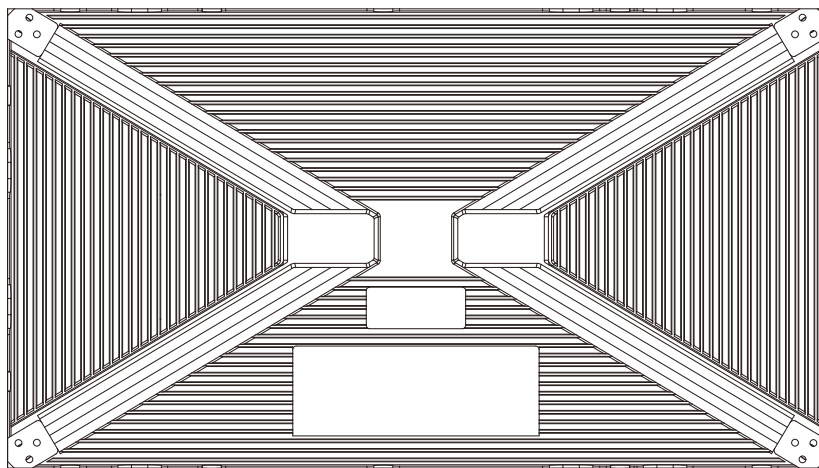
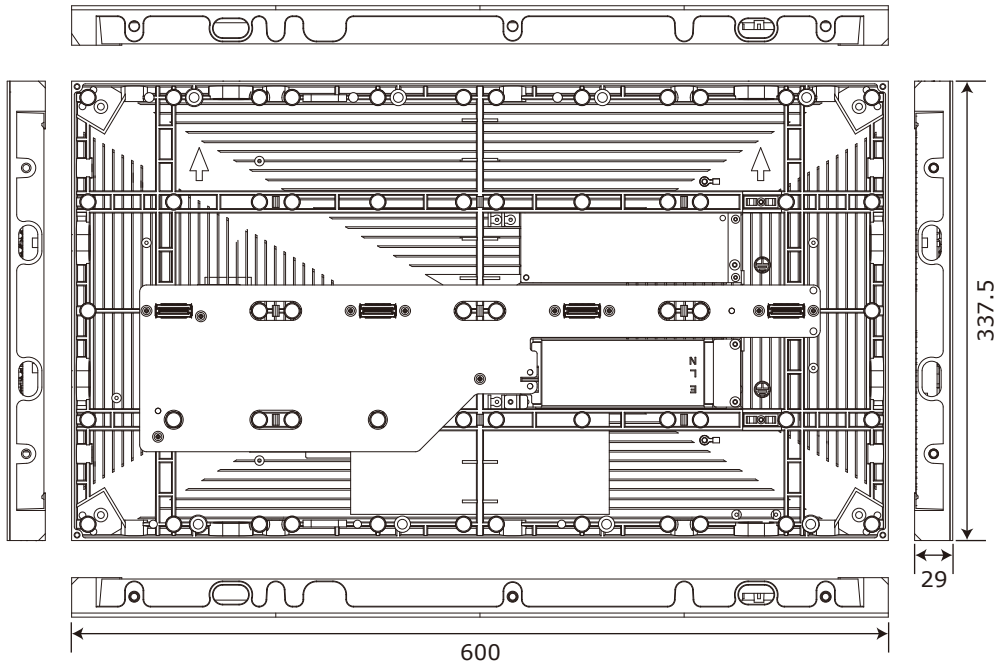

(Unit: mm)

LED-E012i / LED-E015i / LED-E018i / LED-E025i Adjustment plate

