

**Installation & Maintenance Guide**

**MD215MG**

**Disclaimer**





- \* Windows and MS-DOS are trademarks and/or registered trademarks of Microsoft Corporation in the United States and/or other countries.
- \* VESA is a trademark of the Video Electronics Standard Association.
- \* All other products and company names are trademarks of their respective owners.



# Index

Registration Information .....	English-2
Intended Use .....	English-4
Recommended use .....	English-5
Contents .....	English-7
Quick Start.....	English-8
Controls .....	English-10
OSD (On Screen Display) .....	English-10
Specifications .....	English-11
Troubleshooting.....	English-11
Additional Installation Information .....	English-12
Manufacturer's Recycling and Energy Information.....	English-17

## Symbol Information

	This symbol warns user that uninsulated voltage within the unit may have sufficient magnitude to cause electric shock. Therefore, it is dangerous to make any kind of contact with any part inside this unit.
	This symbol alerts the user that important literature concerning the operation and maintenance of this unit has been included. Therefore, it should be read carefully in order to avoid any problems.
	Protective earth terminal marked.
	Stand by.
	AC Input.

Authentication sign of Standard Inspection Bureau for U.S.A.  
Complies with UL 60601-1  
CAN/CSA C22.2 NO. 601.1.



MEDICAL ELECTRICAL EQUIPMENT WITH RESPECT  
TO ELECTRIC SHOCK, FIRE AND MECHANICAL  
HAZARDS ONLY IN ACCORDANCE WITH UL 60601-1  
AND CAN/CSA C22.2 NO.601.1 25KN.

Windows is a registered trademark of Microsoft Corporation. NEC is a registered trademark of NEC Corporation.  
ErgoDesign is a registered trademark of NEC Display Solutions, Ltd. in Austria, Benelux, Denmark, France, Germany, Italy,  
Norway, Spain, Sweden, U.K.

Adobe® is a registered trademark or trademark of Adobe Systems Incorporated in the U.S. and/or other countries.  
All other brands and product names are trademarks or registered trademarks of their respective owners.

# Registration Information

## Declaration

Declaration of the Authorized Representative		
<b>Means of Conformity</b>	NEC Display Solutions Europe GmbH declares that the product listed is in conformity with the essential requirements and provisions of the Council Directive 93/42/EEC, including the amendments of the Council Directive 2007/47/EC, and conforms to the applicable clauses of the following standards:  – EN 60601-1 – EN 60601-1-2 – EN 61000-3-2 – EN 61000-3-3 NEC Display Solutions Europe GmbH Landshuter Allee 12-14. 80637 Muenchen, Germany	
Device Classification:		Class I, non-measuring function
Applicable Rules:		Annex IX, Rules 1.4 (Section 1) and 1.1 (Section 3)
Product Name:		MD215MG 21.3" Diagnostic Imaging LCD Monitor
Model Number:		MDL2116A
UMDNS Code:	16-603	

## Canadian Department of Communications Compliance Statement

**DOC:** This Class B digital apparatus meets all requirements of the Canadian Interference-Causing Equipment Regulations.  
**C-UL:** Bears the C-UL Mark and is in compliance with Canadian Safety Regulations according to CAN/CSA C22.2 No. 601.1.

## FCC Information

- Use the attached specified cables with the MD215MG grayscale monitor so as not to interfere with radio and television reception.
  - Please use the supplied power cord or equivalent to ensure FCC compliance.
  - Please use the supplied shielded DVI-D to DVI-D cable.  
Use of other cables and adapters may cause interference with radio and television reception.
- This equipment has been tested and found to comply with the limits for a Class B digital device, pursuant to part 15 of the FCC Rules. These limits are designed to provide reasonable protection against harmful interference in a residential installation. This equipment generates, uses, and can radiate radio frequency energy, and, if not installed and used in accordance with the instructions, may cause harmful interference to radio communications. However, there is no guarantee that interference will not occur in a particular installation. If this equipment does cause harmful interference to radio or television reception, which can be determined by turning the equipment off and on, the user is encouraged to try to correct the interference by one or more of the following measures:
  - Reorient or relocate the receiving antenna.
  - Increase the separation between the equipment and receiver.
  - Connect the equipment into an outlet on a circuit different from that to which the receiver is connected.
  - Consult your dealer or an experienced radio/TV technician for help.

If necessary, the user should contact the dealer or an experienced radio/television technician for additional suggestions. The user may find the following booklet, prepared by the Federal Communications Commission, helpful: "How to Identify and Resolve Radio-TV Interference Problems." This booklet is available from the U.S. Government Printing Office, Washington, D.C., 20402, Stock No. 004-000-00345-4.

## Declaration of Conformity

This device complies with Part 15 of FCC Rules. Operation is subject to the following two conditions. (1) This device may not cause harmful interference, and (2) this device must accept any interference received, including interference that may cause undesired operation.

<b>U.S. Responsible Party:</b>	<b>NEC Display Solutions of America, Inc.</b>
<b>Address:</b>	<b>500 Park Boulevard, Suite 1100 Itasca, Illinois 60143</b>
<b>Tel. No.:</b>	<b>(630) 467-3000</b>

Type of Product: Display Monitor  
Equipment Classification: Class B Peripheral  
Model: MD215MG (MDL2116A)



*We hereby declare that the equipment specified above conforms to the technical standards as specified in the FCC Rules.*

## Classification

- \* Type of protection against electric shock: CLASS II equipment
- \* Degree of protection against electric shock: No applied part
- \* Degree of protection against ingress of water as detailed in the current edition of IEC529: IPX0 - No protection
- \* Method of sterilization or disinfection recommended by the manufacturer: Not Specified
- \* This device is not suitable for use in the presence of a flammable Anaesthetic Mixture with Air, Oxygen or Nitrous Oxide: No AP or APG category
- \* This device shall not be used in the vicinity of the patient, which is the space with surfaces likely to be contacted by the patient or an attendant who can touch the patient. This encloses a space within the room 1.83 m (6 feet) beyond the perimeter of the bed in its intended location, and extending vertically 2.29 m (7-1/2 feet) above the floor.
- \* Mode of operation: Continuous operation, maximum 16 hours/7 days

<b>WARNING</b>
<div style="display: flex; justify-content: space-between;"> <span>⚠</span> <span>⚠</span> </div> <p>TO PREVENT FIRE OR SHOCK HAZARDS, DO NOT EXPOSE THIS UNIT TO RAIN OR MOISTURE. ALSO, DO NOT USE THIS UNIT'S POLARIZED PLUG WITH AN EXTENSION CORD RECEPTACLE OR OTHER OUTLETS UNLESS THE PRONGS CAN BE FULLY INSERTED.</p> <p>REFRAIN FROM OPENING THE CABINET AS THERE ARE HIGH VOLTAGE COMPONENTS INSIDE. REFER SERVICING TO QUALIFIED SERVICE PERSONNEL.</p>

<b>CAUTION</b>
<div style="display: flex; justify-content: space-between;"> <span>⚠</span> <span>⚠</span> </div> <p>TO REDUCE THE RISK OF ELECTRIC SHOCK, MAKE SURE POWER CORD IS UNPLUGGED FROM WALL SOCKET. TO FULLY DISENGAGE THE POWER TO THE UNIT, PLEASE DISCONNECT THE POWER CORD FROM THE AC OUTLET. DO NOT REMOVE COVER (OR BACK COVER). NO USER SERVICEABLE PARTS INSIDE. REFER SERVICING TO QUALIFIED SERVICE PERSONNEL.</p>

**Power Cord Important Information**

**CAUTION:** Please use the power cord provided with this display in accordance with the table below. If a power cord is not supplied with this equipment, please contact your supplier. For all other cases, please use a power cord that matches the AC voltage of the power outlet and has been approved by and complies with the safety standard of your particular country. When you use this Display in North America, you should use a North America Hospital Grade power cord.

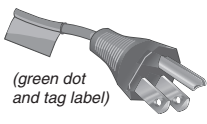
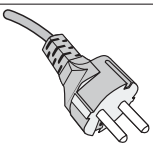
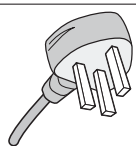
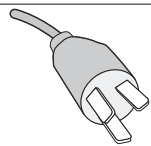
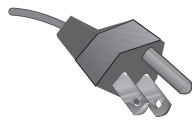
Plug Type	North America	European Continental	U.K.	Chinese	Japanese
<b>Plug Shape</b>	 <small>(green dot and tag label)</small>				
<b>Country</b>	U.S.A./Canada	EU (except U.K.)	U.K.	China	Japan
<b>Voltage</b>	120	230	230	220	100

**NOTE:** This product can only be serviced in the country where it was purchased.

# Intended Use

---

The MD215MG grayscale display is intended to be used for displaying and viewing of digital images for diagnosis, including digital mammography, by trained physicians.

**Caution:** The MD215MG grayscale display cannot be used for a life-support system.

This device is designed as component of a final system which is in compliance to IEC60601-1-1 requirements.

## Safety Precautions

This device is designed for exclusive interconnection with IEC60601-1 certified equipment outside of patient vicinity.

- Equipment connected to digital interfaces must comply with the respective IEC standards (e.g. IEC 60950 for data processing equipment and IEC 60601-1 for medical equipment).
- This device complies with EN60601-1-2. To minimize the interference from other equipment, a minimum 0.5 m distance shall be kept from other potential electromagnetic sources, such as a Cell Phone.
- To reduce the risk of electric shock, make sure that the power cord is unplugged from wall socket. To fully disengage the power to the unit, please disconnect the power cord from the AC outlet. Do not open the back cover or AC adapter. No user serviceable parts inside. Refer servicing to qualified service personnel. The AC outlet shall be readily available and accessible.

## North America Customers

Grounding reliability can only be achieved when the equipment is connected to an equivalent receptacle, marked "Hospital Only" or "Hospital Grade". That signal input port need to be connected properly and that any unused signal input port shall not be accessible for the patient to contact in the patient area after the LCD is integrated into a medical system.

Federal law restricts this device to sale by or on the order of a licensed healthcare practitioner.

## European Customers

Unpacking, Installation and calibration of this display should only be done by authorized and trained personnel. Any installation done by a non-authorized person is done under his own risk and we accept no responsibility in any device malfunctioning. To secure full functionality of this display, only NEC approved display controller models for connection with the final system must be used.

## Medical Imaging

MD215MG is designed for 2048 x 2560 medical imaging.

# Recommended use

## Safety Precautions and Maintenance



FOR OPTIMUM PERFORMANCE, PLEASE NOTE  
THE FOLLOWING WHEN SETTING UP AND  
USING THE LCD GRAYSCALE MONITOR:



- **DO NOT OPEN THE MONITOR OR AC ADAPTER.** There are no user serviceable parts inside and opening or removing covers may expose you to dangerous shock hazards or other risks. Refer all servicing to qualified service personnel.
- Do not spill any liquids into the cabinet or use your monitor near water.
- Do not insert objects of any kind into the cabinet slots, as they may touch dangerous voltage points, which can be harmful or fatal or may cause electric shock, fire or equipment failure.
- Do not place any heavy objects on the power cord. Damage to the cord may cause shock or fire.
- Do not place this product on a sloping or unstable cart, stand or table, as the monitor may fall, causing serious damage to the monitor.
- The power supply cord you use must have been approved by and comply with the safety standards of your country.
- In UK, use a BS-approved power cord with molded plug having a black (5A) fuse installed for use with this monitor.
- Do not place any objects onto the monitor and do not use the monitor outdoors.
- Use the supplied AC Adapter. Do not place any objects onto the AC Adapter and do not use the AC Adapter outdoors.
- The lamps in this product contain mercury. Please dispose according to state, local or federal law.
- Do not bend, crimp or damage the power cord.
- Do not use monitor in high temperature, humid, dusty, or oily areas.
- Do not cover vent on monitor and AC Adapter.
- Vibration can damage the backlight. Do not install the monitor where it will be exposed to continual vibration.
- If the monitor's LCD panel is broken, do not come in contact with the liquid crystal and handle with care.
- To prevent damage to the LCD monitor caused by tipping over due to earthquakes or other shocks, make sure to install the monitor in a stable location and take measures to prevent falling.

Immediately turn off the power, unplug your monitor from the wall outlet and move to a safe location then refer servicing to qualified service personnel under the following conditions. If the monitor is used in this condition, the monitor may cause fall, fire and electric shock:

- If the monitor stand has been cracked or peeled.
- If the monitor has been wobbled.
- If the monitor emanates an unusual odor.
- When the power supply cord or plug is damaged.
- When the AC Adapter is damaged.
- If liquid has been spilled, or objects have fallen into the monitor.
- If the monitor has been exposed to rain or water.
- If the monitor has been dropped or the cabinet is damaged.
- If the monitor does not operate normally by following operating instructions.



CAUTION

- Allow adequate ventilation around the monitor so that heat can properly dissipate. Do not block ventilated openings or place the monitor near a radiator or other heat sources. Do not put anything on top of monitor.
- The power cable connector is the primary means of detaching the system from the power supply. The monitor should be installed close to a power outlet which is easily accessible.
- Handle with care when transporting. Save packaging for transporting.
- Do not touch LCD panel surface while transporting, mounting and setting. Applying pressure on the LCD panel can cause serious damage.
- Carry the monitor by holding the top and the bottom of the monitor head with both hands.
- Do not carry holding only the stand.

**Image Persistence:** Image persistence exists, when a residual or “ghost” image of a previous image remains visible on the screen. Unlike with CRT monitors, image persistence on LCD monitors is not permanent, but constant images being displayed for a long period of time should be avoided.

To alleviate image persistence, turn off the monitor for as long as the previous image was displayed. For example, if an image was on the monitor for one hour and a residual image remains, the monitor should be turned off for one hour to erase the image.

**NOTE:** As with all personal display devices, NEC DISPLAY SOLUTIONS recommends using a moving screen saver at regular intervals whenever the screen is idle or turning off the monitor when not in use.

**Maintenance:** This display is factory calibrated for diagnostic imaging, in accordance with DICOM Part 14. To ensure constant visual quality over the life of this display, the recommended time interval to re-calibrate this model is 12 months.





CORRECT PLACEMENT AND ADJUSTMENT OF THE MONITOR CAN REDUCE EYE, SHOULDER AND NECK FATIGUE. CHECK THE FOLLOWING WHEN YOU POSITION THE MONITOR:



- For optimum performance, allow 20 minutes for the display to warm up.
- Adjust the monitor height so that the top of the screen is at or slightly below eye level. Your eyes should look slightly downward when viewing the middle of the screen.
- Position your monitor no closer than 40 cm (15.75 inches) and no further away than 70 cm (27.56 inches) from your eyes. The optimal distance is 50 cm (19.69 inches).
- Rest your eyes periodically by focusing on an object at least 6 m (20 feet) away. Blink often.
- Position the monitor at a 90° angle to windows and other light sources to minimize glare and reflections. Adjust the monitor tilt so that ceiling lights do not reflect on your screen.
- Position whatever you are looking at most of the time (the screen or reference material) directly in front of you to minimize turning your head.
- Avoid displaying fixed patterns on the monitor for long periods of time to avoid image persistence (after-image effects).
- Get regular eye checkups.

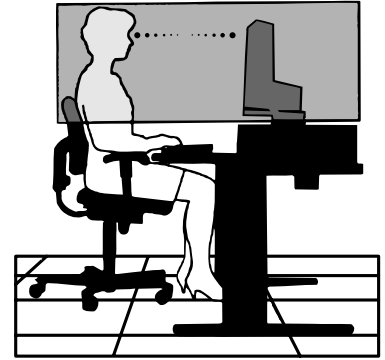

#### **Cleaning the LCD Protection Glass**

- When the protection glass is dusty, gently clean the surface with a lint-free, non-abrasive cloth.
- Avoid using any OA cleaner, other cleaning solution or glass cleaner. This will cause deterioration or discoloration of the LCD protection glass.
- Please do not apply pressure to the LCD protection glass.

#### **Cleaning the Cabinet**

- Unplug the power supply cord from the wall outlet.
- Gently wipe the cabinet with a soft cloth.
- To clean the cabinet, dampen the cloth with a neutral detergent and water, wipe the cabinet and follow with a dry cloth.

**NOTE:** Many plastics are used on the surface of the cabinet. DO NOT clean with benzene, thinner, alkaline detergent, alcoholic system detergent, glass cleaner, wax, polish cleaner, soap powder, or insecticide. Do not touch rubber or vinyl to the cabinet for a long time. These types of fluids and fabrics can cause the paint to deteriorate, crack or peel.

# Contents

Your new NEC monitor box\* should contain the following:

- MD215MG monitor with tilt/swivel/pivot/height adjust stand
- Power Cord
- Video Signal Cable (DVI-D to DVI-D cable)\*<sup>1</sup>
- AC adapter MW122
- USB Cable
- Quick Reference Guide

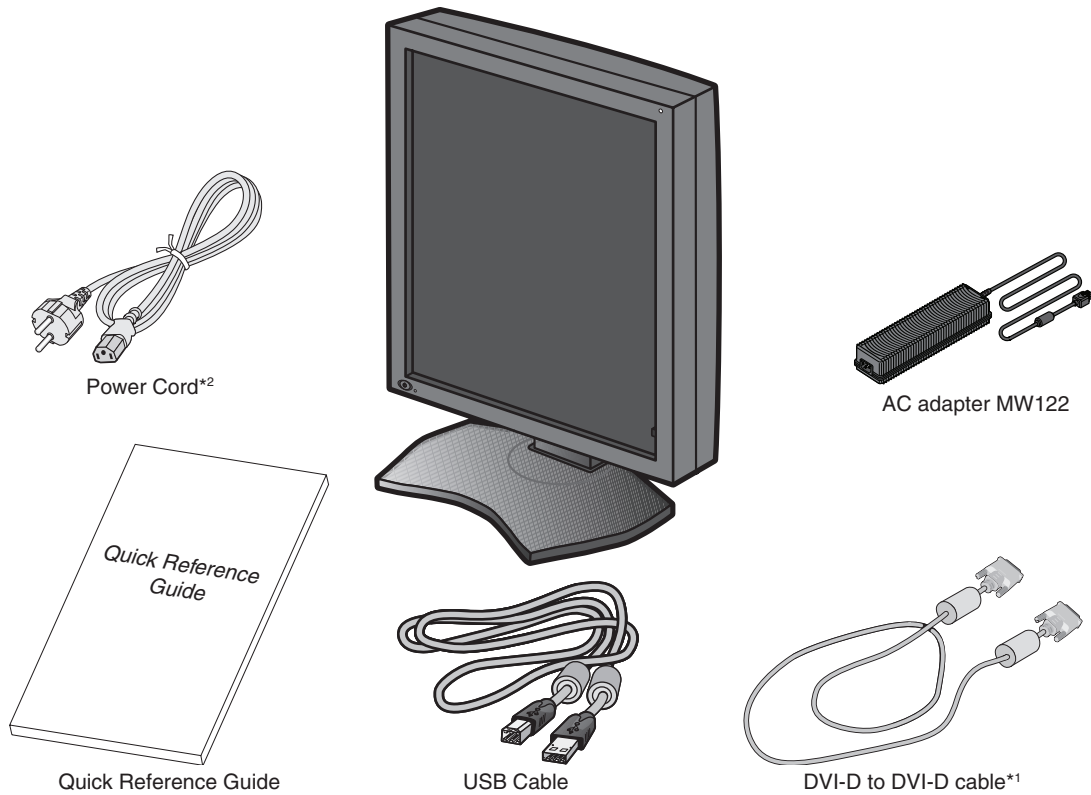

\* Remember to save your original box and packing material to transport or ship the monitor.

\*<sup>1</sup> Dual link DVI cable.

\*<sup>2</sup> Type and number of power cords included will depend on the where the LCD monitor is to be shipped. When more than one power cord is included, please use a power cord that matches the AC voltage of the power outlet and has been approved by and complies with the safety standard of your particular country.

# Quick Start

To connect the LCD monitor to your system, follow these instructions:

**NOTE:** Make sure to read "Recommended Use" before installation.  
In order to display the maximum resolution, a display controller that can output a resolution of 2048 x 2560 is needed.

1. Turn off the power to your computer.
2. **For a PC with DVI digital output:** Connect the DVI signal cable to the connector of the display controller in your system (**Figure A**). Tighten all screws.

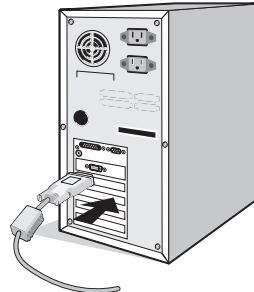

Figure A

3. Remove the cable cover (**Figure B**).  
To remove the cable cover, unlock the slide latch (1) on the cable cover (2) and slide the cover to the side to remove it.

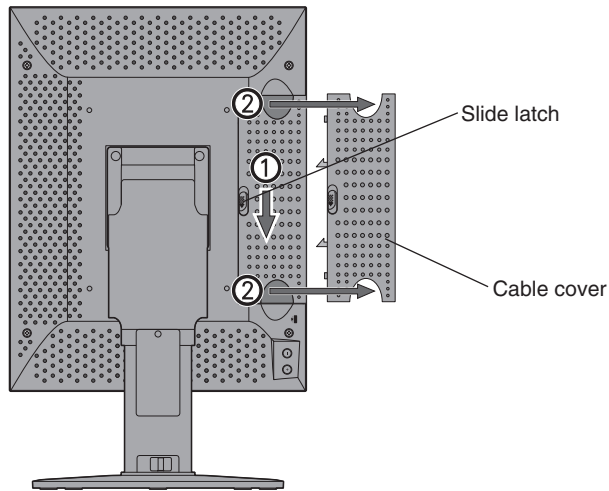

Figure B

4. Connect all cables to the appropriate connectors (**Figure C**).

**NOTE:** Incorrect cable connections may result in irregular operation, damage display quality/components of LCD module and/or shorten the module's life.

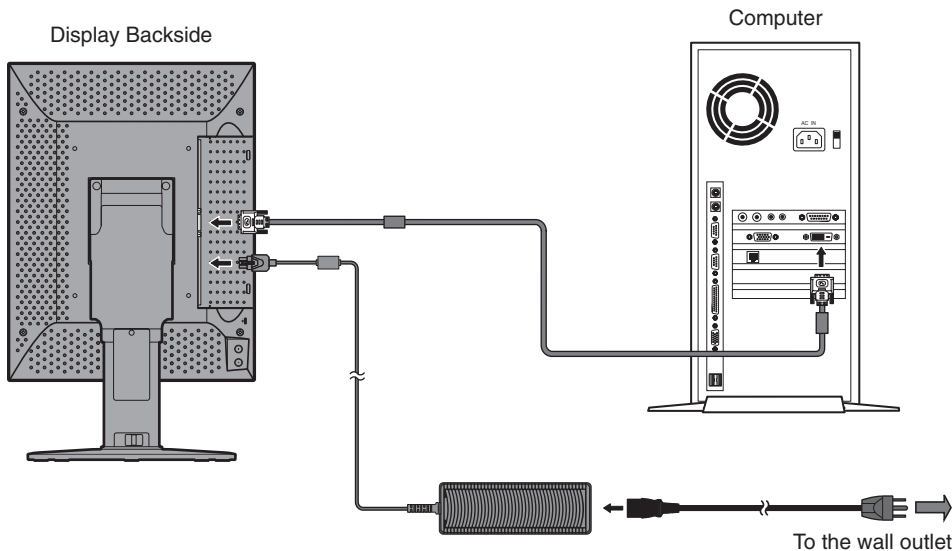
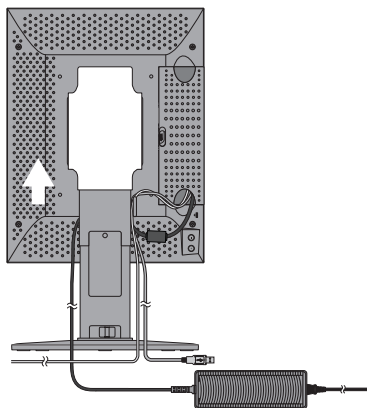

Figure C

5. To keep the cables neatly organized, place them into the cable management system that is built into the stand. Place the cables in the hooks firmly and evenly (**Figure D**).



**Figure D**

6. Slide down the cable cover (**Figure E**).
7. Please check that you can still rotate, raise and lower the monitor screen, when you have installed the cables.

**NOTE:** Handle with care when raising, lowering, rotating or tilting the monitor screen.

8. Connect the AC adapter with the proper AC cord, then plug the AC cord to the power outlet.

**NOTE:** Please refer to the CAUTION section of this Installation & Maintenance Guide for proper selection of AC power cord.

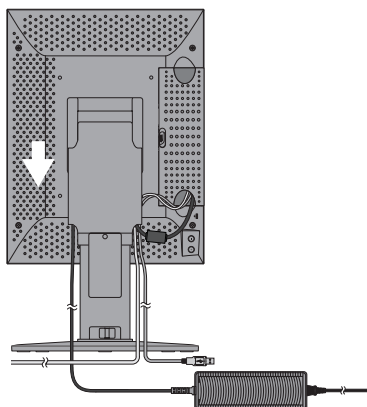

**Figure E**

9. Turn on the monitor with the front power button (**Figure F**) and the computer.

**NOTE:** If you have any problems, please refer to the **Troubleshooting** section of this Installation & Maintenance Guide.

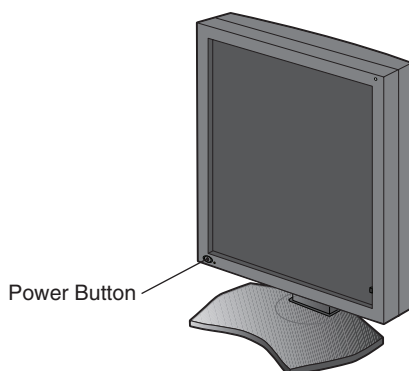

**Figure F**

# Controls

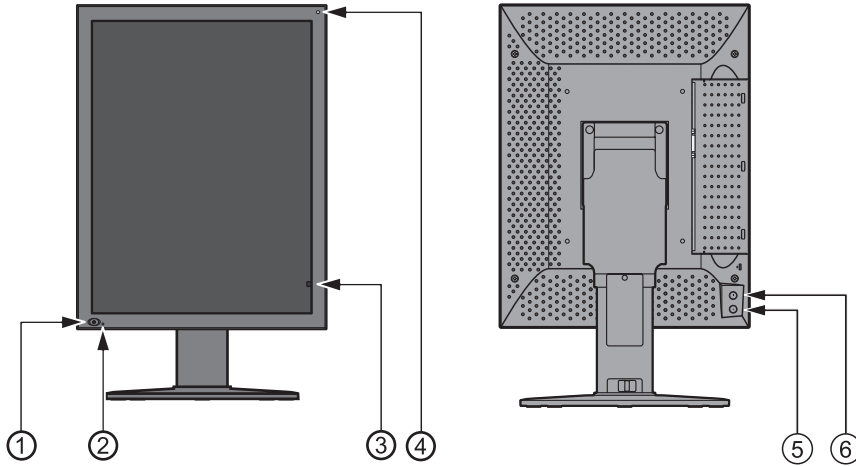

1 Power Switch	To turn the monitor on and off.
2 LED	Indicates that the power is on. Turns off automatically, when the luminance is stabilized.
3 Front Sensor	For luminance stabilization and calibration.
4 Ambient Light Sensor	Measures ambient light during calibration process.
5 + (plus) Button	To open the OSD (On Screen Display) 1 <sup>st</sup> click – Display information 2 <sup>nd</sup> click – Present operating state 3 <sup>rd</sup> click – OSD off (otherwise OSD disappears in 15 sec.)
6 – (minus) Button	Same as + (plus) Button

# OSD (On Screen Display)

Model

Serial Number

Maintenance Information

Total Operating Hours

Operating Hours Since The Last Calibration

EDID Data Status

Display Mode

**Display information**

```

INFORMATION
MODEL       : MD215MG
SERIAL      : *****
VSPU       : REV.01
MPU        : REV. A
ACT TIME   : XXXXX H
LAST CAL   : XXXXX H
EDID       : Portrait
DSP MODE   : Normal
            
```

Current Luminance

Configuration Number

Luminance Setting

Gamma Setting

**Present operating state**

```

PRESENT STATE
LUMINANCE  : 401
CALIBRATION SETTING
CONFIG     : 1
LUMNANCE   : 400
GAMMA      : DICOM GSDF
            
```

# Specifications

Monitor Specifications	MD215MG	Notes
LCD panel color	Clear Base	
LCD	21.3-inch (54 cm), monochrome, TFT active matrix, anti-glare	
Pixel pitch (H x V)	0.165 x 0.165 mm	
Display area (H x V)	337.9 x 422.4 mm	
Pixel (H x V)	2048 x 2560	
Grayscale	256 steps of gray out of a palette of 3826 10-bit (1024) simultaneously displayable grayscale in packed pixel mode	
Backlight	12 cold cathode fluorescent lamps (CCFL)	
LCD Optical characteristics (typ.)	Viewing angle: 170° horizontal/vertical (contrast ratio ≥ 20:1) Contrast ratio: 850:1 (Viewing angle perpendicular to LCD panel)	
Luminance	DICOM calibrated	400 cd/m <sup>2</sup> as factory default
	Maximum	500 cd/m <sup>2</sup> (1100 cd/m <sup>2</sup> typ. as LCD component)
Input sync signal	DVI 1.0 compliant	
Available resolution	640 x 480 800 x 600 1024 x 768 2048 x 2560 (at Fv=25/50Hz) 2560 x 2048 (at Fv=25/50Hz)	
Input connectors	DVI 24-pin connector, 6-pin DC power input terminal	
USB Hub	USB Rev. 2.0 compliant, Self-powered USB upstream port (x1), USB downstream ports (x2)	
Ambient conditions	Temperature: On: 5 ~ 40°C, Off: -20 ~ 60°C Humidity (no condensation): On: 30 ~ 80%, Off: 10 ~ 85% Air pressure: On: 700 ~ 1060hPa, Off: 266 ~ 1060hPa	
Power	Display: DC 12V, 10A AC Adapter MW122: Input: AC 100 to 240V, 50/60 Hz, 2A Output: DC 12V, 10A	
Power consumption	Normal: Approx. 90W (w/ supplied AC adapter) Power saved: Less than 10W (w/ supplied AC adapter)	
Dimensions & weight (W x H x D)	Net: 390 x 487.8/584 x 227.6 mm (W x H x D: Portrait) approx. 11.1 kg Packed: 475 x 705 x 345 mm (W x H x D). approx. 15 kg	
Safety certifications	UL60601-1, CSA C22.2 No.601.1, FCC-B, CE-MDD, VCCI-B	

**NOTE:** Technical specifications are subject to change without notice.

## Troubleshooting

### The display won't turn on! (The power indicator is off.)

- Make sure the display is plugged.
- Check to see if the display is turned on.

### The screen is not lit!

- Check if cables are connected correctly.
- Check if the computer is turned on.
- If the LED indicator is orange, the computer may be in power saving mode. Press any key on the keyboard to wake up the computer.
- The input signal frequency or display resolution may not be appropriate for the display. Refer to the computer instruction manual and adjust the frequency and/or resolution.
- If the LED is red, this may be an error indication. Contact your supplier.

### Images are not displayed properly!

- The display resolution may not be appropriate for the display. Refer to the computer instruction manual and adjust resolution.

### The refresh rate is set to 50Hz (dual-link mode) and resolution loss (scan line gaps) occurs!

- This can happen when a single-link cable or a DisplayPort to Single Link adapter is used. Use the supplied dual-link cable which supports both single-link (25Hz) and dual-link (50Hz) modes, or set the refresh rate to 25Hz.

# Additional Installation Information

## Advanced OSD

Several control functions are available by entering the advanced OSD. These control functions are additional OSD menu items, which are always accessible after opening the standard OSD.

Control Function	Description																											
<b>EDID</b>	Change the picture format to be recognized by the operating system <ul style="list-style-type: none"> <li>• <b>Portrait format</b> - 2048 x 2560 pixels [Factory Default]</li> <li>• <b>Landscape format</b> - 2560 x 2048 pixels</li> </ul>																											
<b>Display Mode</b>	Change the video signal input format <ul style="list-style-type: none"> <li>• <b>Normal Mode</b> [Factory Default] The display accepts the video signal with either 25Hz refresh rate (DVI Single Link) or 50Hz refresh rate (DVI Dual Link), based on DVI 1.1 specifications.</li> <li>• <b>Packed Pixel Mode</b> The display accepts the video signal with 50Hz refresh rate in a special packed pixel data format (DVI Single Link). This requires the use of a customized driver for the display controller. Make sure that a customized driver is available for your specific display controller model. For the availability of a packed pixel driver, please contact your supplier.</li> </ul>																											
<b>Configuration</b>	Change luminance and gamma correction factory presets. The factory presets are: <table border="1" style="margin: 10px auto;"> <thead> <tr> <th rowspan="2">Configuration</th> <th colspan="3">Luminance (cd/m<sup>2</sup>)</th> <th rowspan="2">Gamma</th> <th rowspan="2">Remark</th> </tr> <tr> <th>Maximum</th> <th>Minimum</th> <th>Ambient</th> </tr> </thead> <tbody> <tr> <td>1</td> <td>400</td> <td>1.0</td> <td>0.0</td> <td>DICOM</td> <td>Default</td> </tr> <tr> <td>2</td> <td>430</td> <td>1.5</td> <td>0.0</td> <td>DICOM</td> <td></td> </tr> <tr> <td>3</td> <td>500</td> <td>1.0</td> <td>0.0</td> <td>DICOM</td> <td></td> </tr> </tbody> </table> <p>These parameter may be modified anytime by a new display calibration.</p> <p><b>NOTE:</b> Regarding display calibration, please refer to the MD215MG Calibrator Manual.</p>	Configuration	Luminance (cd/m <sup>2</sup> )			Gamma	Remark	Maximum	Minimum	Ambient	1	400	1.0	0.0	DICOM	Default	2	430	1.5	0.0	DICOM		3	500	1.0	0.0	DICOM	
Configuration	Luminance (cd/m <sup>2</sup> )			Gamma	Remark																							
	Maximum	Minimum	Ambient																									
1	400	1.0	0.0	DICOM	Default																							
2	430	1.5	0.0	DICOM																								
3	500	1.0	0.0	DICOM																								

## How to change the EDID setting (Portrait / Landscape)

1. Click the (+) plus button or (-) minus button on the back side of the monitor once to display the "INFORMATION" OSD. A display, which is similar to this picture, opens on the screen.

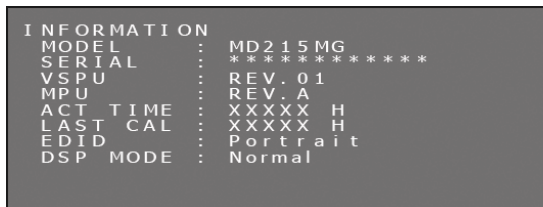

2. Hold down the (+) plus button and the (-) minus button simultaneously for over 2 seconds. The "SWITCHING EDID" menu opens on the screen. Select "Portrait" or "Landscape" by the (+) plus button or the (-) minus button.



- After selecting your preferred EDID mode, hold down the (+) plus button and the (-) minus button simultaneously for over 2 seconds again. Then confirm the EDID line (Portrait/Landscape) on the "INFORMATION" OSD.

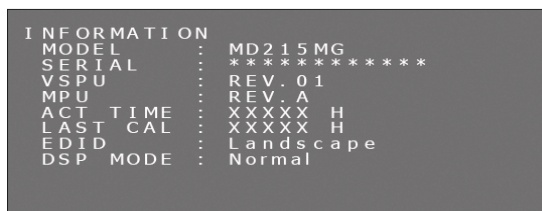

- Click the (+) plus button or (-) minus button once to close the "INFORMATION" OSD.

**NOTE:** When using the "Portrait" setting, the display controller does not need to rotate the image in the video ram. In most applications, this setting is preferable. However, if there is a need to rotate the image by the display controller, the "Landscape" setting may be preferable.

### How to Change the Display Mode (Normal/Packed Pixel)

- Click the (+) plus button or (-) minus button on the back side of the monitor once to display the "INFORMATION" OSD. A display, which is similar to this picture, opens on the screen.

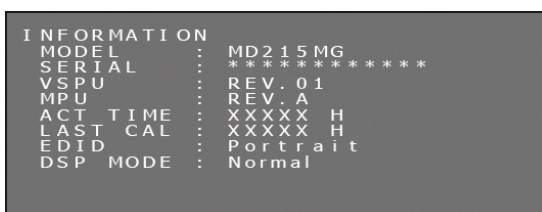

- Hold down the (+) plus button and the (-) minus button simultaneously for over 2 seconds. The "SWITCHING EDID" menu opens on the screen.



- Press the power switch  on the front of the monitor once to display the "SWITCHING DISPLAY MODE" menu. Select "Normal" or "Packed Pixel" by the (+) plus button or the (-) minus button.

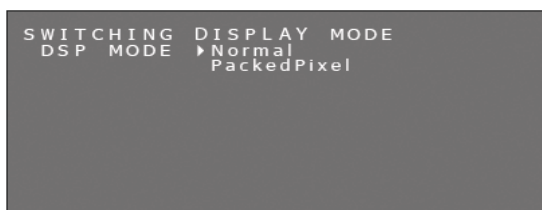

Note: By pressing the power switch , the OSD information changes as below.

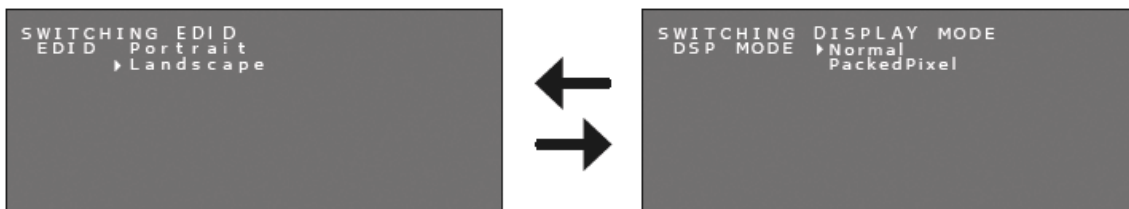

- After selecting your preferred Display Mode, hold down the (+) plus button and the (-) minus button simultaneously for over 2 seconds again. Then confirm the DSP MODE line (Normal/PackedPixel) on the "INFORMATION" OSD.

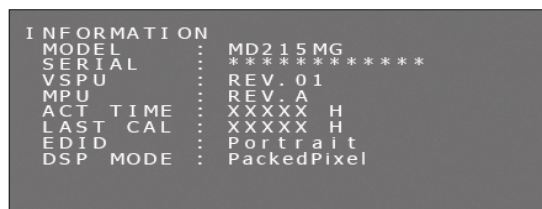

- Click the (+) plus button or (-) minus button once to close the "INFORMATION" OSD.



## How to Change Configuration (Preset 1, 2, 3)

The NEC model MD215MG is shipped with 3 factory preset configurations, as listed below.

Configuration	Luminance (cd/m <sup>2</sup> )			Gamma	Remark
	Maximum	Minimum	Ambient		
1	400	1.0	0.0	DICOM	[Factory Default]
2	430	1.5	0.0	DICOM	
3	500	1.0	0.0	DICOM	

The configuration can be changed via an OSD menu. These parameters may be modified anytime by a new display calibration. Regarding display calibration, please refer to the *MD215MG Calibrator Manual*.

- Click the (+) plus button or (-) minus button on the back side of the monitor twice to display the "PRESENT STATE" OSD. A display like this picture opens on the screen.



- Hold down the (+) plus button and the (-) minus button simultaneously for over 2 seconds. The "SWITCHING CONFIGURATION" menu opens on the screen.

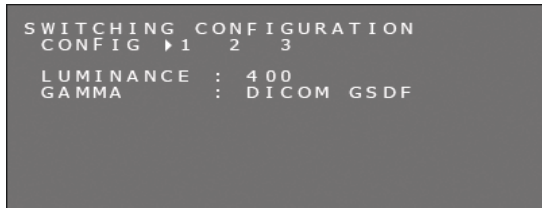

- Select your desired configuration by the (+) plus button or the (-) minus button.

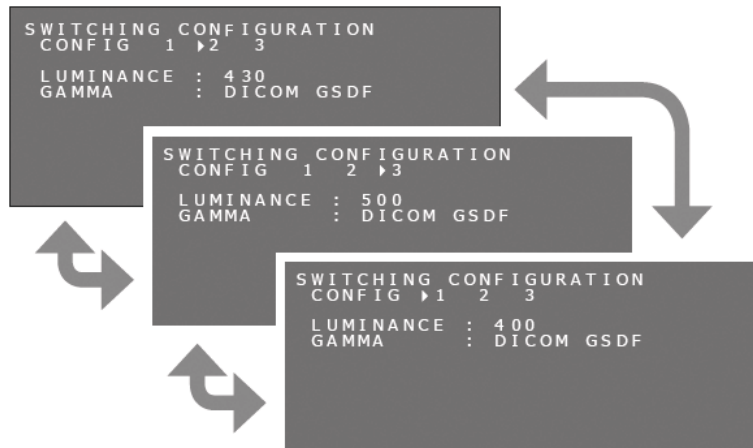

- After selecting your preferred CONFIGURATION mode, hold down the (+) plus button and the (-) minus button simultaneously for over 2 seconds again. Then confirm any change of configuration in the "PRESENT STATE" OSD.

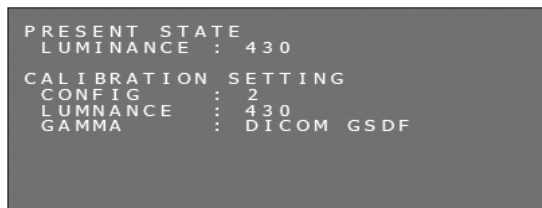

- Click the (+) plus button or (-) minus button once to close the "PRESENT STATE" OSD.

## Advanced OSD Controls without video input

If no video signal is available, the display enters the power save mode and the OSD cannot be displayed. In this case, please follow the procedure below.

1. Confirm that the display is in power save mode and the LED next to the power switch is lit orange. If the LED is off, please push the power switch to turn on the monitor.

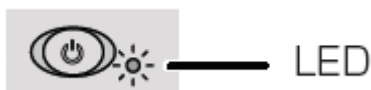

2. Hold down the (+) plus button and the (-) minus button simultaneously for over 2 seconds. The "INFORMATION" OSD menu opens on the screen. The LED color changes from Orange to Green.

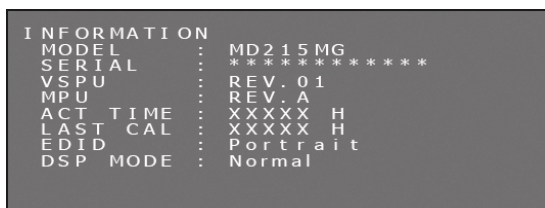

3. Switch EDID, Display Mode or Configuration referring to this manual.
  - How to Change the EDID settings (see page 12)
  - How to Change the Display Mode (see page 13)
  - How to Change Configuration (see page 14)
4. If the display enters the power save mode during the change process, please start from the beginning again.

## Attaching a wall mount or multi-display mounting arm

The tilt and swivel stand, as shipped with the display, is interchangeable with commercially available wall mounts or multi-display mounting arms that:

- Come with a mount plate with 4 slotted screw holes at 100 mm x 100 mm and
- Can bear the total weight of the LCD panel (without the stand) and the cables connected to it.

For more information ask your mounting arm supplier.

**Note:** Use the original screws to use the LCD panel back on its original tilt stand.

<b>CAUTION</b>					
<p>Choose the screw size carefully according to the mount plate thickness. If the screws are too long, they could damage the internal parts. If they are too short, the connection becomes loose and the display could fall out.</p>	<table border="1"> <thead> <tr> <th>Mounting plate thickness</th> <th>Screw size</th> </tr> </thead> <tbody> <tr> <td style="text-align: center;">1.5-4.0mm</td> <td style="text-align: center;">ISO M4x16</td> </tr> </tbody> </table>	Mounting plate thickness	Screw size	1.5-4.0mm	ISO M4x16
Mounting plate thickness	Screw size				
1.5-4.0mm	ISO M4x16				

### How to attach wall mounts or multi-display mounting arms

1. Place a soft cloth or cushioning material over a stable even surface.
2. Put the display face down on the soft cloth or cushioning material.
3. Remove 4 screws and detach the tilt and swivel stand shipped with the display.
4. Attach the wall mount or multi-display mounting arm according to the manufacturer's instructions.

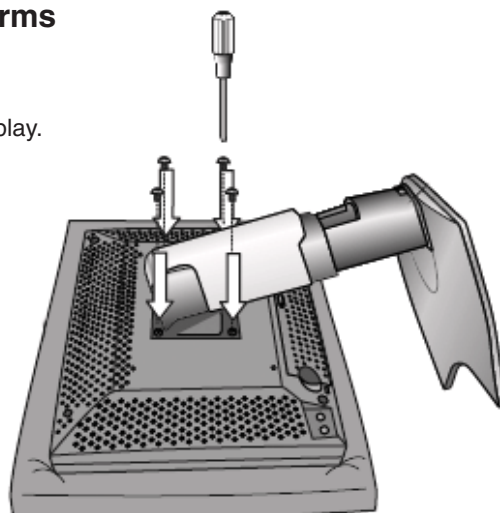

## Antitheft Security Slot

The display is equipped with the security slot supported by MicroSaver Security Lock System by Kensington Technology Group. The MicroSaver locks are available at PC supply stores.

**Note:** Kensington is the registered trademark of Kensington Technology Group.

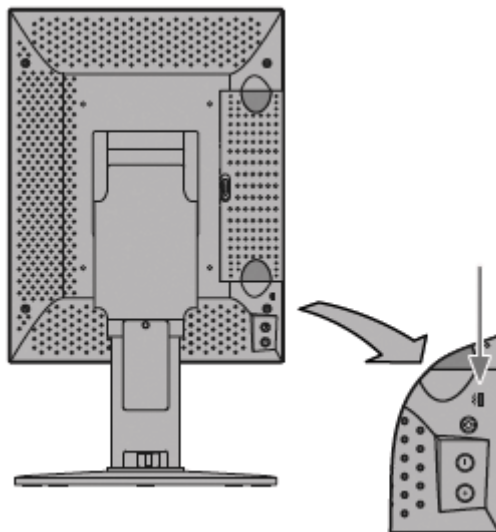

# Manufacturer's Recycling and Energy Information

NEC DISPLAY SOLUTIONS is strongly committed to environmental protection and sees recycling as one of the company's top priorities in trying to minimize the burden placed on the environment. We are engaged in developing environmentally-friendly products, and always strive to help define and comply with the latest independent standards from agencies such as ISO (International Organisation for Standardization).

## Disposing of your old NEC product

The aim of recycling is to gain an environmental benefit by means of re-use, upgrading, reconditioning or reclamation of material. Dedicated recycling sites ensure that environmentally harmful components are properly handled and securely disposed. To ensure the best recycling of our products, **NEC DISPLAY SOLUTIONS offers a variety of recycling procedures** and gives advice on how to handle the product in an environmentally sensitive way, once it has reached the end of its life.

All required information concerning the disposal of the product and country-specific information on recycling facilities can be found on our following websites:

<http://www.nec-display-solutions.com> (in Europe),

<http://www.nec-display.com> (in Japan) or

<http://www.necdisplay.com> (in USA).

## Energy Saving

This monitor features an advanced energy saving capability.

Mode	Power consumption	LED colour
Normal Operation	Approx. 90 W	Green (then unlit when luminance is stabilized)
Energy Saving Mode	Less than 10 W	Orange
Off Mode	Less than 10 W	Unlit

## WEEE Mark (European Directive 2002/96/EC)



### Within the European Union

EU-wide legislation, as implemented in each Member State, requires that waste electrical and electronic products carrying the mark (left) must be disposed of separately from normal household waste. This includes monitors and electrical accessories, such as signal cables or power cords. When you need to dispose of your NEC display products, please follow the guidance of your local authority, or ask the shop where you purchased the product, or if applicable, follow any agreements made between yourself and NEC.

The mark on electrical and electronic products only applies to the current European Union Member States.

### Outside the European Union

If you wish to dispose of used electrical and electronic products outside the European Union, please contact your local authority so as to comply with the correct disposal method.

# NEC

NEC Display Solutions, Ltd.  
MS Shibaura Building,  
13-23, Shibaura 4-chome, Minato-ku,  
Tokyo 108-0023  
Japan

NEC Display Solutions of America  
500 Park Blvd. Suite 1100 Itasca,  
Illinois 60143  
USA  
Phone: 630.467.3000  
Fax: 630.467.3010

NEC Display Solutions Europe GmbH  
Landshuter Allee 12-14  
D-80637 Muenchen  
Germany  
Phone: +49(0)89/99699-0  
Fax: +49(0)89/99699-500

Vol. 1, 1<sup>st</sup> Edition, March 2011