

**NEC**

# ***LT170***

***Portable Projector***

***User's Manual***



# IMPORTANT INFORMATION

## Safety Cautions

### Precautions

Please read this manual carefully before using your NEC LT170 Projector and keep the manual handy for future reference. Your serial number is located on the bottom of your projector. Record it here:



#### CAUTION

To turn off main power, be sure to remove the plug from power outlet.

The power outlet socket should be installed as near to the equipment as possible, and should be easily accessible.



#### CAUTION

TO PREVENT SHOCK, DO NOT OPEN THE CABINET.

NO USER-SERVICEABLE PARTS INSIDE.

REFER SERVICING TO QUALIFIED NEC SERVICE PERSONNEL.



This symbol warns the user that uninsulated voltage within the unit may be sufficient to cause electrical shock. Therefore, it is dangerous to make any kind of contact with any part inside of the unit.



This symbol alerts the user that important information concerning the operation and maintenance of this unit has been provided.

The information should be read carefully to avoid problems.

#### WARNING

TO PREVENT FIRE OR SHOCK, DO NOT EXPOSE THIS UNIT TO RAIN OR MOISTURE.

DO NOT USE THIS UNIT'S PLUG WITH AN EXTENSION CORD OR IN AN OUTLET UNLESS ALL THREE PRONGS CAN BE FULLY INSERTED.

DO NOT OPEN THE CABINET. THERE ARE HIGH-VOLTAGE COMPONENTS INSIDE. ALL SERVICING MUST BE DONE BY QUALIFIED NEC SERVICE PERSONNEL.

### DOC Compliance Notice

This Class B digital apparatus meets all requirements of the Canadian Interference-Causing Equipment Regulations.

### Acoustic Noise Information Ordinance-3. GSGV:

The sound pressure level is less than 70 dB (A) according to ISO 3744 or ISO 7779.

#### WARNING TO CALIFORNIA RESIDENTS:

Handling the cables supplied with this product, will expose you to lead, a chemical known to the State of California to cause birth defects or other reproductive harm. Wash hands after handling.

## RF Interference

#### WARNING

The Federal Communications Commission does not allow any modifications or changes to the unit EXCEPT those specified by NEC Solutions (America), Inc. in this manual. Failure to comply with this government regulation could void your right to operate this equipment. This equipment has been tested and found to comply with the limits for a Class B digital device, pursuant to Part 15 of the FCC Rules. These limits are designed to provide reasonable protection against harmful interference in a residential installation. This equipment generates, uses, and can radiate radio frequency energy and, if not installed and used in accordance with the instructions, may cause harmful interference to radio communications. However, there is no guarantee that interference will not occur in a particular installation. If this equipment does cause harmful interference to radio or television reception, which can be determined by turning the equipment off and on, the user is encouraged to try to correct the interference by one or more of the following measures:

- Reorient or relocate the receiving antenna.
- Increase the separation between the equipment and receiver.
- Connect the equipment into an outlet on a circuit different from that to which the receiver is connected.
- Consult the dealer or an experienced radio / TV technician for help.

In UK, a BS approved power cable with moulded plug has a Black (five Amps) fuse installed for use with this equipment. If a power cable is not supplied with this equipment please contact your supplier.

### Important Safeguards

These safety instructions are to ensure the long life of your projector and to prevent fire and shock. Please read them carefully and heed all warnings.

### Installation

1. For best results, use your projector in a darkened room.
2. Place the projector on a flat, level surface in a dry area away from dust and moisture.  
To avoid premature lamp failure, do not tilt the front of the projector up or down by more than 10° from level.
3. Do not place your projector in direct sunlight, near heaters or heat radiating appliances.
4. Exposure to direct sunlight, smoke or steam can harm internal components.
5. Handle your projector carefully. Dropping or jarring can damage internal components.
6. Do not place heavy objects on top of the projector.
7. If you wish to have the projector installed on the ceiling:
  - a. Do not attempt to install the projector yourself.
  - b. The projector must be installed by qualified technicians in order to ensure proper operation and reduce the risk of bodily injury.
  - c. In addition, the ceiling must be strong enough to support the projector and the installation must be in accordance with any local building codes.
  - d. Please consult your dealer for more information.
8. Do not use the projector upside down on the surface of a tall cabinet, a table, or a floor. Doing so can hit the POWER button before you notice.

**Fire and Shock Precautions**

1. Ensure that there is sufficient ventilation and that vents are unobstructed to prevent the build-up of heat inside your projector. Allow at least 4 inches (10 cm) of space between your projector and a wall.
2. Prevent foreign objects such as paper clips and bits of paper from falling into your projector.  
Do not attempt to retrieve any objects that might fall into your projector. Do not insert any metal objects such as a wire or screwdriver into your projector. If something should fall into your projector, disconnect it immediately and have the object removed by a qualified NEC service personnel.
3. Do not place any liquids on top of your projector.
4. Do not look into the lens while the projector is on. Serious damage to your eyes could result.
5. Keep any items such as magnifying glass out of the light path of the projector. The light being projected from the lens is extensive, therefore any kind of abnormal objects that can redirect light coming out of the lens, can cause unpredictable outcome such as fire or injury to the eyes.
6. Do not cover the lens with anything other than the built-in lens shutter while the projector is on. Doing so can lead to melting of the cover and possibly burning your hands due to the heat emitted from the light output.
7. The projector is designed to operate on a power supply of 100-120 or 200-240 V 50/60 Hz AC. Ensure that your power supply fits this requirement before attempting to use your projector.
8. Handle the power cable carefully and avoid excessive bending. A damaged cord can cause electric shock or fire.
9. If the projector is not to be used for an extended period of time, disconnect the plug from the power outlet.
10. Do not touch the power plug during a thunderstorm. Doing so can cause electrical shock or fire.
11. Do not handle the power plug with wet hands.

**CAUTION**

1. Do not try to touch the ventilation outlet on the rear as it can become heated while the projector is turned on.
2. Do not use the tilt-foot for purposes other than originally intended. Misuses such as gripping the tilt-foot or hanging on the wall can cause damage to the projector.
3. When carrying the projector, heed the following:
  - \* Use the supplied soft carrying case. Before putting the projector in the soft carrying case, be sure to close the lens shutter so as not to mar the lens.
  - \* Do not handle the projector roughly.
  - \* Do not send the soft carrying case by parcel delivery service or cargo shipment. The projector inside the soft carrying case could be damaged. (However, it is possible to use it as a carrier case on board.)
4. Select "High" in the Fan mode if you continue to use the projector for consecutive days. (From the menu, select [To Advanced Menu] → [Setup 2] → [Fan Mode].)
5. Do not unplug the power cable from the wall outlet under any one of the following circumstances:
  - \* While the Hour Glass icon appears.
  - \* While the cooling fans are running. (The cooling fans continue to work for 60 seconds after the projector is turned off).

**Lamp Replacement**

- To replace the lamp, follow all instructions provided on page E-35.
- Be sure to replace the lamp when the message "**The lamp has reached the end of its usable life. Please replace the lamp.**" appears. If you continue to use the lamp after the lamp has reached the end of its usable life, the lamp bulb may shatter, and pieces of glass may be scattered in the lamp case. Do not touch them as the pieces of glass may cause injury.  
If this happens, contact your NEC dealer for lamp replacement.
- Allow a minimum of 60 seconds to elapse after turning off the projector. Then disconnect the power cable and allow 60 minutes to cool the projector before replacing the lamp.

**What's in the Box?**

Make sure your box contains everything listed. If any pieces are missing, contact your dealer. Please save the original box and packing materials if you ever need to ship your LT170 Projector.

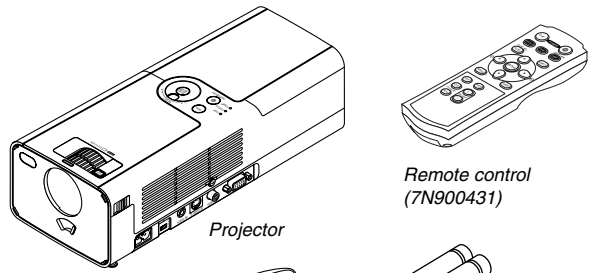

Projector

Remote control (7N900431)

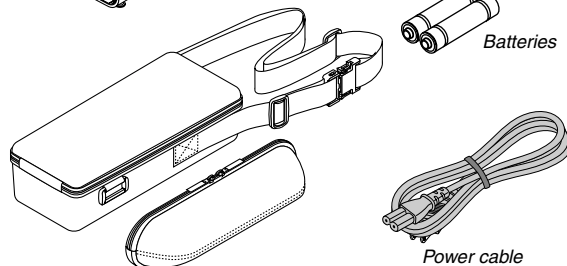

Soft carrying case and its accessory pouch (24BS7281)

Batteries

Power cable (US: 7N080206) (EU: 7N080005)

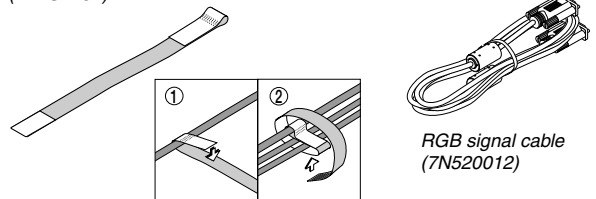

Band (24B17871)  
Use for bundling cables.

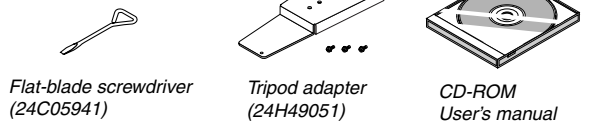

Flat-blade screwdriver (24C05941)

Tripod adapter (24H49051)

CD-ROM  
User's manual

**For North America only**  
Registration card  
Limited warranty  
**For Europe only**  
Guarantee policy

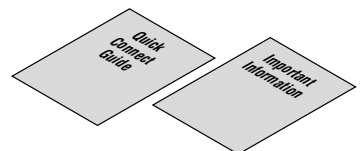

# TABLE OF CONTENTS

---

## **IMPORTANT INFORMATION ..... E-2**

Safety Cautions .....	E-2
What's in the Box? .....	E-3

## **INTRODUCTION ..... E-5**

Introduction to the Projector .....	E-5
Part Names of the Projector .....	E-6
Top Features .....	E-7
Terminal Panel Features .....	E-7
Part Names of the Remote Control .....	E-8
Battery Installation .....	E-9
Remote Control Precautions .....	E-9
Operating Range for Wireless Remote Control .....	E-9

## **INSTALLATION AND CONNECTIONS ..... E-10**

Setting Up the Screen and the Projector .....	E-10
Selecting a Location .....	E-10
Throw Distance and Screen Size .....	E-11
Making Connections .....	E-12
Connecting Your PC or Macintosh Computer .....	E-12
To connect SCART output (RGB) .....	E-13
Connecting Your DVD Player .....	E-14
Connecting Your VCR or Laser Disc Player .....	E-15
Attaching the Projector to a Tripod .....	E-16
Connecting the Supplied Power Cable .....	E-17

## **PROJECTING AN IMAGE (BASIC OPERATION) ..... E-18**

Turning on the Projector .....	E-18
Selecting a Source .....	E-19
Adjusting the Picture Size and Position .....	E-19
Correcting the Vertical Keystone Distortion .....	E-20
Optimizing RGB Picture Automatically .....	E-21
Turning Up or Down Volume .....	E-21
Turning off the Projector .....	E-22
After Use .....	E-22

## **CONVENIENT FEATURES ..... E-24**

Turning Off the Image and Sound .....	E-24
Freezing a Picture .....	E-24
Enlarging and Moving a Picture .....	E-24
Getting the Information .....	E-24
Security .....	E-24

## **USING ON-SCREEN MENU ..... E-27**

Basic Menu Operation .....	E-27
Using the Menus .....	E-27
Adjusting and Setting Items .....	E-28
List of Menu Items .....	E-29
Menu Elements .....	E-30
Menu Descriptions & Functions .....	E-31
<b>Basic Menu</b> .....	E-31
Auto Adjust Executed .....	E-31
Aspect Ratio .....	E-31
Picture Management .....	E-31
Brightness .....	E-32
Contrast .....	E-32
Sharpness .....	E-32
Color .....	E-32
Hue .....	E-32
Keystone .....	E-32

## **Advanced Manu ..... E-32**

[Image]	
Auto Adjust / Horizontal / Vertical / Clock / Phase /	
Noise Reduction / Flicker Reduction .....	E-32
[Setup 1]	
Lamp Mode / Language / Menu Color Select /	
Menu Display Time /Background / Orientation /	
Cabinet Button / Security/ Portrait .....	E-33
[Setup 2]	
Power Management / Auto Start / Fan Mode / Signal Select	E-33
[Information]	
Page 1-4 .....	E-34
[Default]	
Factory Default / Clear Lamp Hour Meter .....	E-34

## **MAINTENANCE ..... E-35**

Replacing the Lamp .....	E-35
Cleaning the Cabinet and the Lens .....	E-36

## **TROUBLESHOOTING ..... E-37**

Power Indicator (POWER) .....	E-37
Status Indicator (STATUS) .....	E-37
Lamp Indicator (LAMP) .....	E-37
Common Problems & Solutions .....	E-38

## **SPECIFICATIONS ..... E-39**

## **APPENDIX ..... E-40**

Cabinet Dimensions .....	E-40
Pin Assignments of D-Sub COMPUTER Input Connector .....	E-40
Compatible Input Signal List .....	E-41
TravelCare Guide .....	E-42

# INTRODUCTION

---

## Introduction to the Projector

This section introduces you to your new LT170 Projector and describes the features and controls.

### Congratulations on Your Purchase of The LT170 Projector

The LT170 is one of the very best projectors available today. The LT170 enables you to project precise images up to 200 inches (measured diagonally) from your PC or Macintosh computer (desktop or notebook), VCR, DVD player, document camera, or a laser disc player.

You can use the projector on a tabletop or cart, you can use the projector to project images from behind the screen, and the projector can be permanently mounted on a ceiling\*<sup>1</sup>. The remote control can be used wirelessly.

\*<sup>1</sup> Do not attempt to mount the projector on a ceiling yourself. The projector must be installed by qualified technicians in order to ensure proper operation and reduce the risk of bodily injury.

In addition, the ceiling must be strong enough to support the projector and the installation must be in accordance with any local building codes. Please consult your dealer for more information.

### Features you'll enjoy:

- Auto vertical keystone correction up to +/- 30 degrees
  - Security feature prevents the projector from being used by unauthorized individuals. Password protection prevents unauthorized individuals from changing projector settings. Cabinet Button Lock helps prevent unauthorized adjustments to the projector.
  - One touch projection angle adjustment
  - Manual lens shutter for protecting the lens
  - Supplied carrying case with pouch for accessories
  - Short focal length lens
  - Remote features one touch source change buttons
  - New Color Management system
  - Newly designed menu system with dial control
  - Multi-language on-screen menu
  - The projector can be used with a tripod
  - NEC's exclusive Advanced AccuBlend intelligent pixel blending technology - an extremely accurate image compression technology - offers image display from sources up to UXGA (1600 × 1200) resolution\*<sup>2</sup>.
  - Supports most IBM VGA, SVGA, XGA, SXGA/UXGA (with Advanced AccuBlend)\*<sup>2</sup>, Macintosh, component signal (YCbCr/YPbPr) or any other RGB signals within a horizontal frequency range of 24 to 100 kHz and a vertical frequency range of 50 to 120 Hz. This includes NTSC, PAL, PAL-N, PAL-M, PAL60, SECAM and NTSC4.43 standard video signals.
- \*<sup>2</sup> A UXGA (1600 × 1200) and SXGA image (1280 × 1024) are displayed with NEC's Advanced AccuBlend.

---

**NOTE:** Composite video standards are as follows:

**NTSC:** U.S. TV standard for video in U.S. and Canada.

**PAL:** TV standard used in Western Europe.

**PAL-N:** TV standard used in Argentine, Paraguay and Uruguay.

**PAL-M:** TV standard used in Brazil.

**PAL60:** TV standard used for NTSC playback on PAL TVs.

**SECAM:** TV standard used in France and Eastern Europe.

**NTSC4.43:** TV standard used in Middle East countries.

---

## Part Names of the Projector

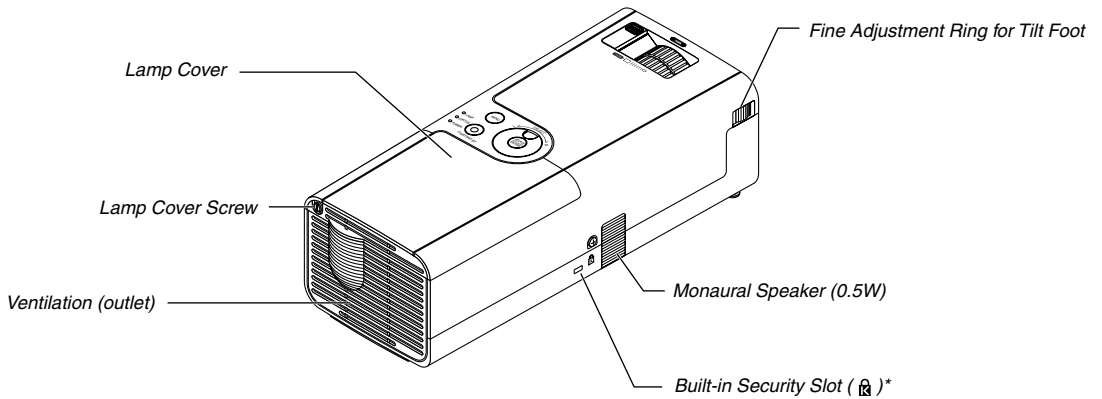
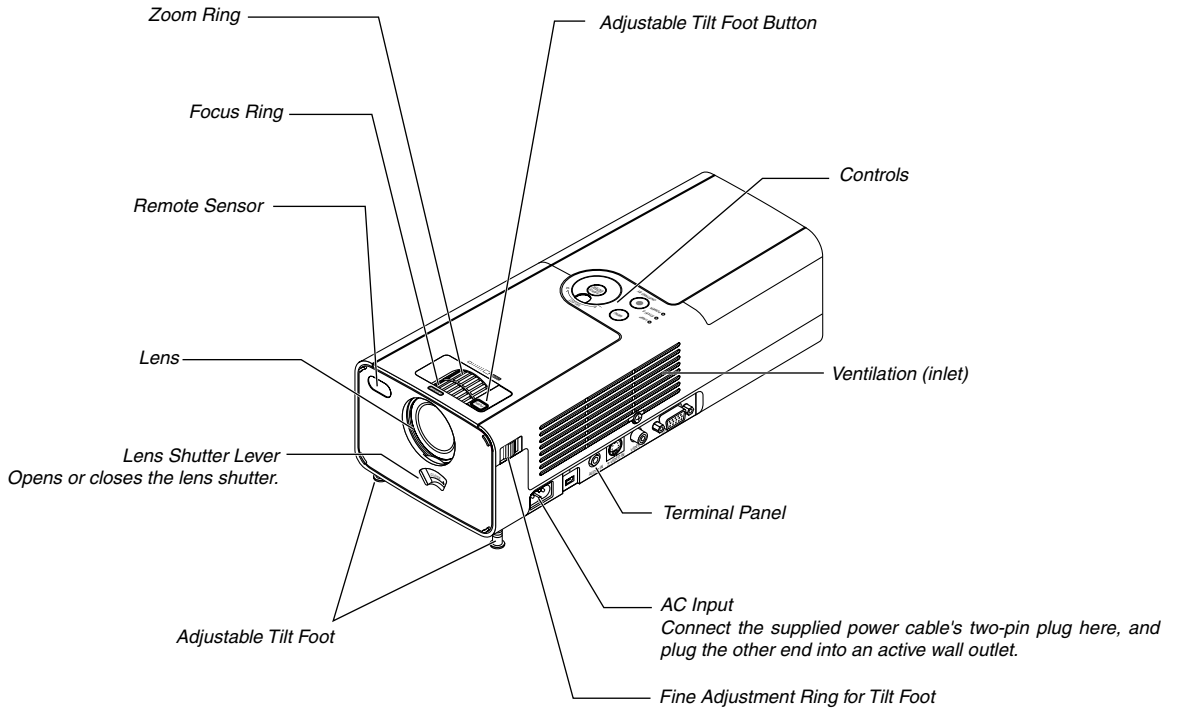

\* This security slot supports the MicroSaver® Security System. MicroSaver® is a registered trademark of Kensington Microware Inc. The logo is trademarked and owned by Kensington Microware Inc.

Top Features

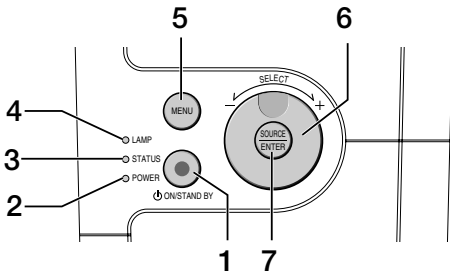

Terminal Panel Features

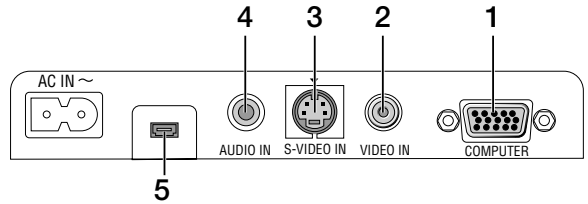

1. **POWER Button (ON / STAND BY) (⏻)**  
Use this button to turn the power on and off when the main power is supplied and the projector is in standby mode.  
To turn on the projector, press and hold this button for a minimum of two seconds. To turn off the projector, press this button twice.
2. **POWER Indicator**  
When this indicator is green, the projector is on; when this indicator is orange, it is in standby mode. See the Power Indicator section on page E-37 for more details.
3. **STATUS Indicator**  
If this light blinks red rapidly, it indicates that an error has occurred, the lamp cover is not attached properly or the projector has overheated. If this light remains orange, it indicates that you have pressed a cabinet button while the Cabinet Button is locked. See the Status Indicator section on page E-37 for more details.
4. **LAMP Indicator**  
If this light blinks red rapidly, it's warning you that the lamp has reached the end of its usable life. After this light appears, replace the lamp as soon as possible (See page E-35). If this is lit green continually, it indicates that the lamp mode is set to Eco. See the Lamp Indicator section on page E-37 for more details.
5. **MENU Button**  
Displays the menu. Press again to close the menu.
6. **SELECT +/-, Volume Dial**  
\* When the menu is displayed, rotating the dial makes menu selections. See page E-27.  
\* When the menu is not displayed, rotating the dial increases or decreases the volume. See page E-21.
7. **SOURCE/ENTER Button**  
\* When the menu is not displayed, this button works as the SOURCE button. A press of the SOURCE button displays the Source Select screen. See page E-19.  
\* When the menu is displayed, this button works as the ENTER button. A press of the ENTER button executes your menu selection and activates items selected from the menu. See page E-27.

1. **COMPUTER / Component Input Connector (Mini D-Sub 15 Pin)**  
Connect your computer or other analog RGB equipment such as IBM compatible or Macintosh computers. Use the supplied RGB cable to connect to your computer. This also serves as a component input connector that allows you to connect a component video output of component equipment such as a DVD player (optional adapter ADP-CV1 required). This connector also supports SCART output signal. See page E-13 for more details.
2. **VIDEO IN Connector (RCA)**  
Connect a VCR, DVD player, laser disc player, or document camera here to project video.
3. **S-VIDEO IN Connector (Mini DIN 4 Pin)**  
Here is where you connect the S-Video input from an external source like a VCR.  
***NOTE:** S-Video provides more vivid color and higher resolution than the traditional composite video format.*
4. **AUDIO IN Mini Jack (Stereo Mini)**  
This is where you connect the audio output from your computer or DVD player. A commercially available audio cable is required.
5. **Maintenance Terminal**  
For service use only.

**Part Names of the Remote Control**

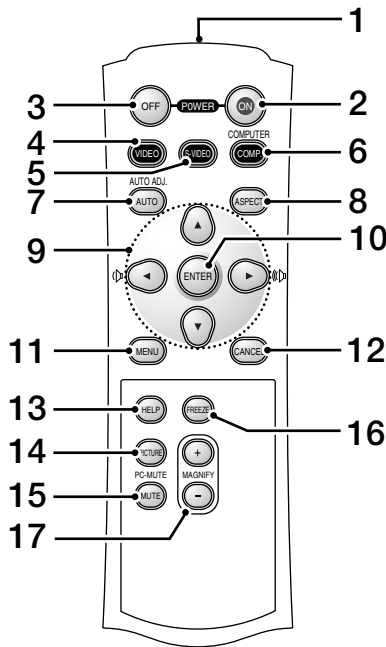

- 1. Infrared Transmitter  
Direct the remote control toward the remote sensor on the projector cabinet.
- 2. POWER ON Button  
When the main power is supplied, you can use this button to turn your projector on.  
**NOTE:** To turn on the projector, press and hold the POWER ON button for a minimum of two seconds.
- 3. POWER OFF Button  
You can use this button to turn your projector off.  
**NOTE:** To turn off the projector, press the POWER OFF button twice.
- 4. VIDEO Button  
Press this button to select a video source from a VCR, DVD player, laser disc player or document camera.
- 5. S-VIDEO Button  
Press this button to select an S-Video source from a VCR.
- 6. COMPUTER Button  
Press this button to select Computer input.
- 7. AUTO ADJ. Button  
Use this button to adjust an RGB source for an optimal picture. See page E-21.
- 8. ASPECT Button  
Press this button to display the Aspect Ratio select screen. See page E-31.
- 9. ▲▼◀▶ Button  
▲▼ : Use these buttons to select the menu of the item you wish to adjust.  
◀▶ : Use these buttons to change the level of a selected menu item. When no menus appear, these buttons work as a volume control.  
When an image is magnified, the ▲▼◀▶ button moves the image.
- 10. ENTER Button  
Executes your menu selection and activates items selected from the menu.
- 11. MENU Button  
Displays the menu for various settings and adjustments. Press again to close the menu.
- 12. CANCEL Button  
Pressing this button will return to the previous menu. While you are in the Basic menu, pressing this button will close the menu.
- 13. HELP Button  
Provides the projector information.
- 14. PICTURE Button  
Press this button to display the Picture adjustment screen such as Brightness, Contrast, Sharpness, Color and Hue. See page E-32.
- 15. PIC-MUTE Button  
This button turns off the image and sound for a short period of time. Press again to restore the image and sound.
- 16. FREEZE Button  
This button will freeze a picture. Press again to resume motion.
- 17. MAGNIFY (+)(-) Button  
Use this button to adjust the image size up to 400%. The image is magnified about the center of the screen. See page E-24.



### Battery Installation

1. Press firmly and slide the battery cover off.

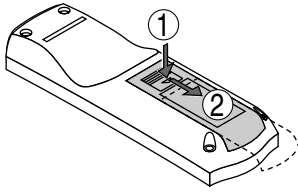

2. Remove both old batteries and install new ones (AAA). Ensure that you have the batteries' polarity (+/-) aligned correctly.

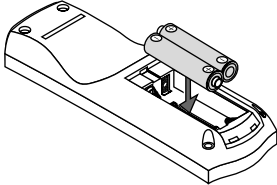

3. Slip the cover back over the batteries until it snaps into place. Do not mix different types of batteries or new and old batteries.

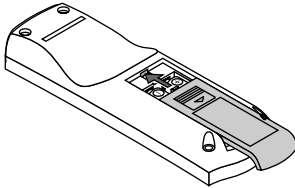

### Remote Control Precautions

- Handle the remote control carefully.
- If the remote control gets wet, wipe it dry immediately.
- Avoid excessive heat and humidity.
- If you will not be using the remote control for a long time, remove the batteries.
- Do not place the batteries upside down.
- Do not use new and old batteries together, or use different types of batteries together

### Operating Range for Wireless Remote Control

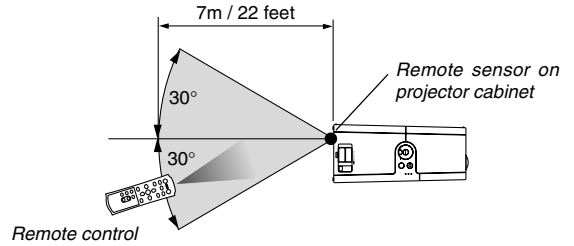

Actual operating range may differ from the above drawing.

- The infrared signal operates by line-of-sight up to a distance of about 22 feet/7 m and within a 60-degree angle of the remote sensor on the projector cabinet.
- The projector will not respond if there are objects between the remote control and the sensor, or if strong light falls on the sensor. Weak batteries will also prevent the remote control from properly operating the projector.

# INSTALLATION AND CONNECTIONS

This section describes how to set up your projector and how to connect video and audio sources.

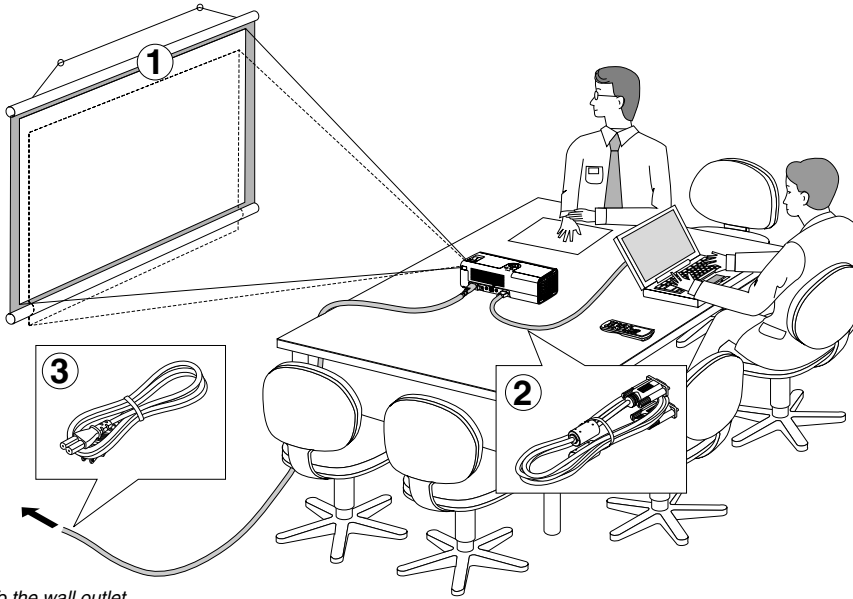

Your projector is simple to set up and use. But before you get started, you must first:

- ① Set up a screen and the projector.
- ② Connect your computer or video equipment to the projector. See pages E-12 to 15.
- ③ Connect the supplied power cable. See page E-17.

**NOTE:** Ensure that the power cable and any other cables are disconnected before moving the projector. When moving the projector or when it is not in use, close the lens shutter.

To the wall outlet.

## Setting Up the Screen and the Projector

### Selecting a Location

The further your projector is from the screen or wall, the larger the image. The minimum size the image can be is approximately 30" (0.76 m) measured diagonally when the projector is roughly 44.5 inches (1.1 m) from the wall or screen. The largest the image can be is 200" (5.0 m) when the projector is about 305.5 inches (7.8 m) from the wall or screen. Use the drawing below as a guide.

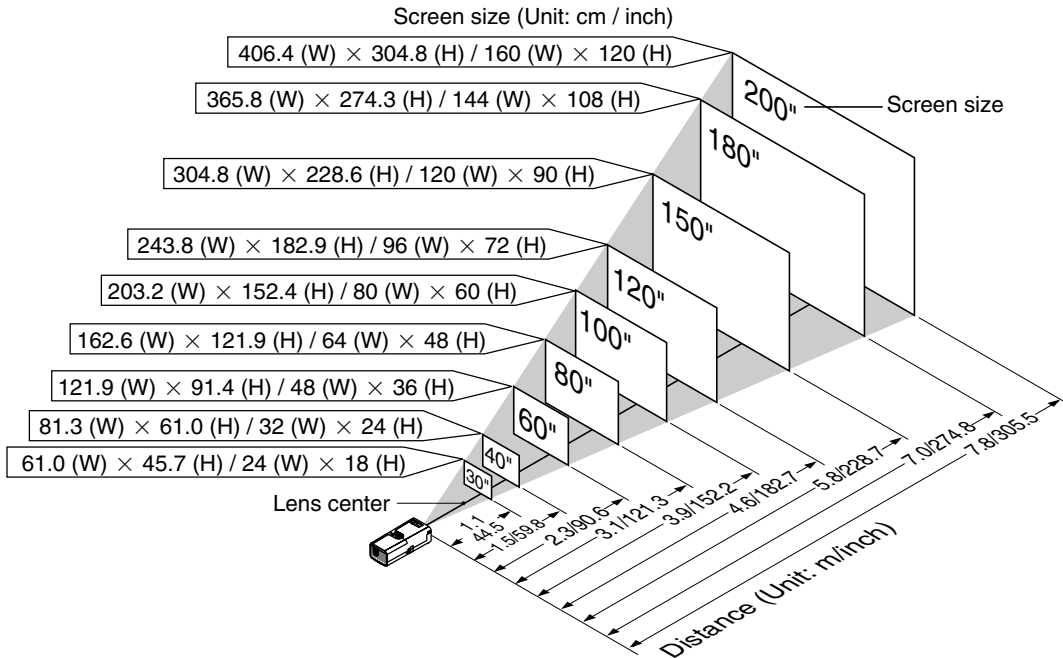

**CAUTION:** To avoid premature lamp failure, do not tilt the front of the projector up or down by more than 10° from level.

**Throw Distance and Screen Size**

The following shows the proper relative positions of the projector and screen. Refer to the table to determine the position of installation.

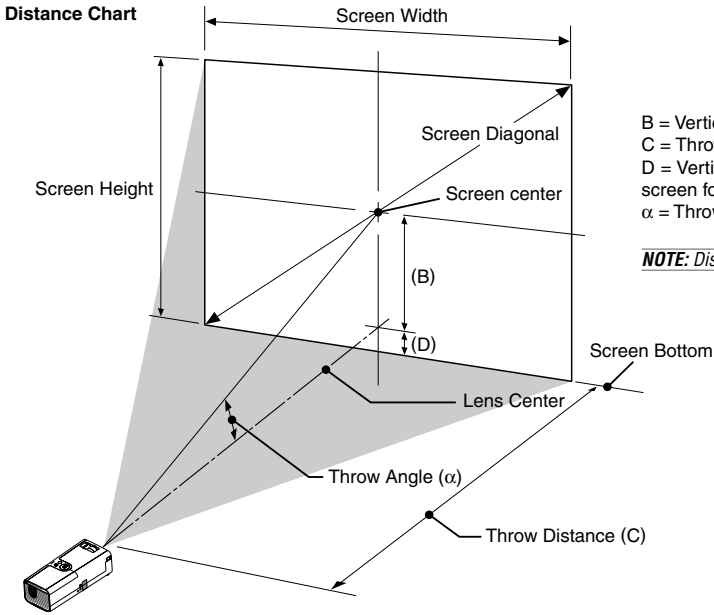

B = Vertical distance between lens center and screen center  
 C = Throw distance  
 D = Vertical distance between lens center and top of screen (bottom of screen for desktop)  
 α = Throw angle

**NOTE:** Distances may vary +/-5%.

Screen Size			B inch	C Wide - Tele inch	D inch	α Wide - Tele degree
Diagonal inch	Width inch	Height inch				
30	24	18	7	42 - 47	2	9.7 - 8.7
40	32	24	10	57 - 63	2	9.5 - 8.7
60	48	36	14	86 - 95	4	9.5 - 8.6
67	54	40	16	96 - 106	4	9.5 - 8.6
72	58	43	17	104 - 114	4	9.4 - 8.6
80	64	48	19	115 - 127	5	9.4 - 8.6
84	67	50	20	121 - 133	5	9.4 - 8.6
90	72	54	22	130 - 143	5	9.4 - 8.6
100	80	60	24	145 - 159	6	9.4 - 8.6
120	96	72	29	174 - 191	7	9.4 - 8.6
150	120	90	36	218 - 240	9	9.4 - 8.5
180	144	108	43	262 - 288	11	9.4 - 8.5
200	160	120	48	291 - 320	12	9.4 - 8.5

Screen Size			B mm	C Wide - Tele mm	D mm	α Wide - Tele degree
Diagonal mm	Width mm	Height mm				
762	610	457	183	1070 - 1190	46	9.7 - 8.7
1016	813	610	244	1450 - 1590	61	9.5 - 8.7
1524	1219	914	366	2190 - 2410	92	9.5 - 8.6
1702	1361	1021	408	2450 - 2700	102	9.5 - 8.6
1829	1463	1097	439	2640 - 2900	110	9.4 - 8.6
2032	1626	1219	487	2930 - 3230	122	9.4 - 8.6
2134	1707	1280	512	3080 - 3390	128	9.4 - 8.6
2286	1829	1372	548	3300 - 3640	137	9.4 - 8.6
2540	2032	1524	609	3680 - 4050	153	9.4 - 8.6
3048	2438	1829	731	4420 - 4860	183	9.4 - 8.6
3810	3048	2286	914	5530 - 6090	229	9.4 - 8.5
4572	3658	2743	1097	6650 - 7310	275	9.4 - 8.5
5080	4064	3048	1219	7390 - 8130	305	9.4 - 8.5

**WARNING**

- \* **Installing your projector on the ceiling must be done by a qualified technician. Contact your NEC dealer for more information.**
- \* **Do not attempt to install the projector yourself.**
- Only use your projector on a solid, level surface. If the projector falls to the ground, you can be injured and the projector severely damaged.
- Do not use the projector where temperatures vary greatly. The projector must be used at temperatures between 41°F (5°C) and 95°F (35°C).
- Do not expose the projector to moisture, dust, or smoke. This will harm the screen image.
- Ensure that you have adequate ventilation around your projector so heat can dissipate. Do not cover the vents on the side or the front of the projector.

**Reflecting the Image**

Using a mirror to reflect your projector's image enables you to enjoy a much larger image. Contact your NEC dealer if you need a mirror. If you're using a mirror and your image is inverted, use the MENU button and SELECT dial on your projector cabinet or the MENU and the ▲▼◀▶ buttons on your remote control to correct the orientation. (See page E-33.)

## Making Connections

**NOTE:** When using with a notebook PC, be sure to connect between the projector and the notebook PC before turning on the power to the notebook PC. In most cases signal cannot be output from RGB output unless the notebook PC is turned on after connecting with the projector.

\* If the screen goes blank while using your remote control, it may be the result of the computer's screen-saver or power management software.

\* If you accidentally hit the POWER button on the remote control, wait 60 seconds and then press the POWER button again to resume.

### Connecting Your PC or Macintosh Computer

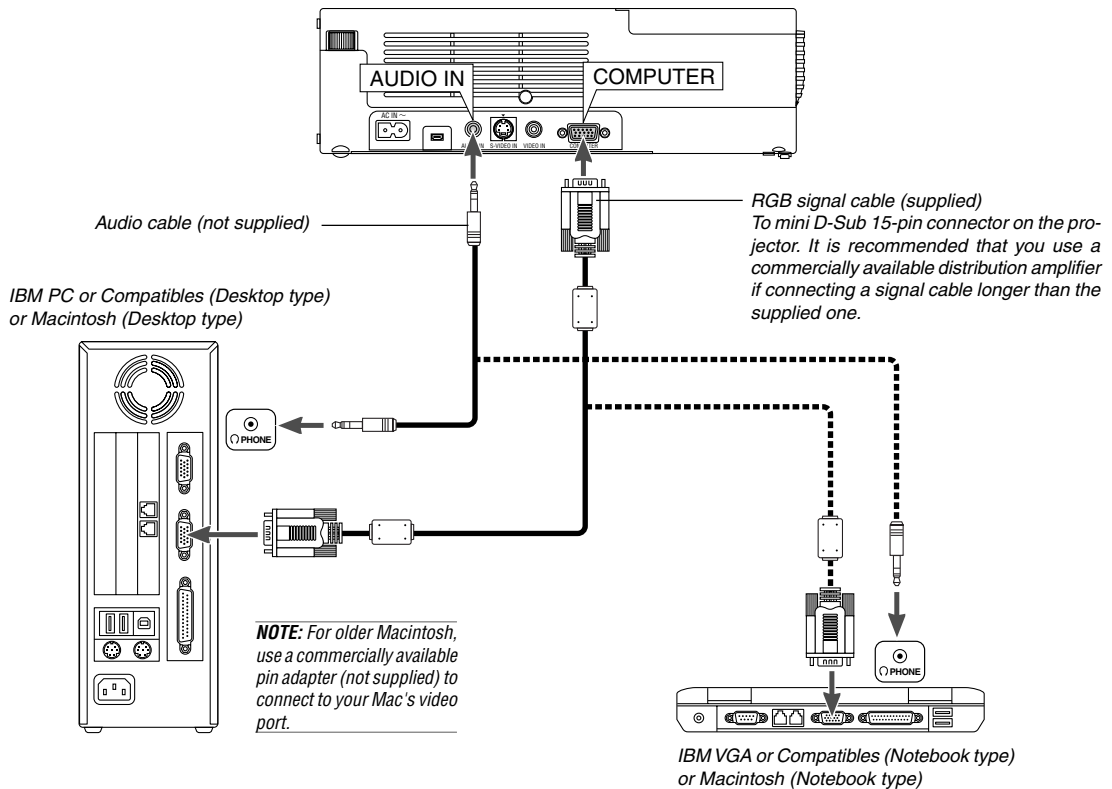

Connecting your PC or Macintosh computer to your projector will enable you to project your computer's screen image for an impressive presentation. To connect to a PC or Macintosh, simply:

1. Turn off the power to your projector and computer.
2. Use the supplied signal cable to connect your PC or Macintosh to the projector.
3. Turn on the projector and the computer.
4. If the projector goes blank after a period of inactivity, it may be caused by a screen saver installed on the computer you've connected to the projector.

## INSTALLATION AND CONNECTIONS

### To connect SCART output (RGB)

Before connections: An exclusive SCART adapter (ADP-SC1) and a commercially available SCART cable are required for this connection.

**NOTE:** Audio signal is not available for this connection.

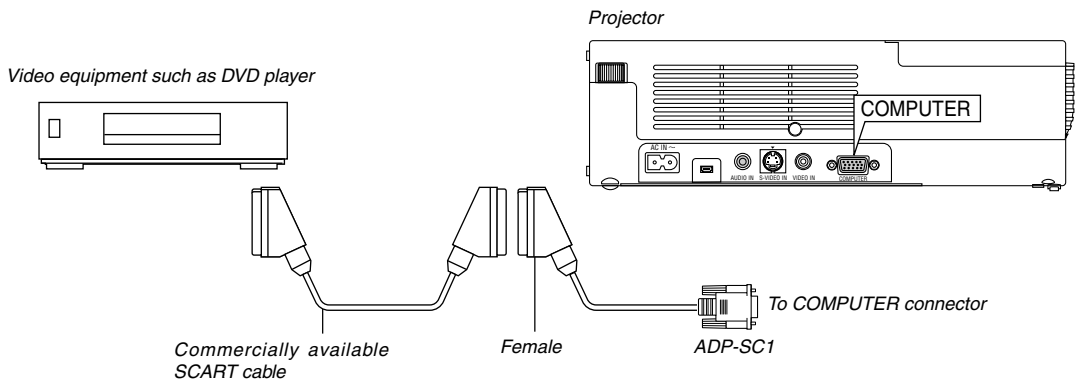

1. Turn off the power to the projector and your video equipment.
2. Use the NEC ADP-SC1 SCART adapter and a commercially available SCART cable to connect the COMPUTER input of your projector and a SCART output (RGB) of your video equipment.
3. Turn on the power to the projector and your video equipment.
4. Use the COMPUTER button on the remote control to select the COMPUTER input.
5. Press the MENU button on the remote control to display the menu.
6. From the menu, select [To Advanced Menu] → [Setup 2] → [Signal Select Computer] → [Scart].

SCART is a standard European audio-visual connector for TVs, VCRs and DVD players. It is also referred to as Euro-connector.

**NOTE:** The ADP-SC1 SCART adapter is obtainable from your NEC dealer in Europe. Contact your NEC dealer in Europe for more information.

### Using the projector in portrait mode

When connecting with a Tablet PC, you can display an image in portrait mode with the projector on its side.

- Place the projector on a location such as a table with the terminal panel side up.
- Be sure to place the projector on a flat level surface.
- Auto Keystone correction feature is not available.
- The on-screen menu will not be rotated.
- If the image is displayed upside down, select [Advanced menu] → [Setup 1] → [Portrait] → [0°] or [180°] for display orientation of your PC. See also page E-33 for Portrait.

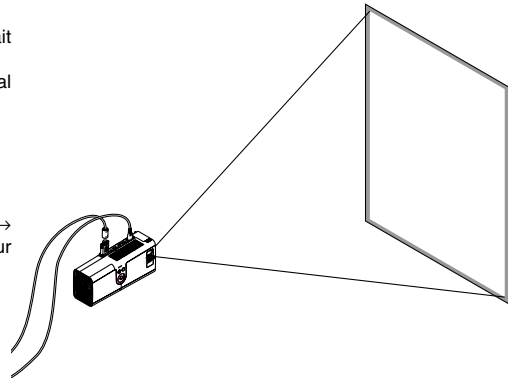

The projected image is displayed at a lower level than the normal position. Adjust the projection angle and position for the correct position of the projected image on screen.

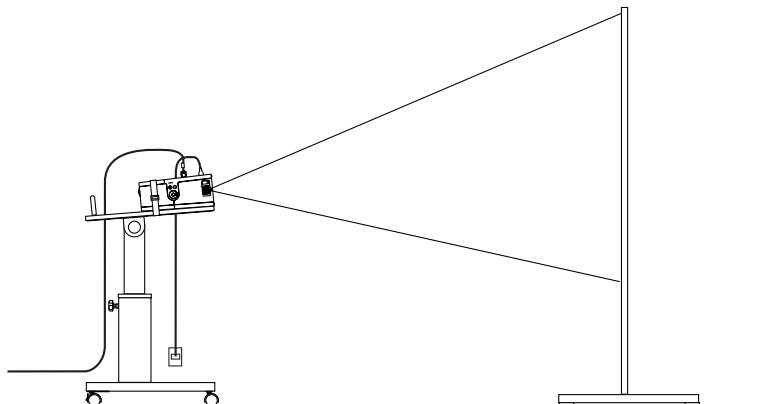

Connecting Your DVD Player

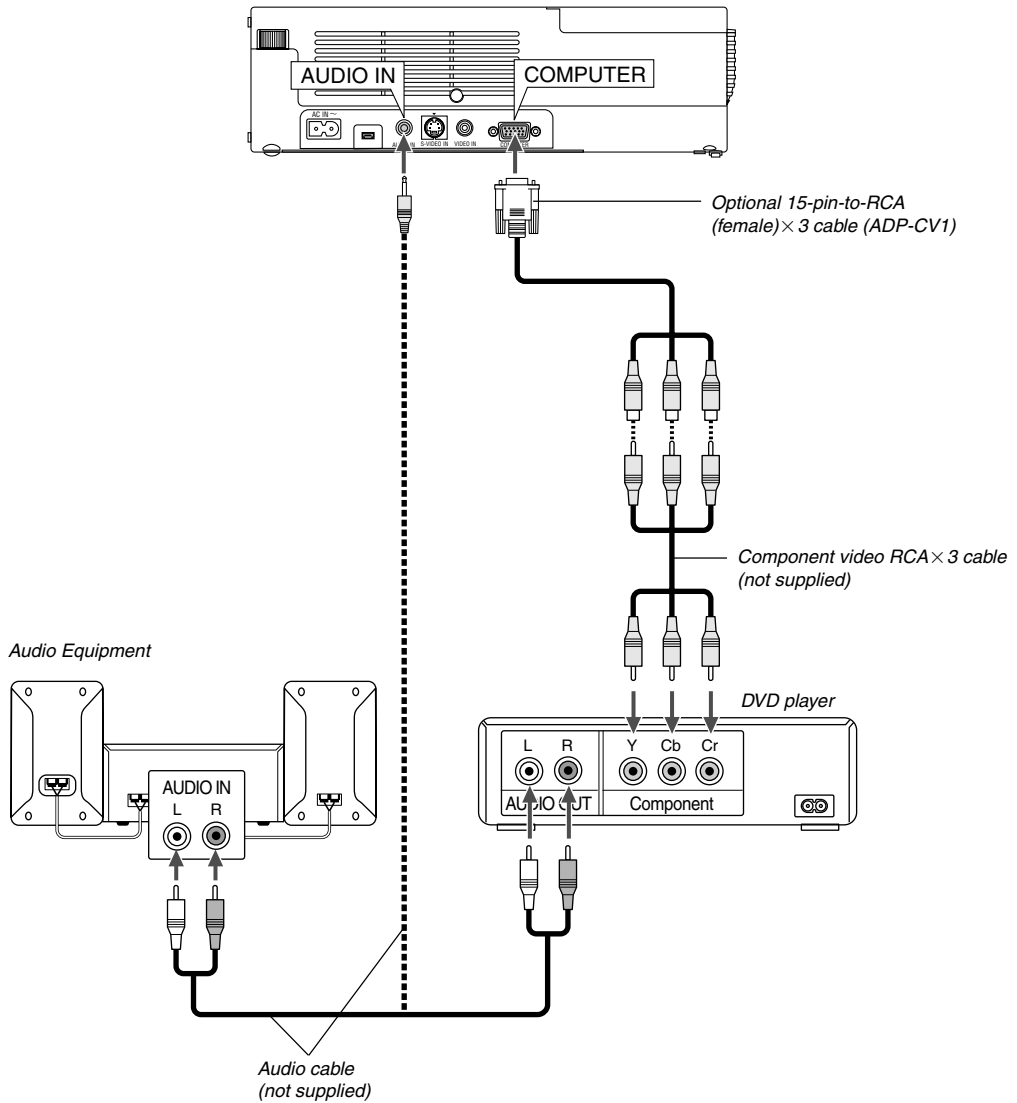

You can connect your projector to a DVD player with component output or Video output. To do so, simply:

1. Turn off the power to your projector and DVD player.
2. If your DVD player has the component video (Y,Cb,Cr) output, use a commercially available component video cable (RCA×3) and the optional 15-pin-to-RCA (female)×3 cable to connect your DVD player to the COMPUTER input connector on the projector.  
 For a DVD player without component video (Y,Cb,Cr) output, use common RCA cables (not provided) to connect a composite VIDEO output of the DVD player to the Video Input of the projector.
3. Turn on the projector and DVD player.

**NOTE:** Refer to your DVD player's owner's manual for more information about your DVD player's video output requirements.

Connecting Your VCR or Laser Disc Player

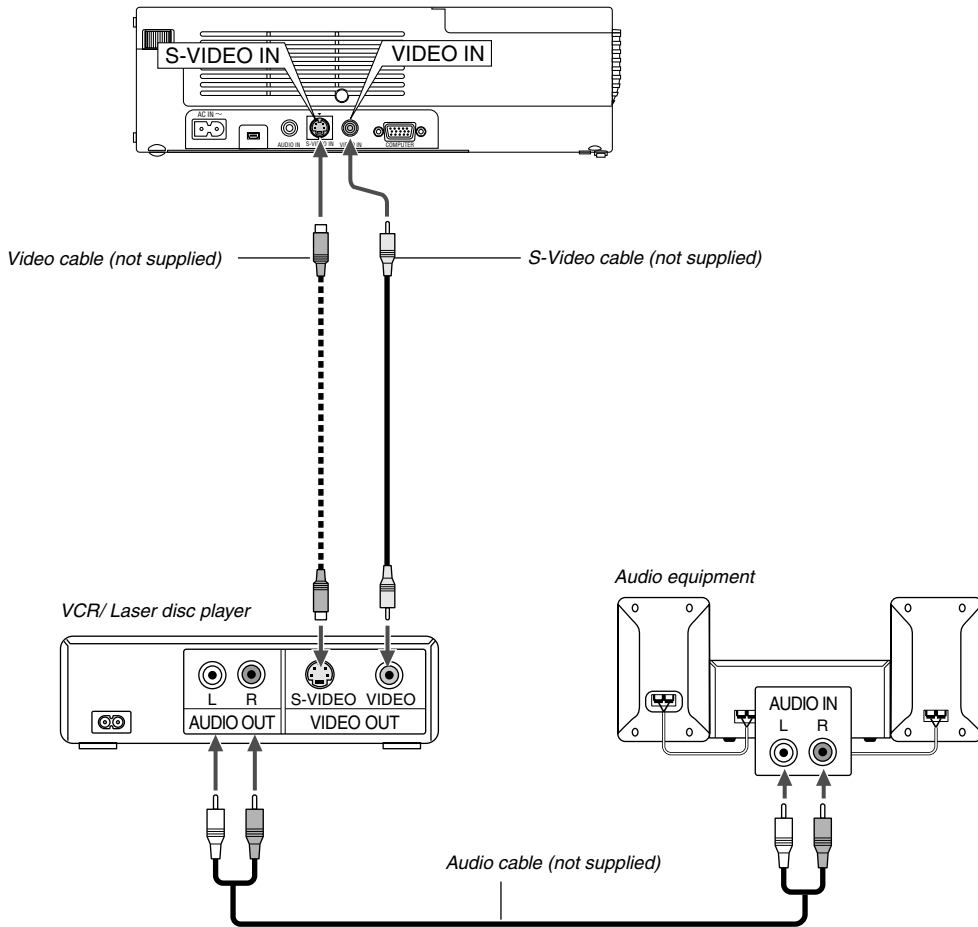

Use common RCA cables (not provided) to connect your VCR, laser disc player or document camera to your projector. To make these connections, simply:

1. Turn off the power to the projector and VCR, laser disc player or document camera.
2. Connect one end of your RCA cable to the video output connector on the back of your VCR or laser disc player, connect the other end to the Video input on your projector. Use an audio cable (not supplied) to connect the audio from your VCR or laser disc player to your audio equipment (if your VCR or laser disc player has this capability). Be careful to keep your right and left channel connections correct for stereo sound.
3. Turn on the projector and the VCR or laser disc player.

**NOTE:** Refer to your VCR or laser disc player owner's manual for more information about your equipment's video output requirements.

## Attaching the Projector to a Tripod

The projector can be used with a camera tripod. To attach the projector to a tripod, use the supplied tripod adapter.

### ⚠ CAUTION

Care should be taken in handling a tripod. Using the tripod on an unstable surface may result in the tripod falling over or the projector falling which may result in damage to the projector and possible personal injury. Read the instructions supplied with your tripod for handling and cautions.

- Use a tripod that can fully support the weight of the projector (approximately 5.5 lb/2.5 kg including attachment).
- Place the tripod with its feet fully open and weight evenly distributed for stability.
- When using a tripod with a geared elevator, do not extend the geared elevator.
- When displaying an image in portrait mode (with the projector on its side) (page E-13), be sure the tripod is balanced for stability. Failure to do so may result in the tripod falling over.

Preparation:

1. Disconnect all the cables.
2. A flat-blade screwdriver is required for attaching the supplied three (3) screws. Use the supplied flat-blade screwdriver.

### 1. Turn the projector upside down.

Place the projector on a soft cloth so as not to scratch the cabinet surface.

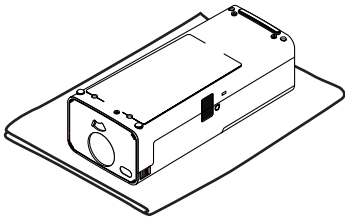

### 2. Attach the supplied tripod adapter to the bottom of the projector.

Secure the tripod adapter to the projector with the supplied (3) screws.

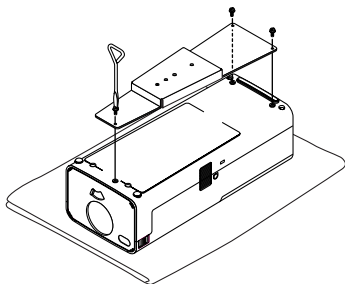

### 3. Attach the projector to the tripod.

Open the tripod to a fully extended position for greatest stability.

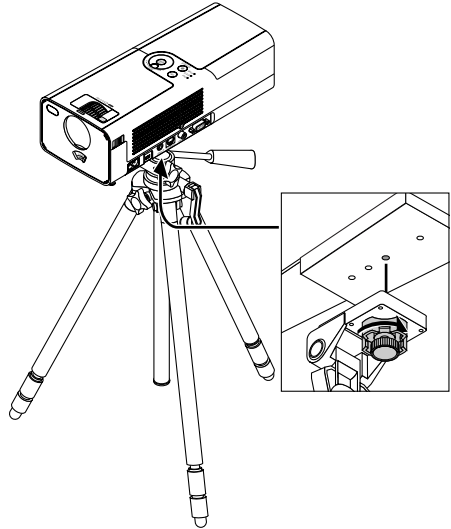

### 4. Connect all the cables.



### Connecting the Supplied Power Cable

Connect the supplied power cable to the projector.

First connect the supplied power cable's two-pin plug to the AC IN of the projector, and then connect the other plug of the supplied power cable in the wall outlet.

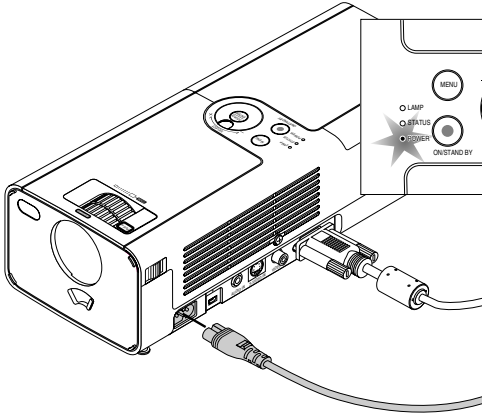

The projector will go into its standby mode and the power indicator will glow orange.

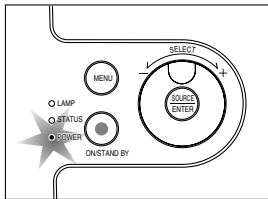
**CAUTION:**

Do not unplug the power cable from the wall outlet under any one of the following circumstances.

Doing so can cause damage to the projector:

- \* While the Hour Glass icon appears.
- \* While the cooling fans are running. (The cooling fans continue to work for 60 seconds after the projector is turned off).

# PROJECTING AN IMAGE (BASIC OPERATION)

This section describes how to turn on the projector and to project a picture onto the screen.

## Turning on the Projector

Before you turn on your projector, ensure that the computer or video source is turned on and that your lens shutter is open.

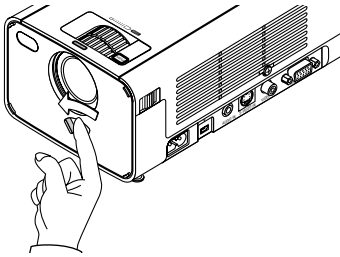

Only after you press the POWER (ON/STAND BY) button on the projector cabinet or POWER ON button on the remote control for a minimum of 2 seconds will the power indicator turn to green and the projector become ready to use.

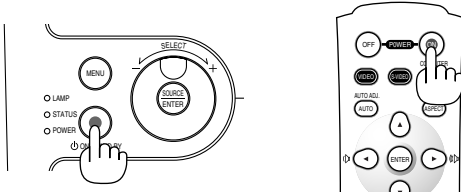

**NOTE:** To turn the projector on by plugging in the power cable, use the menu and enable the "Auto Start" feature. (See page E-33)

### Note on Startup screen (Menu Language Select screen)

When you first turn on the projector, you will get the Startup screen. This screen gives you the opportunity to select one of the 7 menu languages.

**NOTE:** If you want, you can select one of the 20 menu language later. See "Language" on page E-33.

To select a menu language, follow these steps:

1. Use the dial to select one of the 7 languages for the menu.  
When using the remote control, keep pressing the ▼ button several times until your language is highlighted.

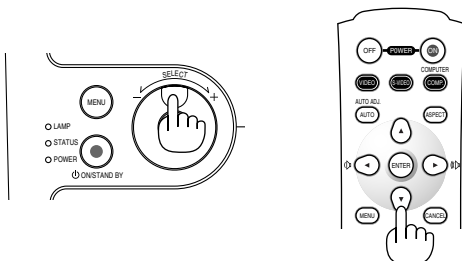

Menu Language Select	
Please select a menu language.	English
Wählen Sie bitte die Menü Sprache aus.	Deutsch
S'il vous plaît choisir la langue de menu.	Français
Per favore di scegliere la lingua di menu.	Italiano
Escoja por favor el idioma de menú.	Español
Välj menyn språken.	Svenska
メニュー言語を選択してください。	日本語
Select "UP", "DOWN" & "ENTER"	

2. Press the ENTER button to execute the selection.

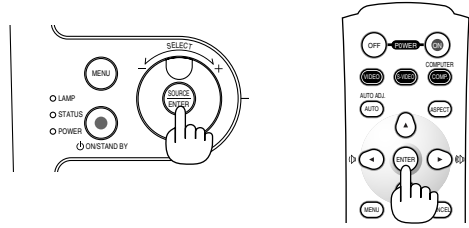

After this has been done, you can proceed to the menu operation.

**NOTE:** Immediately after turning on the projector, screen flicker may occur. This is not a malfunction. Wait 3 to 5 minutes until the lamp lighting is stabilized.

When the Lamp mode is set to Eco, the Lamp indicator will light green.

If one of the following things happens, the projector will not turn on.

- \* If the internal temperature of the projector is too high, the projector detects abnormal high temperature. In this condition the projector will not turn on to protect the internal system. If this happens, wait for the projector's internal components to cool down.
- \* When the lamp reaches its end of usable life, the projector will not turn on. If this happens, replace the lamp.
- \* If the lamp fails to light, and if the STATUS indicator flashes on and off in a cycle of six times, wait a full minute and then turn on the power.

If one of the following things happen, the projector will mute a picture. If it continues muting for 15 minutes, the projector will go into standby mode.

- \* Turning on the power with the lens shutter closed.
- \* Closing the lens shutter during operation.
- \* Directing the lens downward by more than 60° from level during operation.
- \* Turning on the power with the lens directed down by more than 60° from level.

## Selecting a Source

### Selecting the computer or video source

Using the cabinet buttons



Press and quickly release the SOURCE button on the projector cabinet to display the Source list. Each time the SOURCE button is pressed, each source name will be highlighted in sequence. Highlighting a source name will display an hour glass icon in one second. After that the input signal will be selected.

Using the Remote Control



Press any one of the COMPUTER, VIDEO or S-VIDEO buttons.

**NOTE:** If no input signal is available, the projector will display a blue background (factory preset).

### Adjusting the Picture Size and Position

Place your projector on a flat level surface and ensure that the projector is square to the screen.

Lift the front edge of the projector to center the image vertically.

\* If the projected image does not appear square to the screen then use the Keystone feature for proper adjustment. See page E-20.

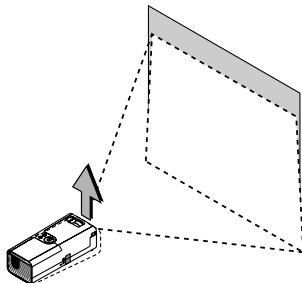

Move the projector left to center the image horizontally on the screen.

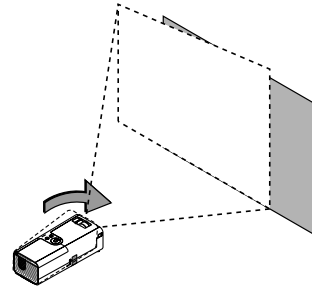

### Adjust the Tilt Foot

1. Lift the front part of the projector.

Push and hold the **PUSH** symbol of the Adjustable Tilt Foot button on the front top of the projector to extend the adjustable tilt feet up to a maximum height.

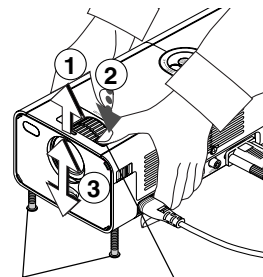

Adjustable Tilt Foot      Adjustable Tilt Foot Button

2. Lower the front of the projector to the desired height (max. 40mm/1.6") and release the Adjustable Tilt Foot Button to lock the Adjustable tilt foot. There is approximately 10 degrees of up and down adjustment for the front of the projector.

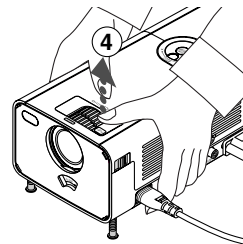

**NOTE:** You can rotate the Fine Adjustment rings of both tilt feet on the left and right sides of the cabinet front for fine adjustment of the tilt feet.

### CAUTION:

Do not use the tilt-foot for purposes other than originally intended. Misuses such as gripping the tilt-foot or hanging on the wall can cause damage to the projector.

**Zoom**

Use the ZOOM ring to finely adjust the image size on the screen.

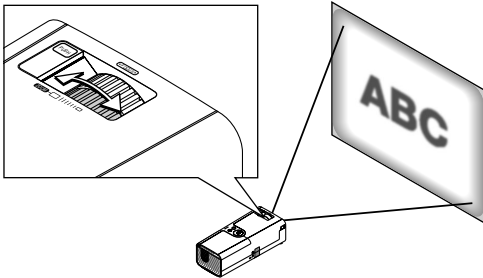

You can use the ZOOM ring to enlarge or reduce an image size.

**Focus**

Use the FOCUS ring to obtain the best focus.

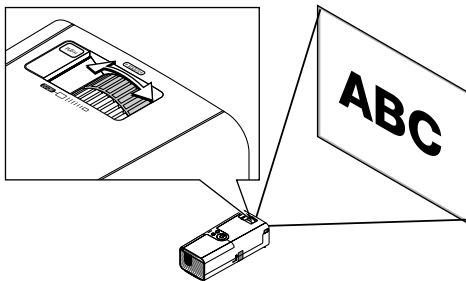

**Correcting the Vertical Keystone Distortion**

**Auto Keystone Correction**

The Auto Keystone correction feature will correct the vertical distortion of a projected image on the screen. No special operation required. Just put the projector on a flat surface.

Note that the vertical keystone angle can be corrected between 30 degrees upward and 30 degrees downward of projector tilt from level.



**NOTE:** Keystone correction angle could be less than 30 degrees for some signals that have a high resolution or frequency such as UXGA.

**Manual Keystone Correction**

You can also correct the vertical keystone distortion manually.

To do so:

1. Press the MENU button.

The menu will be displayed.

2. Select the Keystone function. Rotate the SELECT +/- dial to select "Keystone" and then press the ENTER button.

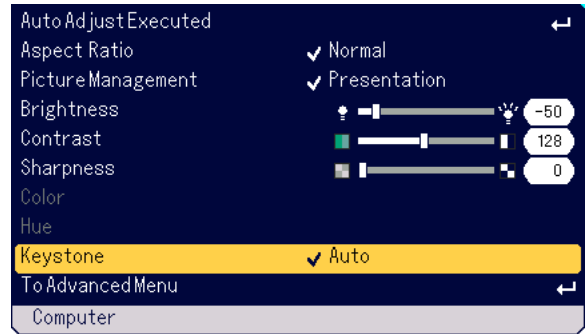

The three options will be displayed.

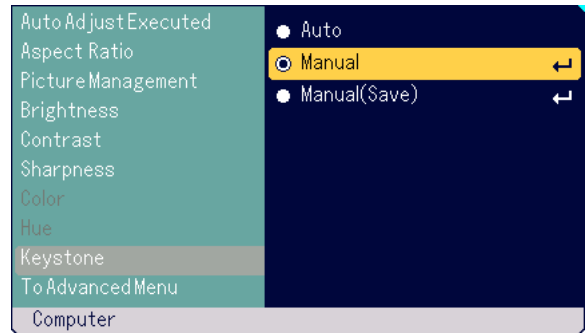

3. Rotate the SELECT +/- dial to select "Manual" and then press the ENTER button.

The Keystone adjustment bar will be displayed.



4. Correct the vertical distortion.

Rotate the SELECT +/- dial to correct the vertical keystone distortion.

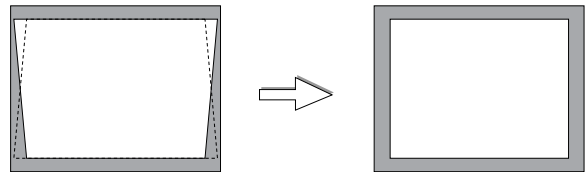

5. Press the ENTER button to take effect.

6. Press the MENU button to close the menu.

**NOTE:**

- You can save the changes by selecting "Manual (Save)" when you turn off the projector.
- When you use the projector in portrait mode, vertical keystone distortion looks horizontal keystone distortion.

## Optimizing RGB Picture Automatically

### Adjusting the Image Using Auto Adjust

Optimizing RGB image automatically.

#### Using the cabinet buttons

1. Press the MENU button .

The Basic menu will be displayed. Make sure that "Auto Adjust Executed" is selected.

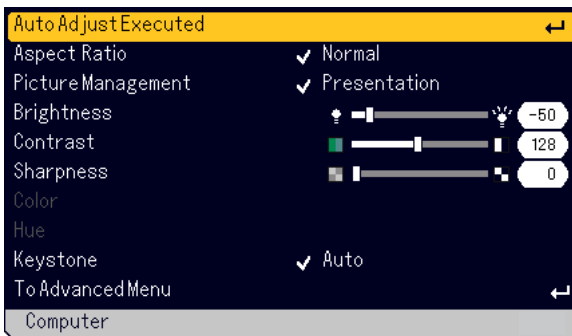
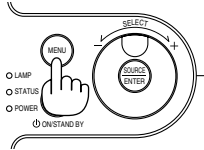

2. Press the ENTER button to optimize an RGB image automatically. The Hour Glass icon will appear. It takes some seconds to optimize an RGB image.

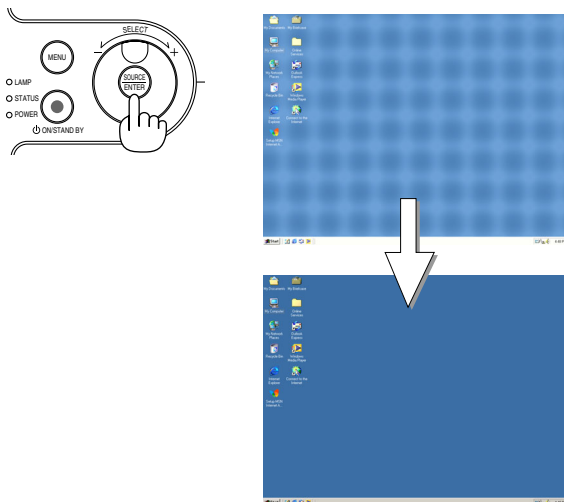

### Using the remote control

Press the AUTO ADJ. button

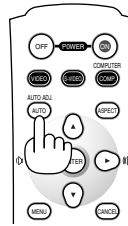

The Hour Glass icon will appear. It takes some seconds to optimize an RGB image.

This function adjusts the clock frequencies that eliminate the horizontal banding in the image. This function also adjusts the clock phase to reduce video noise, dot interference or cross talk. (This is evident when part of your image appears to be shimmering.)

This adjustment may be necessary when you connect your computer for the first time.

#### NOTE:

- Some signals may not be displayed correctly or take time.
- The Auto Adjust function does not work for component and video signal.
- If the Auto Adjust operation cannot optimize the RGB signal, try to adjust Clock and Phase manually. See page E-32.

## Turning Up or Down Volume

Sound level from the speaker on the projector can be adjusted when the menu is not displayed.

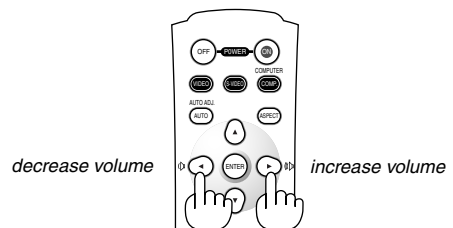
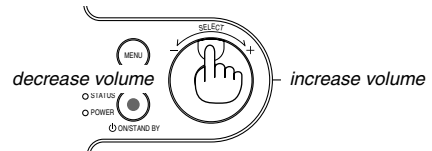

## Turning off the Projector

### To turn off the projector:

First, press the POWER (ON/STAND BY) button on the projector cabinet or the POWER OFF button on the remote control. The "Power Off / Are you sure?" message will appear.

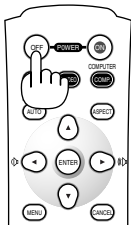
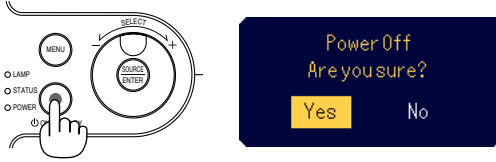

Secondly, press the ENTER button or press the POWER (ON/STAND BY) or the POWER OFF button again.

The power indicator will glow orange. After the projector turns off, the cooling fans keep operating for 60 seconds (Cooling-off time). Lastly unplug the power cable. The power indicator will go out.

### CAUTION

Do not unplug the power cable from the wall outlet under any one of the following circumstances. Doing so can cause damage to the projector:

- While the Hour Glass icon appears.
- While the cooling fans are running. (The cooling fans continue to work for 60 seconds after the projector is turned off).

## After Use

**Preparation:** Make sure that the projector is not turned on.

1. Unplug the power cable.
2. Disconnect any other cables.
3. Retract adjustable tilt feet if extended.

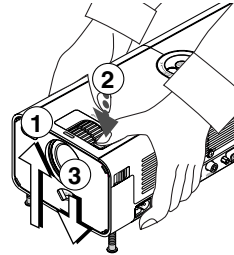

- ① Lift the front part of the projector.
  - ② Push and hold the  symbol of the Adjustable Tilt Foot button to extend the adjustable tilt feet up to a maximum height.
  - ③ Lower the front of the projector while pressing and holding the Adjustable Tilt Foot button until retracting the Adjustable Tilt Foot down to a minimum height.
4. Use the Lens Shutter lever to close the lens shutter.

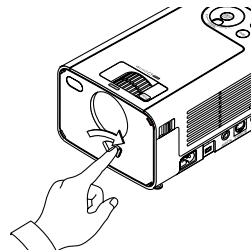

5. Put the projector and its accessories in the soft carrying case. See "Using the Soft Carrying Case" on the following page.

**Using the Soft Carrying Case**

The accessory pouch can be attached to the soft carrying case as shown in the drawing.

- \* **Placing the projector and its accessories in the soft carrying case**

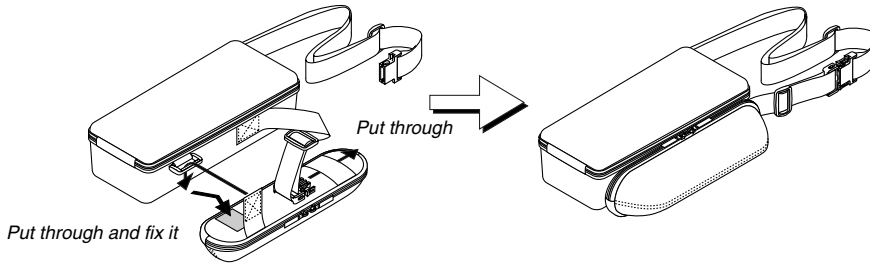

Work should be done on a flat level surface to prevent overturning.

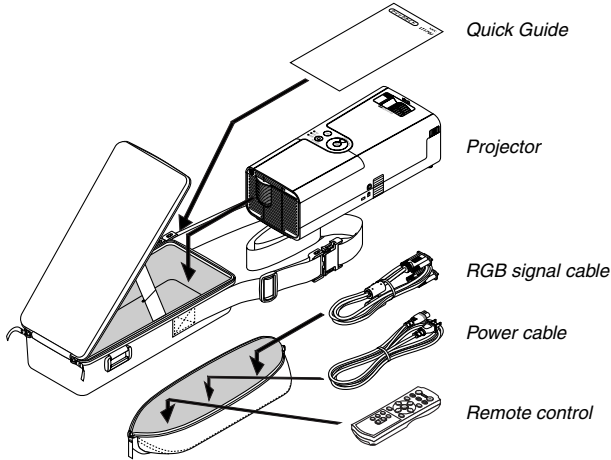

- \* **The length of the belt is adjustable.**

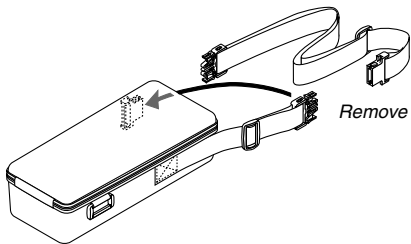

# CONVENIENT FEATURES

## Turning Off the Image and Sound

Press the PIC-MUTE button to turn off the image and sound for a short period of time. Press again to restore the image and sound.

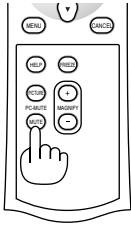

## Getting the Information

You get the information about the signal and projector settings.

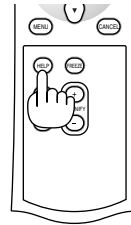

Display Information

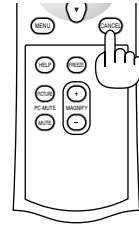

Exit Information

## Freezing a Picture

Press the FREEZE button to freeze a picture. Press again to resume motion.

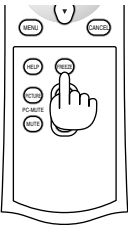

## Security

A keyword can be set for your projector to avoid operation by an unauthorized user using the Menu. When a keyword is set, turning on the projector will display the Keyword input screen. Unless the correct keyword is entered, the projector cannot project an image.

### To set a keyword:

1. Press the MENU button.  
The Basic menu will be displayed.

## Enlarging and Moving a Picture

You can enlarge the picture up to 400 percent.  
To do so:

1. Press the MAGNIFY (+) button to magnify the picture.  
To move the magnified image, use the ▲▼◀▶ button.

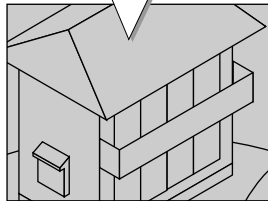
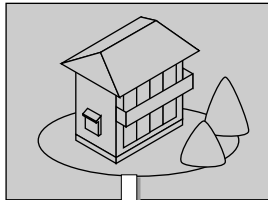
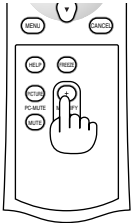

2. Press the MAGNIFY (-) button to return the image to the original size.

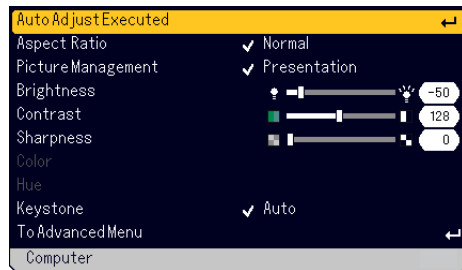
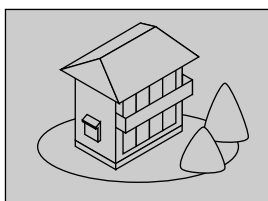
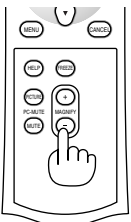

2. Rotate the SELECT +/- dial to select [To Advanced Menu] and press the ENTER button.  
The Advanced menu will be displayed.

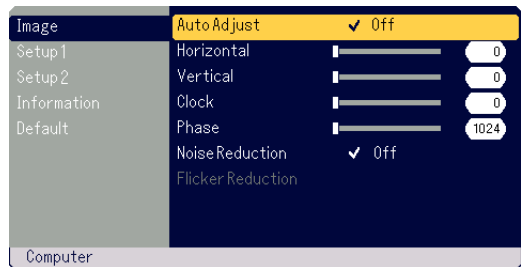



## CONVENIENT FEATURES

3. Rotate the **SELECT +/-** dial to select [Setup1] - [Security] and press the **ENTER** button.  
The Security menu will be displayed.

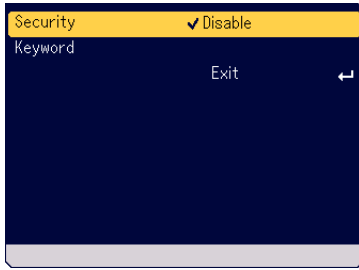

4. Rotate the **SELECT +/-** dial to select [Keyword] and press the **ENTER** button.  
The software keyboard will be displayed.

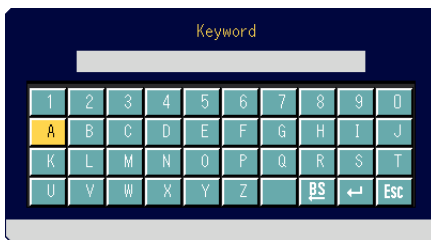

5. Use the **SELECT +/-** dial to type a keyword in the Input field.  
Selected characters will be displayed in Input field.  
\* The keyword must be no more than 10 alphanumeric characters.

### Typing a keyword

- \* To select a character, rotate the **SELECT +/-** dial to highlight the character you want to select and press the **ENTER** button.
  - \* To delete a character, rotate the **SELECT +/-** dial to highlight **BS** and press the **ENTER** button. The character at the far right will be deleted.
  - \* For the selected keyword to take effect, rotate the **SELECT +/-** dial to highlight **Esc** and press the **ENTER** button.
  - \* To cancel the selected keyword, rotate the **SELECT +/-** dial to highlight **BS** and press the **ENTER** button.
6. After finishing typing keyword, rotate the **SELECT +/-** dial to highlight [Exit] and press the **ENTER** button.  
The confirmation screen will be displayed.

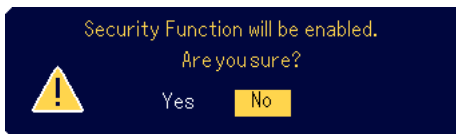

7. Rotate the **SELECT +/-** dial to select [Yes] and press the **ENTER** button.  
The Security function is enabled.

### To turn on the projector when Security is enabled:

1. Press and hold the **POWER (ON/STAND BY)** button for a minimum of 2 seconds.  
The projector will turn on and display a message to the effect that the projector is security-protected.
2. Press the **MENU** button.  
The Keyword input screen will be displayed.

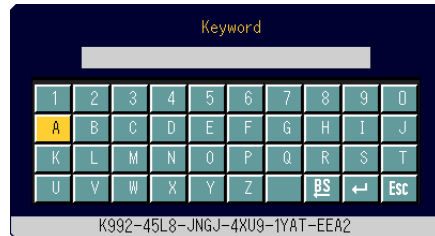

3. Enter your keyword.  
For entering your keyword, see Step 5 in "To set a keyword".
4. Select **Esc** and press the **ENTER** button.  
The Security is unlocked. You can view a projected image.

The unlock condition is maintained until the main power is turned off by unplugging the power cable.

## CONVENIENT FEATURES

### To disable the Security function:

1. Press the MENU button.  
The Basic menu will be displayed.

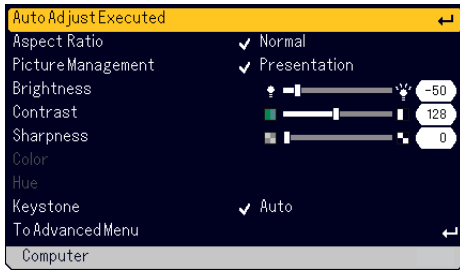

2. Rotate the SELECT +/- dial to select [To Advanced Menu] and press the ENTER button.  
The Advanced menu will be displayed.

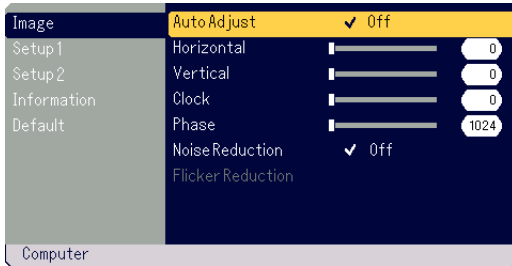

3. Rotate the SELECT +/- dial to select [Setup1] - [Security] and press the ENTER button.  
The Keyword input screen will be displayed.

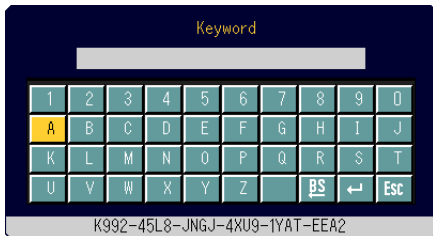

4. Enter your keyword.  
For entering your keyword, see Step 5 in "To set a keyword".
5. Rotate the SELECT +/- dial to select [ ] and press the ENTER button.  
The Security is unlocked. The Security menu will be displayed.
6. Rotate the SELECT +/- dial to select [Security] and press the ENTER button.
7. Rotate the SELECT +/- dial to select [Disable] and press the ENTER button.  
This will disable the Security function and return to the Security menu.
8. Rotate the SELECT +/- dial to select [Exit] and press the ENTER.
9. Press the MENU button to close the menu.

**NOTE:**  
If you forget your keyword, contact your dealer. Your dealer will provide you with your keyword in exchange for your request code. Your request code is displayed in the Keyword input screen. In this example "K992-45L8-JNGJ-4XU9-1YAT-EEA2" is a request code.

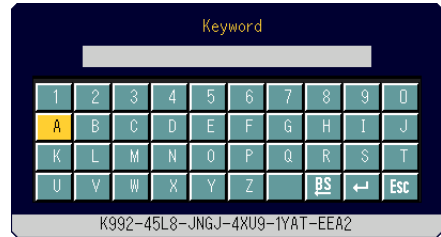

# USING ON-SCREEN MENU

## Basic Menu Operation

The Menu consists of Basic and Advanced. While the Basic menu contains minimum essentials of menus and commands, the Advanced menu contains all the available menus and commands.

The Basic menu is accessed by pressing the MENU button. Selecting "To Advanced Menu" in Basic menu will go to the Advanced menu.

## Using the Menus

### For Basic menu

1. Press the MENU button to display the Basic menu.

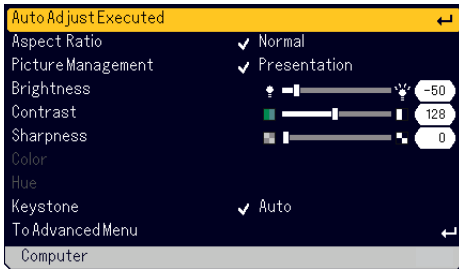

2. Rotate the SELECT +/- dial to highlight the menu item you want to adjust or set.  
The example below is for Picture Management.

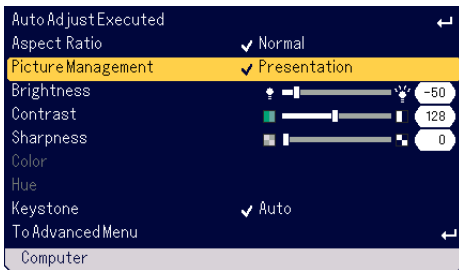

3. Press the ENTER button.  
The Picture Management item will be displayed on its right side.

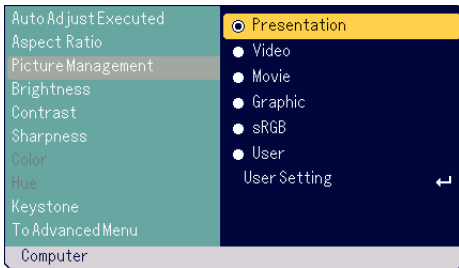

4. Rotate the SELECT +/- dial to highlight the item you want to adjust or set.  
The example below is for Graphic.

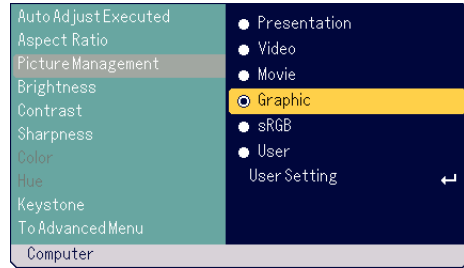

5. Press the ENTER button.  
The item is selected. This will return to the Basic menu.
6. Press the MENU button to close the menu.

### NOTE:

- \* The menu will automatically disappear if no operation is made for 45 seconds.
- \* The menu display time (default 45 seconds) can be changed. See page E-33.
- \* The on-screen menu may not be displayed correctly while interlaced motion video image is projected.

### For Advanced menu

1. Press the MENU button to display the Basic menu.

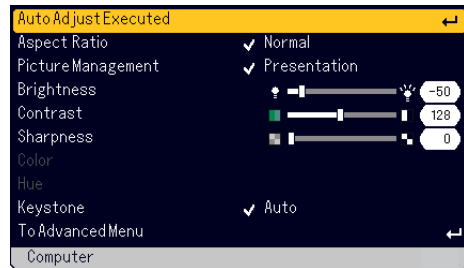

2. Rotate the SELECT +/- dial to highlight [To Advanced menu] and press the ENTER button.  
The Advanced menu will be displayed.

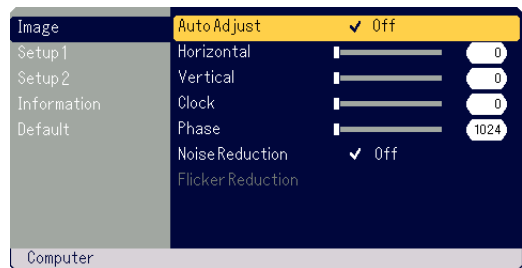

### 3. Rotate the SELECT +/- dial clockwise.

Keep rotating the SELECT +/- dial until the highlight reaches [Noise Reduction]. When the highlight reaches [Flicker Reduction], [Setup 1] menu will be displayed.

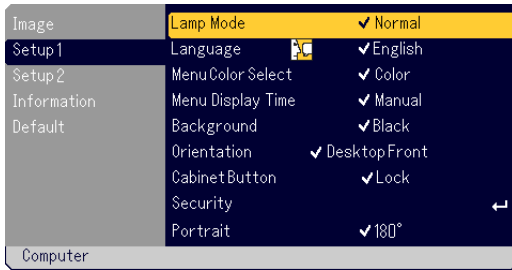

Keep rotating the SELECT +/- dial clockwise and the menu items will sequence as follows: [Image] → [Setup 1] → [Setup 2] → [Information] → [Default] → [Image] → ...

Keep rotating the SELECT +/- dial counterclockwise and the menu items will sequence as follows: [Default] → [Information] → [Setup 2] → [Setup 1] → [Image] → [Default] → ...

### 2. Press the ENTER button.

The selected item will be displayed.

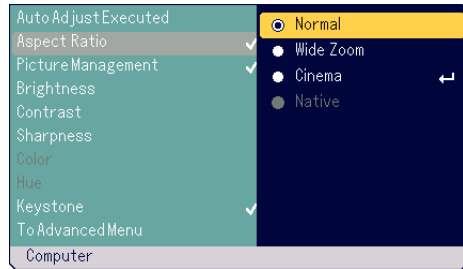

### 3. Rotate the SELECT +/- dial to highlight the item you want to set.

### 4. Press the ENTER button.

This will return to the previous menu.

#### NOTE:

The ENTER/SOURCE button on the cabinet works as:

- \* Execute menu selection.
- \* Adjust the slide bar.
- \* Display the submenu

## Adjusting and Setting Items

### For Adjusting items

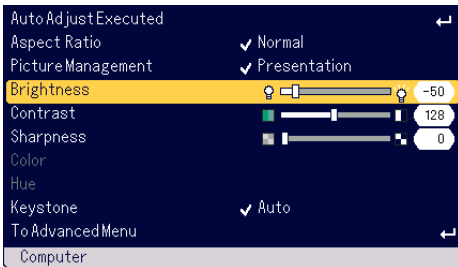

1. Rotate the SELECT +/- dial to highlight the menu item you want to adjust.

2. Press the ENTER button.

3. Rotate the SELECT +/- dial to adjust the item.

4. Press the ENTER button.

Changes will take effect.

### For Selecting items

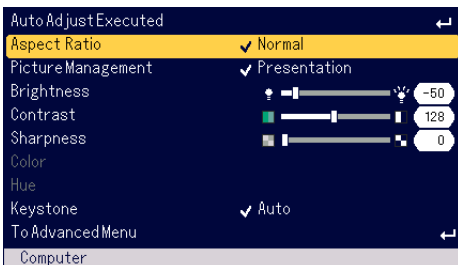

1. Rotate the SELECT +/- dial to highlight the menu item you want to set.

## List of Menu Items

### Basic Menu

Menu items	Items
Auto Adjust Executed	
Aspect Ratio	Normal, Wide, Zoom, Cinema, Native
Picture Management	Presentation, Video, Movie, Graphic, sRGB, User
	User Setting
	Base Setting (Presentation, Video, Movie, Graphic, sRGB)
	Gamma Correction (Dynamic, Black Detail, Natural)
	Brightness R
	Brightness G
	Brightness B
	Contrast R
	Contrast G
Contrast B	
	White Peaking
Brightness	
Contrast	
Sharpness	
Color	
Hue	
Keystone	Auto, Manual, Manual (Save)
To Advanced Menu	

### Advanced Menu

Category	Menu items	Items	
Image	Auto Adjust	On, Off	
	Horizontal		
	Vertical		
	Clock		
	Phase		
	Noise Reduction	On, Off	
	Flicker Reduction	On, Off	
Setup 1	Lamp Mode	Normal, Eco	
	Language	English, Deutsch, Français, Italiano, Español, Svenska, 日本語, 中文, 한국어, Português, Nederlands, Suomi, Ελληνικά, Magyar, Norsk, Polski, Русский, Türkçe, Česky, عربي	
	Menu Color Select	Color, Monochrome	
	Menu Display Time	Manual, Auto 5 sec, Auto 15 sec, Auto 45 sec	
	Background	Blue, Black, Logo	
	Orientation	Desktop Front, Ceiling Rear, Desktop Rear, Ceiling Front	
	Cabinet Button	Lock, Unlock	
	Security	Security (Enable, Disable) Keyword	
	Portrait	0°, 180°	
Setup 2	Power Management	On, Off	
	Auto Start	On, Off	
	Fan Mode	High, Auto	
	Signal Select	Computer	RGB/Component, RGB, Component, Scart
		Video	Auto, NTSC3.58, NTSC4.43, PAL, PAL-M, PAL-N, PAL60, SECAM
	S-Video	Auto, NTSC3.58, NTSC4.43, PAL, PAL-M, PAL-N, PAL60, SECAM	
Information	Page 1	Source Index, Horizontal Frequency, Vertical Frequency, Sync Polarity	
	Page 2	Signal Type, Video Type, Sync Type, Interlace	
	Page 3	Remaining Lamp Time, Lamp Hour Meter, Projector Usage	
	Page 4	Version (BIOS, Firmware, Data, GUI)	
Default	Factory Default (Current Signal)		
	Factory Default (All Data)		
	Clear Lamp Hour Meter		

**Menu Elements**

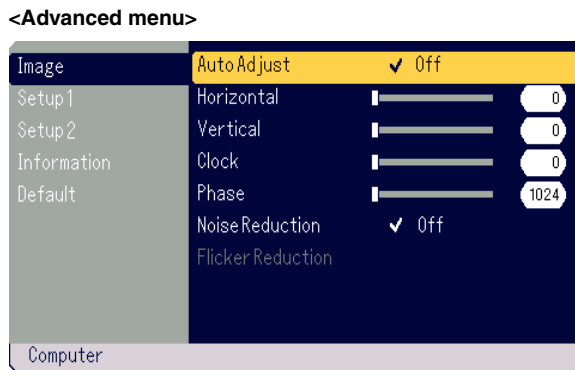
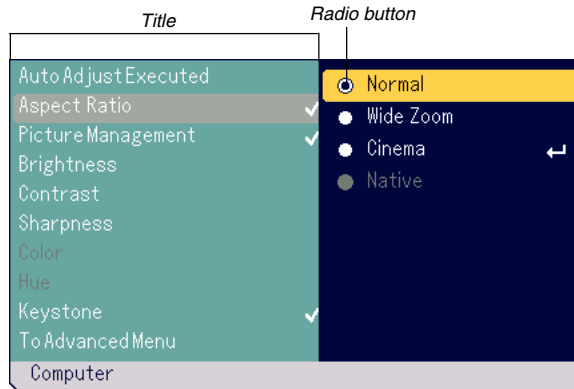
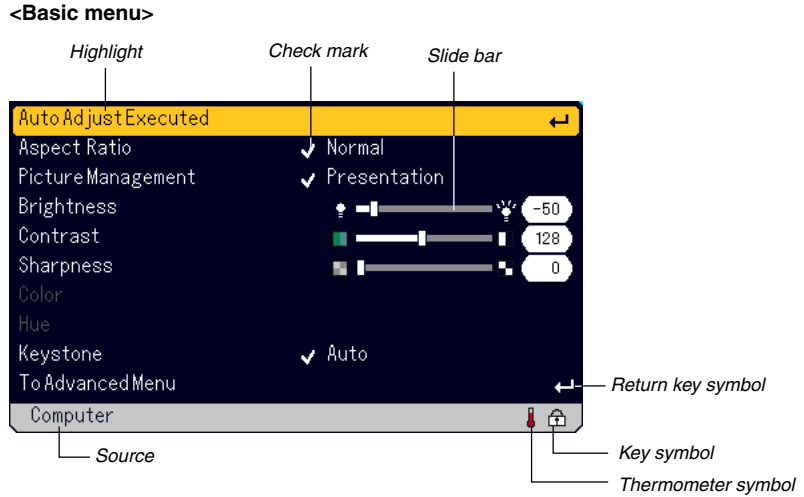

Menu windows or dialog boxes typically have the following elements:

- Title ..... Indicates the menu title.
- Highlight ..... Indicates the selected menu or item.
- Source ..... Indicates the currently selected source.
- Return key symbol .... Indicates further choices are available.
- Radio button ..... Use this round button to select an option in a dialog box.
- Check mark ..... Indicates the item is selected.
- Slide bar ..... Indicates settings or the direction of adjustment.
- Key symbol ..... Indicates the Cabinet Button is locked.
- Thermometer symbol ..... Indicates the lamp mode is forcibly set to Eco mode because the internal temperature is too high.

## Menu Descriptions & Functions

### Basic Menu

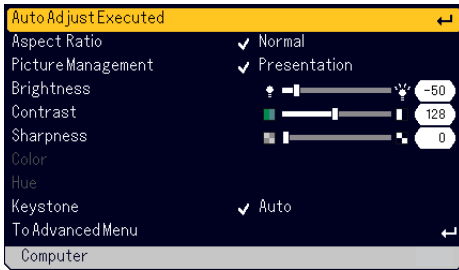

#### [Auto Adjust Executed]

Optimizing RGB image automatically. (See page E-21)

#### Selecting Aspect Ratio [Aspect Ratio]

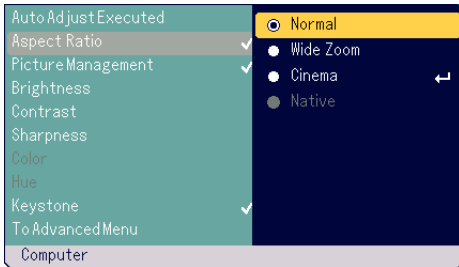

Aspect Ratio allows you to select the best Aspect mode to display your source image. You can also display the Aspect Ratio window by pressing the "ASPECT" button on the remote control. (See page E-8).

When 4:3 is selected from the source (i.e. DVD player), the following selections will display:

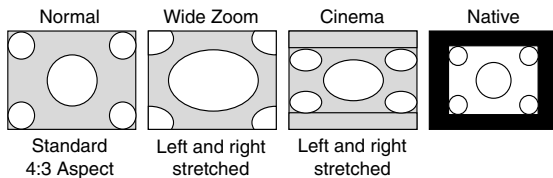

When 16:9 is selected from the source (i.e. DVD player), the following selections will display:

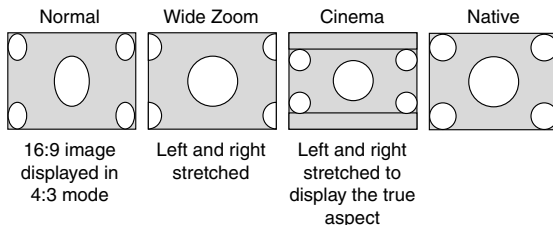

Native (COMPUTER only): Turns off the Advanced AccuBlend feature. The projector displays the current image in its true resolution.

#### NOTE:

\* While you are displaying an image with higher resolution than the projector's native resolution, "Native" is not available.

\* Selecting "Cinema" will display the Cinema Position slide bar which allows you to adjust the vertical position of the image on the screen.

#### Copyright

Please note that using this projector for the purpose of commercial gain or the attraction of public attention in a venue such as a coffee shop or hotel and employing compression or expansion of the screen image with a "Aspect Ratio" setting may raise concern about the infringement of copyrights which are protected by copyright law.

### [Picture Management]

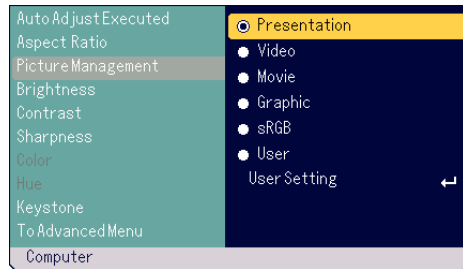

This option allows you to adjust neutral tint for yellow, cyan or magenta. There are 5 factory presets optimized for various types of images, or you can set user adjustable settings.

- Presentation .. Recommended for making a presentation using a PowerPoint file
- Video ..... Recommended for regular picture such as TV program
- Movie ..... Recommended for movie
- Graphic ..... Recommended for graphics
- sRGB ..... Standard color values
- User ..... User adjustable

**NOTE:** When "sRGB", "Graphic", "Video" or "Movie" is selected, the brightness decreases slightly when compared to "Presentation". This is not a malfunction.

#### User Setting (when using User)

When selecting a user adjustable preset (User Setting), the submenu will be displayed.

You can customize each gamma or color. To do so, first select "User Setting" and press the ENTER button, and then proceed with the following steps.

#### Selecting Base Setting [Base setting]

This feature allows you to use white balance or gamma values as reference data to optimize for various types of images. You can select one of the following five settings.

- Presentation
- Video
- Movie
- Graphic
- sRGB

#### Selecting Gamma Correction Mode [Gamma Correction]

Each mode is recommended for :

- Dynamic ..... For true color reproduction of natural tones
- Natural ..... Normal settings
- Black Detail .... For dark portions of a picture

**Adjusting White Balance [Brightness R/G/B, Contrast R/G/B]**

This allows you to adjust the white balance. Brightness for each color (RGB) is used to adjust the black level of the screen; Contrast for each color (RGB) to adjust the white level of the screen.

**Selecting White Peaking [White Peaking]**

Adjust the brightness of the white areas. As the picture becomes dim, it looks more natural.

**NOTE:** The White Peaking option is not available when "Presentation" is selected in "Base Setting".

**[Brightness]**

Adjusts the brightness level or the back raster intensity.

**[Contrast]**

Adjusts the intensity of the image according to the incoming signal.

**[Sharpness]**

Controls the detail of the image for Video.

**[Color]**

Increases or decreases the color saturation level (not valid for RGB).

**[Hue]**

Varies the color level from +/- green to +/-blue. The red level is used as reference. This adjustment is only valid for Video and Component inputs (not valid for RGB).

**NOTE:** Some Picture items cannot be available depending on the input signal.

Input signal	Brightness	Contrast	Sharpness	Color	Hue
RGB (Computer)	Yes	Yes	Yes	No	No
Component (Computer)	Yes	Yes	Yes	Yes*1	No
Video and S-Video	Yes	Yes	Yes	Yes	Yes*2

Yes: Available No: Not available

\*1 Available on DVD (15 kHz), but not available on HDTV, 525p (480p) and 750p (720p).

\*2 Available on NTSC only.

**Correcting Vertical Keystone Distortion [Keystone]**

Corrects vertical keystone distortion.

Auto ..... Corrects vertical keystone distortion automatically. See page E-20.

Manual ..... Allows you to manually correct vertical keystone distortion.

Manual (Save) This option enables you to save your current keystone correction settings. The settings are saved when you turn off the projector.

When you select "Manual" or "Manual (Save)", you can correct keystone distortion using the Keystone slide bar.

**Advanced Menu**

**[Image]**

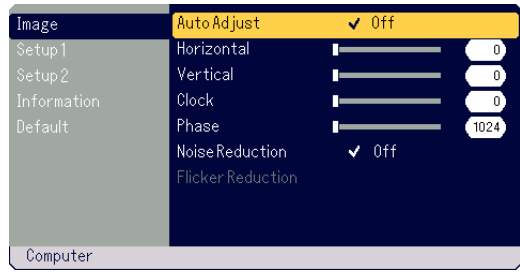

**Enabling Auto Adjust [Auto Adjust]**

When "Auto Adjust" is set to "On", the projector automatically determines the best resolution for the current RGB input signal to project an image using NEC's Advanced AccuBlend Intelligent Pixel Blending Technology. The image can be automatically adjusted for position and stability; "Horizontal Position", "Vertical Position", "Clock" and "Phase".

On ..... Automatically adjusts image "Horizontal Position", "Vertical Position", "Clock" and "Phase".

Off ..... User can adjust the image display functions ("Horizontal Position", "Vertical Position", "Clock" and "Phase") manually.

**Adjusting Position/Clock (when Auto Adjust is off)**

This allows you to manually adjust the image horizontally and vertically, and adjust Clock and Phase.

**[Horizontal/Vertical]**

Adjusts the image location horizontally and vertically.

This adjustment is made automatically when the Auto Adjust is turned on.

**[Clock]**

Use this item with the "Auto Adjust off" to fine tune the computer image or to remove any vertical banding that might appear. This function adjusts the clock frequencies that eliminate the horizontal banding in the image. This adjustment may be necessary when you connect your computer for the first time. This adjustment is made automatically when the Auto Adjust is turned on.

**[Phase]**

Use this item to adjust the clock phase or to reduce video noise, dot interference or cross talk. (This is evident when part of your image appears to be shimmering.)

Use "Phase" only after the "Clock" is complete.

This adjustment is made automatically when the Auto Adjust is turned on.

**Turning On Noise Reduction [Noise Reduction]**

Reduces video noise.

**NOTE:** The lower the Noise Reduction level, the better the image quality by way of higher video bandwidth.

**Turning On Flicker Reduction [Flicker Reduction]**

Reduces flicker which can occur in an interlaced signal.

**NOTE:** When the Flicker Reduction is ON, jagged lines can be visible depending on the signal. In that case, select OFF.



[Setup1]

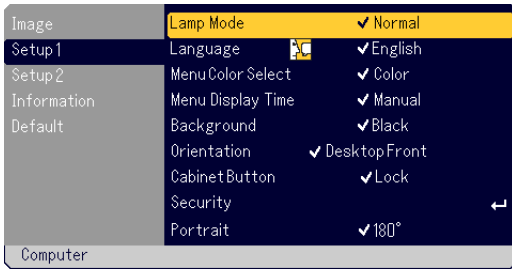

**Selecting Lamp Mode [Lamp Mode]**

This feature enables you to select two brightness modes of the lamp: Normal and Eco modes. The lamp life can be extended by using the Eco mode.

Normal Mode ... This is the default setting (100% Brightness).

Eco Mode ..... Select this mode to increase the lamp life (80% Brightness).

**NOTE:** Thermometer symbol  indicates the lamp mode is forcibly set to Eco mode because the internal temperature is too high.

**Selecting Menu Language [Language]**

You can choose one of 20 languages for on-screen instructions.

**Selecting Menu Color [Menu Color Select]**

You can choose between two color modes for menu color: color and monochrome.

**Selecting Menu Display Time [Menu Display Time]**

This option allows you to select how long the projector waits after the last touch of a button to turn off the menu.

The preset choices are "Manual", "Auto 5 sec", "Auto 15 sec", and "Auto 45 sec". The "Auto 45 sec" is the factory preset.

**Selecting a Color or Logo for Background [Background]**

Use this feature to display a black/ blue screen or logo when no signal is available.

**Selecting Projector Orientation [Orientation]**

This sets the orientation of the image for your type of application. The options are:

desktop front projection, ceiling rear projection, desktop rear projection, and ceiling front projection.

**Disabling the Cabinet Buttons [Cabinet Button]**

This option turns on or off the Cabinet Button Lock function.

**NOTE:**  
 \* This Cabinet Button Lock does not affect the remote control functions.  
 \* When the cabinet buttons are locked, pressing and holding the MENU button for about 10 seconds will change the setting to unlock.  
 \* Key symbol  indicates the Cabinet Button is locked.

**Enabling Security function [Security]**

This option allows you to prevent the projector from being used by unauthorized individuals.  
 See page E-24 for details.

**Selecting Display Orientation [Portrait]**

This allows you to select the projector's display orientation when you display an image in portrait mode with the projector on its side. See page E-13. You can rotate the projected image 0° or 180° clockwise depending on your PC.  
 The default setting is 180°.

[Setup2]

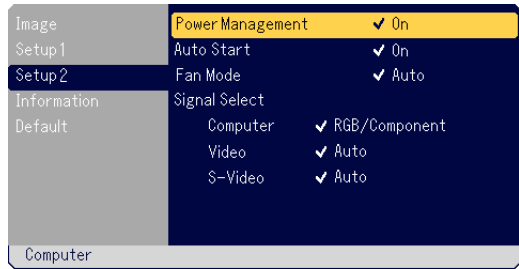

**Enabling Power Management [Power Management]**

When this option is on and there is no input for five minutes or more, the projector will automatically turn itself off.

**Enabling Auto Start [Auto Start]**

Turns the projector on automatically when the power cable is inserted into an active power outlet.

This eliminates the need to always use the POWER (ON/STAND BY) button on the projector cabinet or the POWER OFF button on the remote control.

**Enabling High Speed Fan Mode [Fan Mode]**

This option allows you to select two modes for fan speed: High mode and Auto mode.

High ..... The built-in fans run at a fixed high speed.

Auto ..... The built-in fans automatically run at a variable speed according to the internal temperature.

When you wish to cool down the temperature inside the projector quickly, select "High".

**NOTE:** Select High Speed Fan mode if you continue to use the projector for consecutive days.

**Selecting Signal Format [Signal Select]**

<Computer>  
 Allows you to choose "RGB" for an RGB source such as a computer, or "Component" for a component video source such as a DVD player. Normally select "RGB/Component" and the projector automatically detects a component signal. However there may be some component signals that the projector is unable to detect. If this is the case, select "Component". Select "Scart" for the European Scart.

<Video & S-Video>  
 This feature enables you to select composite video standards manually. Normally select "Auto".  
 When you select the video standard for Video and S-Video, select the video standard from the pull-down menu.  
 This must be done for Video and S-Video respectively.

**Information**

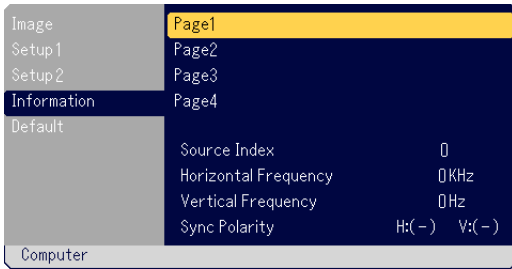

Displays the status of the current signal and lamp usage. This item has four pages. The information included is as follows:

- |                      |                                  |
|----------------------|----------------------------------|
| [Page 1]             | [Page 3]                         |
| Source Index         | Remaining Lamp Time (%)*         |
| Horizontal Frequency | Lamp Hour Meter (H)              |
| Vertical Frequency   | Projector Usage                  |
| Sync Polarity        |                                  |
| [Page 2]             | [Page 4]                         |
| Signal Type          | Version (BIOS/Firmware/Data/GUI) |
| Video Type           |                                  |
| Sync Type            |                                  |
| Interface            |                                  |

\* The progress indicator shows the percentage of remaining lamp life. The value informs you of the amount of lamp usage. When the remaining lamp time reaches 0, the Remaining Lamp Time bar indicator changes from 0% to 100 Hours and starts counting down. If the remaining lamp time reaches 0 hours, the projector will not turn on regardless of whether the lamp mode is set to Normal or Eco.

**Default**

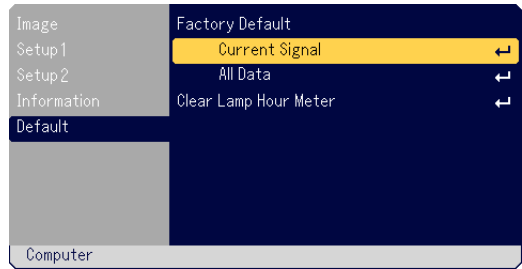

**Returning to Factory Default [Factory Default]**

The Factory Default feature allows you to change adjustments and setting to the factory preset for source except the following:

<Current Signal>

Resets the adjustments for the current signal to the factory preset levels. The items that can be reset are: Brightness, Contrast, Color, Hue, Sharpness, Aspect Ratio, Horizontal Position, Vertical Position, Clock, Phase and Picture Management.

<All Data>

Reset all the adjustments and settings for all the signals to the factory preset. The items can be reset except Language, Security, Remaining Lamp Time, Lamp Hour Meter and Projector Usage. To reset the lamp usage time, see "Clear Lamp Hour Meter".

**Clearing Lamp Hour Meter [Clear Lamp Hour Meter]**

Resets the lamp clock back to zero. Selecting this option displays submenu for a confirmation.

**NOTE:** The projector will turn off and go into standby mode after 1600 hours (up to 2100 hours in Eco mode) of service. If this happens, press the "HELP" button on the remote control for ten seconds to reset the lamp clock back to zero. Do this only after replacing the lamp.

# MAINTENANCE

This section describes the simple maintenance procedures you should follow to replace the lamp and clean the filter.

## Replacing the Lamp

After your lamp has been operating for 1500 hours (up to 2000 hours in Eco mode) or longer, the LAMP indicator in the cabinet will blink red and the message will appear. Even though the lamp may still be working, replace it at 1500 (up to 2000 hours in Eco mode) hours to maintain optimal projector performance.

### CAUTION

- **DO NOT TOUCH THE LAMP** immediately after it has been used. It will be extremely hot. Turn the projector off, wait 60 seconds, and then unplug the power cable. Allow at least one hour for the lamp to cool before handling.
- **DO NOT REMOVE ANY SCREWS** except the lamp cover screw and the lamp case screw. You could receive an electric shock.
- The projector will turn off and go into stand by mode after 1600 (up to 2100 hours in Eco mode) hours of service. If this happens, be sure to replace the lamp. If you continue to use the lamp after 1500 hours (up to 2000 hours in Eco mode) of use, the lamp bulb may shatter, and pieces of glass may be scattered in the lamp case. Do not touch them as the pieces of glass may cause injury. If this happens, contact your NEC dealer for lamp replacement.

### To replace the lamp:

**NOTE:** The replacement lamp comes with a flat-blade screwdriver. Use the screwdriver to remove the lamp cover and lamp housing.

1. Loosen the lamp cover screw until the screwdriver goes into a free-wheeling condition. Press firmly and slide the lamp cover off. The lamp cover screw is not removable.

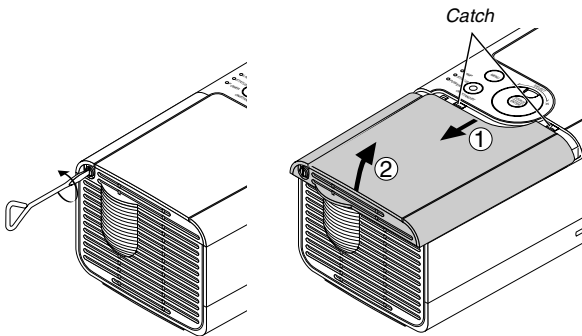

2. Loosen the screw securing the lamp housing until the screwdriver goes into a free-wheeling condition. The screw is not removable.

Remove the lamp housing by pulling out the handle.

**NOTE:** There is an interlock on this case to prevent the risk of electrical shock. Do not attempt to circumvent this interlock.

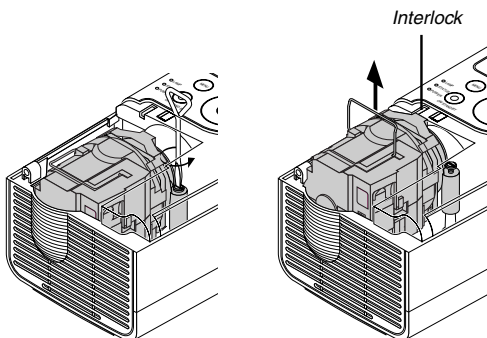

3. Insert a new lamp housing until the lamp housing is plugged into the socket.

### CAUTION

Do not use a lamp other than the NEC replacement lamp (LT70LP). Order this from your NEC dealer.

Secure it in place with the screw.  
Be sure to tighten the screw.

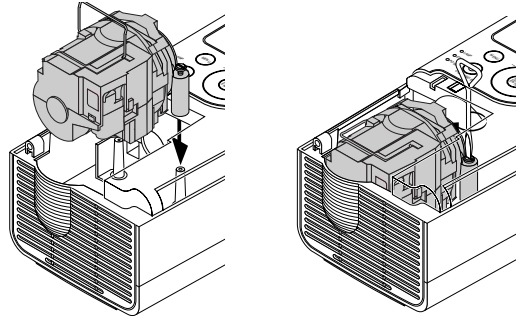

4. Reattach the lamp cover. Slide the lamp cover back until it snaps into place.

Tighten the lamp cover screw.  
Be sure to tighten the screw.

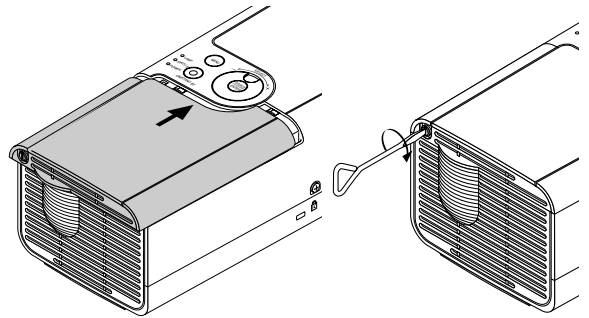

5. After you install a new lamp, select the menu → [Default] → [Clear Lamp Hour Meter] to reset the lamp usage hours.

**NOTE:** When the lamp exceeds 1600 hours (up to 2100 hours in Eco mode) of service, the projector cannot turn on and the menu is not displayed. If this happens, press the Help button on the remote control for a minimum of 10 seconds while in standby mode. When the lamp time clock is reset to zero, the LAMP indicator goes out.

**Cleaning the Cabinet and the Lens**

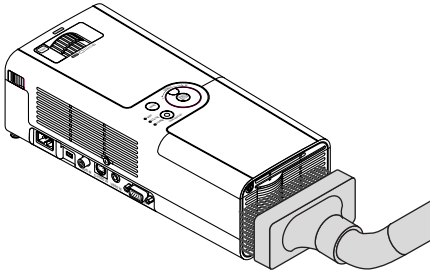

1. *Turn off the projector before cleaning.*
2. *Clean the cabinet periodically with a damp cloth. If heavily soiled, use a mild detergent. Never use strong detergents or solvents such as alcohol or thinner.*
3. *Use a blower or lens paper to clean the lens, and be careful not to scratch or mar the lens.*

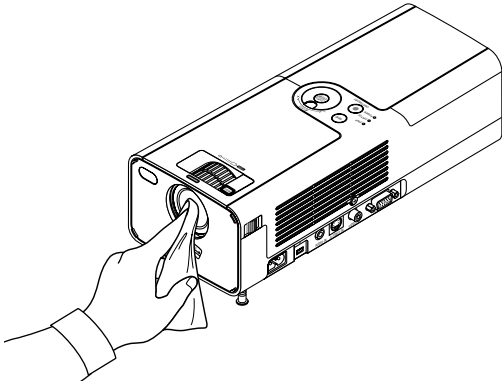

# TROUBLESHOOTING

This section helps you resolve problems you may encounter while setting up or using the projector.

## Power Indicator (POWER)

Indicator Condition			Projector Condition	Note
Off			The main power is not supplied	–
Blinking light	Green	0.5 sec ON, 0.5 sec OFF	The projector is getting ready to turn on.	Wait for a moment.
	Orange	0.5 sec ON, 0.5 sec OFF	The projector is cooling down.	Wait for a moment.
Steady light	Green		The projector is turned on.	–
	Orange		The projector is in Standby.	–

## Status Indicator (STATUS)

Indicator Condition			Projector Condition	Note
Off			Normal	–
Blinking light	Red	1 cycle (0.5 sec ON, 2.5 sec OFF)	Lamp cover error or lamp housing error	Replace the lamp cover or lamp housing correctly.
		2 cycle (0.5 sec ON, 0.5 sec OFF)	Temperature error	The projector is overheated. Move the projector to a cooler location.
		3 cycle (0.5 sec ON, 0.5 sec OFF)	Power Failure	Power supply unit will not work correctly. Contact your dealer.
		4 cycle (0.5 sec ON, 0.5 sec OFF)	Fan error	Fans will not work correctly.
		6 cycle (0.5 sec ON, 0.5 sec OFF)	Lamp error	Lamp fails to light. Wait a full minute and then turn on again.
	Green		Re-firing the lamp	The projector is re-firing.
Steady light	Orange		Cabinet button is locked	You have pressed cabinet button when Cabinet Button is locked.

## Lamp Indicator (LAMP)

Indicator Condition			Projector Condition	Note
Off			Normal	–
Blinking light	Red		Lamp has reached its end of life. Lamp replacement message will be displayed.	Replace the lamp.
Steady light	Red		Lamp has been used beyond its limit. The projector will not turn on until the lamp is replaced.	Replace the lamp.
	Green		Lamp mode is set to Eco mode	–

**Common Problems & Solutions**

<b>Problem</b>	<b>Check These Items</b>
Does not turn on	<ul style="list-style-type: none"> <li>• Check that the power cable is plugged in and that the power button on the projector cabinet or the remote control is on. See page E- 17.</li> <li>• Check to see if the Cabinet Button Lock function is enabled.If this function is enabled, cancel it by pressing and holding the MENU button on the cabinet for a minimum of 10 seconds or using the menu with the remote control. See page E-33.</li> <li>• Ensure that the lamp cover or lamp housing is installed correctly. See page E-35.</li> <li>• Check to see if the projector has overheated or the lamp has reached the end of its usable life. If there is insufficient ventilation around the projector or if the room where you're presenting is particularly warm, move the projector to a cooler location.</li> </ul>
No picture	<ul style="list-style-type: none"> <li>• Use the COMPUTER, VIDEO or S-VIDEO button on the remote control or the SOURCE button on the cabinet to select your source (Computer, Video or S-Video). See page E-19.</li> <li>• Ensure your cables are connected properly.</li> <li>• Use menus to adjust the brightness and contrast. See page E-32.</li> <li>• Open the lens shutter. See page E-18.</li> <li>• Reset the settings or adjustments to factory preset levels using "Factory Default" in the menu. See page E-34.</li> <li>• Enter your registered keyword if the Security function is enabled. See page E-24.</li> <li>• When using with a notebook PC, be sure to connect between the projector and the notebook PC before turning on the power to the notebook PC. In most cases signal cannot be output from RGB output unless the notebook PC is turned on after connecting with the projector.</li> <li>• If the screen goes blank while using your remote control, it may be the result of the computer's screen-saver or power management software.</li> <li>• If you accidentally hit the POWER button on the remote control, wait 60 seconds and then press the POWER button again to resume.</li> </ul>
Image isn't square to the screen	<ul style="list-style-type: none"> <li>• Reposition the projector to improve its angle to the screen. See page E-19.</li> <li>• Use the Keystone correction function to correct the trapezoid distortion. See page E-20.</li> </ul>
Picture is blurred	<ul style="list-style-type: none"> <li>• Adjust the focus. See page E-20.</li> <li>• Reposition the projector to improve its angle to the screen. See page E-19.</li> <li>• Ensure that the distance between the projector and screen is within the adjustment range of the lens. See page E-11.</li> <li>• Condensation may form on the lens if the projector is cold, brought into a warm place and is then turned on. Should this happen, let the projector stand until there is no condensation on the lens.</li> </ul>
Image is scrolling vertically, horizontally or both	<ul style="list-style-type: none"> <li>• Use the COMPUTER, VIDEO or S-VIDEO button on the remote control or the SOURCE button on the cabinet to select the source you want to input. See page E-19.</li> </ul>
Remote control does not work	<ul style="list-style-type: none"> <li>• Install new batteries. See page E-9.</li> <li>• Make sure there are no obstacles between you and the projector.</li> <li>• Stand within 22 feet (7 m) of the projector. See page E-9.</li> </ul>
Indicator is lit or blinking	<ul style="list-style-type: none"> <li>• See the Power/Status/Lamp Indicator on page E-37.</li> </ul>
Cross color in RGB mode	<ul style="list-style-type: none"> <li>• If Auto Adjust is off, turn it on or adjust the image manually with Horizontal / Vertical / Clock / Phase in the menu. See page E-32.</li> </ul>

# SPECIFICATIONS

---

This section provides technical information about the LT170 Projector's performance

**Model Number**                    **LT170**

## Optical

DMD                                    Single Chip Digital Micromirror Device (DMD)  
Resolution                            1024 × 768 pixels native\*, up to UXGA with Advanced AccuBlend  
Lens                                     Manual zoom and focus: F=2.0 (Wide)-2.13 (Tele), f=25.7 - 28.3mm  
Lamp                                    145W  
Image Size                            30 - 200 inches (0.8 - 5.1 m) diagonal  
Projection Distance                3.51 - 26.67 ft / 1.07 (Wide) - 8.13 m (Tele)  
Projection Angle                    Tele : 8.6°/ Wide : 9.5°  
Keystone Correction                +/- 30 degrees electronic (auto)

## Electrical

Inputs                                 1 RGB/Component (D-Sub 15 Pin), 1 S-Video (DIN 4 Pin), 1 Video (RCA), 1 Stereo Mini Audio  
Video Compatibility                NTSC, NTSC4.43, PAL, PAL-60, PAL-N, PAL-M, SECAM, HDTV: 1080i, 1080i/50Hz, 720p, 576p, 480p, 480i/60Hz  
Scan Rate                            Horizontal: 15 kHz to 100 kHz (RGB: 24 kHz or over) / Vertical: 50 Hz to 120 Hz  
Video Bandwidth                    RGB: 100 MHz (-3dB)  
Color Reproduction                16.7 million colors simultaneously, Full color  
Horizontal Resolution              NTSC / NTSC4.43/PAL/PAL-M/PAL-N/PAL60: 540 TV lines  
SECAM: 300 TV lines  
YCbCr: 540 TV lines  
RGB: 1024 dots (H) × 768 dots (V)  
External Control                    RS232, IR  
Sync Compatibility                Separate Sync / Composite Sync / Sync on G  
Built-in Speaker                    0.5W (monaural)  
Power Requirement                100 - 240V AC, 50 / 60 Hz  
Input Current                        2A (Max.)  
Power Consumption                196W(4W in Standby mode)

## Mechanical

Installation Orientation            Desktop/Front, Desktop/Rear, Ceiling/Front, Ceiling/Rear  
Dimensions                         4.8" (W) × 3.3" (H) × 11.0" (D)  
123mm (W) × 85mm (H) × 280mm (D)  
(not including protrusions)  
Net Weight                         3.9 lbs / 1.8 kg  
Environmental Considerations    Operational Temperatures : 41° to 95°F (5° to 35°C), 20% to 80% humidity (non-condensing)  
Storage Temperatures : 14° to 122°F (-10° to 50°C), 20% to 80% humidity (non-condensing)  
Regulations                        UL Approved (UL 60950, CSA 60950)  
Meets DOC Canada Class B requirements  
Meets FCC Class B requirements  
Meets AS/NZS CISPR 22 Class B  
Meets EMC Directive (EN55022:1998, EN55024-1998, EN61000-3-2, EN61000-3-3)  
Meets Low Voltage Directive (EN60950, TUV GS Approved)  
CE

For additional information visit:

US : <http://www.necvisualsystems.com>  
Europe : <http://www.nec-europe.com/>  
Global : <http://www.nec-pj.com/>

\* Effective pixels are more than 99.99%.

The specifications are subject to change without notice.

# APPENDIX

## Cabinet Dimensions

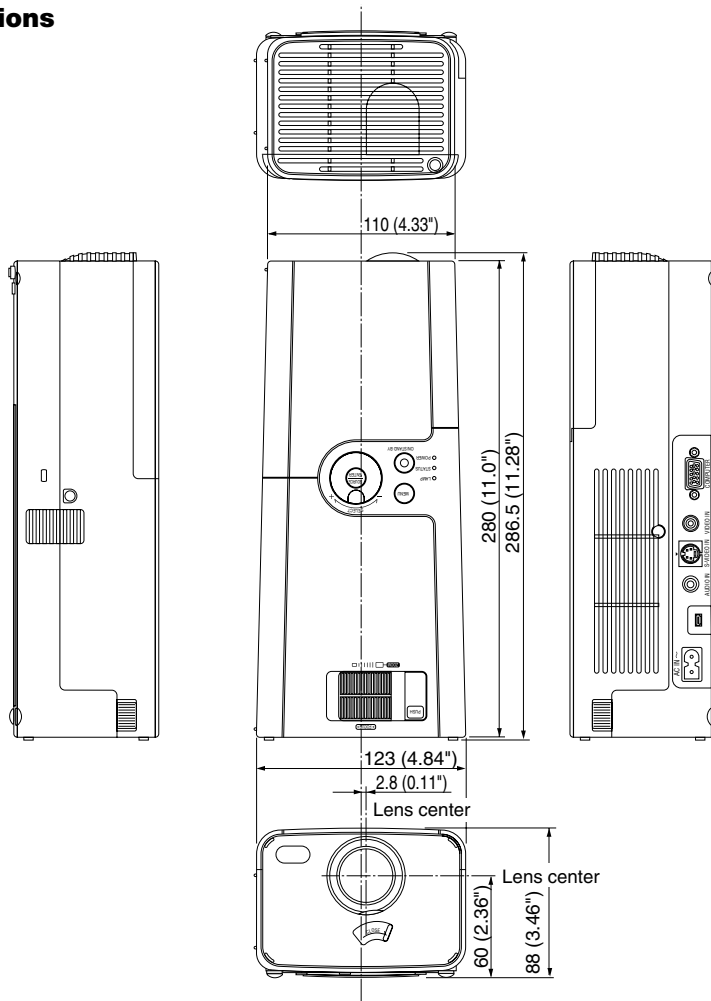

Unit = mm (inch)

## Pin Assignments of D-Sub COMPUTER Input Connector

### Mini D-Sub 15 Pin Connector

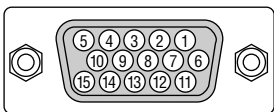

Signal Level  
 Video signal : 0.7Vp-p (Analog)  
 Sync signal : TTL level

Pin No.	RGB Signal (Analog)	YCbCr Signal
1	Red	Cr
2	Green or Sync on Green	Y
3	Blue	Cb
4	Ground	
5	Ground	
6	Red Ground	Cr Ground
7	Green Ground	Y Ground
8	Blue Ground	Cb Ground
9	No Connection	
10	Sync Signal Ground	
11	Scart Sync	
12	Bi-directional DATA (SDA)	
13	Horizontal Sync or Composite Sync	
14	Vertical Sync	
15	Data Clock	



## Compatible Input Signal List

Signal	Resolution ( Dots )	Frequency H. ( kHz )	Refresh Rate ( Hz )
NTSC	–	15.734	60
PAL	–	15.625	50
PAL60	–	15.734	60
SECAM	–	15.625	50
VESA	640 × 480	31.47	59.94
IBM	640 × 480	31.47	60
MAC	640 × 480	31.47	60
MAC	640 × 480	34.97	66.67
MAC	640 × 480	35	66.67
VESA	640 × 480	37.86	72.81
VESA	640 × 480	37.5	75
IBM	640 × 480	39.375	75
VESA	640 × 480	43.269	85.01
IBM	720 × 350	31.469	70.09
VESA	720 × 400	37.927	85.04
IBM	720 × 350	39.44	87.85
IBM	720 × 400	39.44	87.85
VESA	800 × 600	35.16	56.25
VESA	800 × 600	37.879	60.32
VESA	800 × 600	48.077	72.19
VESA	800 × 600	46.88	75
VESA	800 × 600	53.674	85.06
MAC	832 × 624	49.725	74.55
VESA	1024 × 768	35.5	43 Interlaced
VESA	1024 × 768	48.363	60
VESA	1024 × 768	56.476	70.07
MAC	1024 × 768	60.241	74.93
VESA	1024 × 768	60.023	75.03
VESA	1024 × 768	68.677	85
# VESA	1152 × 864	67.5	75
# MAC	1152 × 870	68.681	75.06
# SUN	1152 × 900	61.796	65.95
# SGI	1152 × 900	71.736	76.05
# VESA	1280 × 960	60	60
# VESA	1280 × 1024	63.981	60.02
# MAC	1280 × 1024	69.89	65.18
# HP	1280 × 1024	78.125	72.01
# SUN	1280 × 1024	81.13	76.11
# VESA	1280 × 1024	79.976	75.03
# VESA	1280 × 1024	91.146	85.02
# SXGA+	1400 × 1050	–	–
# SDTV(576i)(625i)	–	15.6	50
# SDTV(576p)(625p)	–	31.5	50
# HDTV (1080i)(1125i)	1920 × 1080	33.75	60 Interlace
# HDTV (1080i)(1125i)	1920 × 1080	28.125	50 Interlace
# HDTV (720p)(750p)	1280 × 720	45	60 Progressive
# SDTV (480p)(525p)	–	31.47	59.94 Progressive
# VESA	1600 × 1200	75.0	60
# VESA	1600 × 1200	81.25	65
# VESA	1600 × 1200	87.5	70
# VESA	1600 × 1200	93.75	75
DVD YCbCr	–	15.734	59.94 Interlaced
DVD YCbCr	–	15.625	50 Interlaced

# : Images in above flagged with # are compressed with Advanced AccuBlend.

**NOTE:** Some composite sync signals may not be displayed correctly.

Signals other than those specified in the table above may not be displayed correctly. If this should happen, change the refresh rate or resolution on your PC. Refer to Display Properties help section of your PC for procedures.

UXGA (1600×1200) is supported for separate sync signal only.

## TravelCare Guide

### TravelCare - a service for international travelers

This product is eligible for "TravelCare", NEC's unique international warranty.

Please note that TravelCare coverage differs in part from coverage under the warranty included with the product.

### Services offered with TravelCare

This warranty allows customers to receive service on their product at the NEC and NEC-designated service stations in the countries listed herein when temporarily traveling internationally for business or pleasure.

For details on services offered by the different service stations, please refer to the "List of TravelCare Outlets" below.

#### 1 Repair services

The product will be repaired and delivered within 10 business days, not including shipping time.

During the term of warranty, the cost of maintenance parts, labor costs for repairs and shipping costs within the service station's coverage area are covered by the warranty.

#### 2 Replacement product rental service

If the customer desires, he or she can rent a replacement product while the original product is being repaired.

Fee: US\$200 for 12 days

This fee must be paid at the local service station in cash or credit card.

The \$200 rental fee is non-refundable even if the customer rents it less than 12 days before returning.

The replacement product will be delivered within 3 business days.

If the customer did not return the replacement product within 12 days, the customer will be charged the price of the unit.

If the customer returned the replacement product in a faulty or damaged condition, the repair cost will be charged to the customer.

Note that this service is not offered in all countries and regions. Please refer to the "List of TravelCare Outlets".

In addition, this replacement product rental service is not offered after the product's warranty has expired.

### Term of warranty

1

- a. Upon presentation of the warranty or receipt received upon purchase:

*Valid for the term indicated on the warranty or the normal term of warranty for the country of purchase.*

- b. When only the product is brought in:

*Valid for a period of within 14 months of the date of manufacture indicated by the serial number attached to the product.*

2 When a product whose term of warranty is expired is brought in:

Repairs will be offered for a fee. In this case the customer is not eligible for the replacement product rental service.

3 In the following cases, repairs may be charged, even if the product's warranty is still in effect:

- 1) If the term of warranty, model name, serial number and name of the store of purchase are not indicated on the warranty or have been altered.
- 2) Problems or damage caused by dropping or shocks during shipment or movement by the customer or by improper handling by the customers.
- 3) Problems or damage caused by improper usage or unwarrantable alterations or repairs by the customer.
- 4) Problems or damage caused by fire, salt damage, gas damage, earthquakes, lightning damage, storm or flood damage or other natural disasters or such external factors as dust, cigarette smoke, abnormal voltage, etc.
- 5) Problems or damage caused by use in hot or humid places, in vehicles, boats or ships, etc.

- 6) Problems or damage caused by expendable supplies or devices connected to the product other than those designated by NEC.
- 7) Problems caused by natural consumption, wear or deterioration of parts under normal usage conditions.
- 8) Problems or damage to lamps and other expendable supplies, included parts or optional parts.
- 9) Other conditions stipulated in the warranty included with the product also apply.

**NOTE:** The product can be used overseas with voltages of 100 to 120V and 200 to 240V by using a power cable suited for the standards and power source voltage of the country in which the product is being used.

### List of TravelCare Outlets

This list applies as of June 1, 2002.

For the most up-to-date information, please refer to the websites of the service stations in the various countries on the List of TravelCare Outlets or to the NEC website at <http://www.nec-pj.com>.

#### In Europe

NEC Europe, Ltd. / European Technical Centre

Address: Unit G, Stafford Park 12, Telford TF3 3BJ, U.K.  
 Telephone: +44 1952 237000  
 Fax Line: +44 1952 237006  
 Email Address: AFR@uk.necneur.com  
 WEB Address: <http://www.necneur.com>

(Regions Covered)

EU: Austria\*, Belgium\*, Denmark\*, Finland\*, France\*, Germany\*, Greece\*, Ireland\*, Italy\*, Luxembourg\*, The Netherlands\*, Portugal\*, Spain\*, Sweden\* and the United Kingdom\*  
 EEA: Norway\*, Iceland and Liechtenstein

#### In North America

NEC Solutions (America), Inc.

Address: 1250 Arlington Heights Road, Itasca, Illinois 60143, U.S.A.  
 Telephone: +1 800 836 0655  
 Fax Line: +1 800 356 2415  
 Email Address: [vsd-tech-support@necsam.com](mailto:vsd-tech-support@necsam.com)  
 WEB Address: <http://www.necvisualsystems.com>

(Regions Covered)

U.S.A. \*, Canada\*

#### In Oceania

NEC Australia Pty., Ltd.

Address: New South Wales;  
 184 Milperra Road, Reversby 2212  
 Victoria;  
 480 Princess Hwy Noble Park 3174  
 South Australia;  
 84A Richmond Road, Keswick 5035  
 Queensland;  
 116 Ipswich Road, Woollongabba 4102  
 Western Australia;  
 45 Sarich Court Osborne Park 6017  
 Telephone: 131 632 (from domestic)  
 +61 8 8375 5706 (from overseas)  
 Fax Line: +61 8 8375 5757  
 Email Address: [lee.gramola@nec.com.au](mailto:lee.gramola@nec.com.au)  
 WEB Address: <http://www.nec.com.au>

(Regions Covered)

Australia\*, New Zealand

## APPENDIX

---

### In Asia and Middle East

#### NEC Viewtechnology, Ltd.

Address: 686-1, Nishioi, Oi-Machi, Ashigarakami-Gun,  
Kanagawa 258-0017, Japan  
Telephone: +81 465 85 2369  
Fax Line: +81 465 85 2393  
Email Address: support\_pjweb@nevt.nec.co.jp  
WEB Address: <http://www.nec-pj.com>

(Regions Covered)  
Japan\*

#### NEC Hong Kong Ltd.

Address: 11th Floor, Tower B, New Mandarin Plaza, 14  
Science Museum Road,  
Tsim Sha Tsui East, Kowloon, Hong Kong  
Telephone: +852 2369 0335  
Fax Line: +852 2795 6618  
Email Address: esmond\_au@nechk.nec.com.hk  
WEB Address: <http://www.nec.com.hk>

(Regions Covered)  
Hong Kong

#### NEC Taiwan Ltd.

Address: 7F, No.167, SEC.2, Nan King East Road, Taipei,  
Taiwan, R.O.C.  
Telephone: +886 2 8500 1734  
Fax Line: +886 2 8500 1420  
Email Address: nickliao@nec.com.tw  
WEB Address: <http://www.nec.com.tw>

(Regions Covered)  
Taiwan

#### NEC Singapore Pte. Ltd

Address: 401 Commonwealth Drive, #07-02, Haw Par  
Technocentre, Singapore 149598  
Telephone: +65 6 273 8333  
Fax Line: +65 6 274 2226  
Email Address: daniel@rsc.necsin.nec.com.sg  
WEB Address: <http://www.nec.com.sg>

(Regions Covered)  
Singapore

#### Hyosung Data System, Ltd.

Address: 7th Floor, Cheongdam Building, 52,  
Cheongdam-Dong,  
Kangnam-Ku, Seoul, Korea 135-100  
Telephone: +82 2 510 0234  
Fax Line: +82 2 540 3590  
Email Address: hds-ykc@hyosung.com

(Regions Covered)  
South Korea

#### Lenso Communication Co., Ltd.

Address: 292 Lenso House 4, 1st Floor, Srinakarin Road,  
Huamark, Bangkok, Bangkok 10240, Thailand  
Telephone: +66 2 375 2425  
Fax Line: +66 2 375 2434  
Email Address: pattara@lenso.com  
WEB Address: <http://www.lenso.com>

(Regions Covered)  
Thailand

#### ABBA Electronics L.L.C.

Address: Tariq Bin Ziyad Road, P.O.Box 327, Dubai,  
United Arab Emirates  
Telephone: +971 4 371800  
Fax Line: +971 4 364283  
Email Address: ABBA@emirates.net.ae

(Regions Covered)  
United Arab Emirates

#### Samir Photographic Supplies

Address: P.O.Box 599, Jeddah 21421, Saudi Arabia  
Telephone: +966 2 6828219  
Fax Line: +966 2 6830820  
Email Address: vartkes@samir-photo.com

(Regions Covered)  
Saudi Arabia

---

**NOTE:** In countries designated with an asterisk(\*), replacement product rental service are offered.

---

Date: / / ,

P-1/ ,

**TO: NEC or NEC's Authorized Service Station:**

**FM:**

\_\_\_\_\_  
 (Company & Name with signature)

Dear Sir (s),

I would like to apply your TravelCare Service Program based on attached registration and qualification sheet and agree with your following conditions, and also the Service fee will be charged to my credit card account, if I don't return the Loan units within the specified period. I also confirm following information is correct. Regards.

***Application Sheet for TravelCare Service Program***

Country, product purchased :	
User's Company Name :	
User's Company Address : Phone No., Fax No. :	
User's Name :	
User's Address :	
Phone No., Fax No. :	
Local Contact office :	
Local Contact office Address :	
Phone No., Fax No. :	
User's Model Name :	
Date of Purchase :	
Serial No. on cabinet :	
Problem of units per User :	
Required Service :	(1) Repair and Return      (2) Loan unit
Requested period of Loan unit :	
Payment method :	(1) Credit Card      (2) Travelers Cheque      (3) Cash
In Case of Credit Card : Card No. w/Valid Date :	

**Condition of your TravelCare Service Program**

Enduser is requested to understand following conditions of TravelCare Service Program and complete the necessary information on the application sheet.

**1. Service Options:**

There are 3 types of "Service" available. Enduser has to understand following condition and is required to fill in the Application Sheet.

1) Repair and Return:

The 'Faulty unit' is sent or collected from the customer. It is repaired and returned within 10 days to the customer, excluding transport time.

There may have a case, repair and return can't be done by NEC Authorized Service Station, because of shortage of spare parts due to same model is not sold in the territory.

2) Repair and Return with Loan: (This service is limited to some Service Stations)

This service is offered to the Enduser, who cannot wait until their unit is repaired.

The customer can borrow a unit for \$200 up to 12 days. Customer then sends in inoperable unit to nearest NEC Authorized Service Station for service. In order to prevent collection problem, Enduser is required to fill in Application Sheet.

Enduser needs to confirm the availability of the Service to NEC Authorized Service Stations.

3) Loan Only:

For this service, NEC Authorized Service Station supplies the customer with a loan unit for US\$200 up to 12 days. Customer keeps the inoperable unit and when customer returns home, customer arranges to have the projector serviced in the home country.

**2. Warranty Exclusions:**

This program does not apply if the Projector's serial number has been defaced, modified or removed.

If, in the judgement of NEC Authorized Service Station or its agent the defects or failures result from any cause other than fair wear and tear or NEC neglect, or fault including the following without limitation:

- 1) Accidents, transportation, neglect, misuse, abuse, water, dust, smoke or default of or by the Customer its employees or agents or any third party;
- 2) Failure or fluctuation of electrical power, electrical circuitry, air conditioning, humidity control or other environmental conditions such as use it in smoking area;
- 3) Any fault in the attachments or associated products or components (whether or not supplied by NEC or its agents which do not form part of the Product covered by this warranty);
- 4) Any act of God, fire, flood, war, act of violence or any similar occurrence;
- 5) Any attempt by any person other than any person authorized by NEC to adjust, modify, repair, install or service the product.
- 6) Any Cross-border charges such as, duty, insurance, tax etc.

**3. Charges for Warranty Exclusions and Out of Warranty Case:**

In case faulty unit is under warranty exclusions case or under Out of Warranty period, NEC Authorized Service Station will Inform estimation of actual service cost to the Enduser with reason.

**4. Dead on Arrival (DOA):**

Enduser must take this issue up with their original supplier in the country of purchase.

NEC Authorized Service Station will repair the DOA unit as a Warranty repair, but will not exchange DOA unit with new units.

**5. Loan Service Charges and Conditions:**

Upon acceptance of this NEC Projector, Customer agrees to assume liability for this loan unit.

The current cost of use of this loan unit is \$200.00 USD for 12 calendar days.

If Customer does not return the unit within the 12 calendar days, Customer will be charged the next highest cost up to and including the full list price to Credit Cards, which price will be informed by NEC Authorized Service Stations. Please see the attached listing of contacts for each country to arrange for pickup of the loan unit.

If you return to their country of origin with the loan unit, you will be charged additional freight to return the unit to the loaning country.

Thank you for your understanding of this program.