

NEC

MultiSync EA221WM

User's Manual



Index

Warning, Caution	English-1
Registration Information	English-1
Recommended use	English-3
Contents	English-5
Quick Start	English-6
Controls	English-11
Specifications	English-14
Features	English-15
Troubleshooting	English-16
TCO'03	English-17
Manufacturer's Recycling and Energy Information	English-18

**WARNING**

TO PREVENT FIRE OR SHOCK HAZARDS, DO NOT EXPOSE THIS UNIT TO RAIN OR MOISTURE. ALSO, DO NOT USE THIS UNIT'S POLARIZED PLUG WITH AN EXTENSION CORD RECEPTACLE OR OTHER OUTLETS UNLESS THE PRONGS CAN BE FULLY INSERTED.

REFRAIN FROM OPENING THE CABINET AS THERE ARE HIGH VOLTAGE COMPONENTS INSIDE. REFER SERVICING TO QUALIFIED SERVICE PERSONNEL.

**CAUTION**

CAUTION: TO REDUCE THE RISK OF ELECTRIC SHOCK, MAKE SURE POWER CORD IS UNPLUGGED FROM WALL SOCKET. TO FULLY DISENGAGE THE POWER TO THE UNIT, PLEASE DISCONNECT THE POWER CORD FROM THE AC OUTLET. DO NOT REMOVE COVER (OR BACK). NO USER SERVICEABLE PARTS INSIDE. REFER SERVICING TO QUALIFIED SERVICE PERSONNEL.



This symbol warns user that uninsulated voltage within the unit may have sufficient magnitude to cause electric shock. Therefore, it is dangerous to make any kind of contact with any part inside this unit.



This symbol alerts the user that important literature concerning the operation and maintenance of this unit has been included. Therefore, it should be read carefully in order to avoid any problems.

CAUTION: Please use the power cord provided with this display in accordance with the table below. If a power cord is not supplied with this equipment, please contact your supplier. For all other cases, please use a power cord that matches the AC voltage of the power outlet and has been approved by and complies with the safety standard of your particular country.

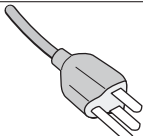
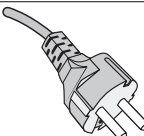
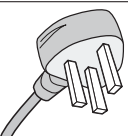
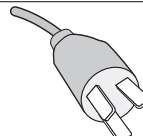
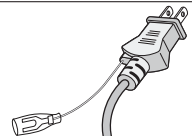
Plug Type	North America	European Continental	U.K.	Chinese	Japanese
Plug Shape					
Country	U.S.A./Canada	EU (except U.K.)	U.K.	China	Japan
Voltage	120*	230	230	220	100

*When operating the MultiSync EA221WM monitor with its AC 125-240V power supply, use a power supply cord that matches the power supply voltage of the AC power outlet being used.

NOTE: This product can only be serviced in the country where it was purchased.

Registration Information

Declaration

Declaration of the Manufacturer

We hereby certify that the colour monitor MultiSync EA221WM (L227HR) is in compliance with

Council Directive 2006/95/EC:
– EN 60950-1

Council Directive 2004/108/EC:
– EN 55022
– EN 61000-3-2
– EN 61000-3-3
– EN 55024

and marked with



NEC Display Solutions, Ltd.
4-13-23, Shibaura,
Minato-Ku
Tokyo 108-0023, Japan



Canadian Department of Communications Compliance Statement

DOC: This Class B digital apparatus meets all requirements of the Canadian Interference-Causing Equipment Regulations.
C-UL: Bears the C-UL Mark and is in compliance with Canadian Safety Regulations according to CAN/CSA C22.2 No. 60950-1.

FCC Information

1. Use the attached specified cables with the MultiSync EA221WM (L227HR) color monitor so as not to interfere with radio and television reception.

- (1) The power supply cord you use must have been approved by and comply with the safety standards of U.S.A., and meet the following condition.

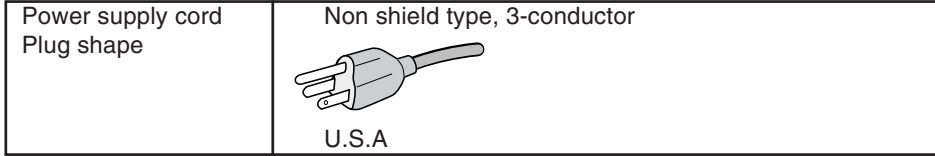

- (2) Please use the supplied shielded video signal cable, 15-pin mini D-SUB to D-SUB cable or DVI-D to DVI-D cable. Use of other cables and adapters may cause interference with radio and television reception.

2. This equipment has been tested and found to comply with the limits for a Class B digital device, pursuant to part 15 of the FCC Rules. These limits are designed to provide reasonable protection against harmful interference in a residential installation. This equipment generates, uses, and can radiate radio frequency energy, and, if not installed and used in accordance with the instructions, may cause harmful interference to radio communications. However, there is no guarantee that interference will not occur in a particular installation. If this equipment does cause harmful interference to radio or television reception, which can be determined by turning the equipment off and on, the user is encouraged to try to correct the interference by one or more of the following measures:

- Reorient or relocate the receiving antenna.
- Increase the separation between the equipment and receiver.
- Connect the equipment into an outlet on a circuit different from that to which the receiver is connected.
- Consult your dealer or an experienced radio/TV technician for help.

If necessary, the user should contact the dealer or an experienced radio/television technician for additional suggestions. The user may find the following booklet, prepared by the Federal Communications Commission, helpful: "How to Identify and Resolve Radio-TV Interference Problems." This booklet is available from the U.S. Government Printing Office, Washington, D.C., 20402, Stock No. 004-000-00345-4.

Declaration of Conformity

This device complies with Part 15 of FCC Rules. Operation is subject to the following two conditions. (1) This device may not cause harmful interference, and (2) this device must accept any interference received, including interference that may cause undesired operation.

U.S. Responsible Party:	NEC Display Solutions of America, Inc.
Address:	500 Park Blvd, Suite 1100 Itasca, Illinois 60143
Tel. No.:	(630) 467-3000

Type of Product: Display Monitor
Equipment Classification: Class B Peripheral
Models: MultiSync EA221WM (L227HR)



We hereby declare that the equipment specified above conforms to the technical standards as specified in the FCC Rules.

Windows is a registered trademark of Microsoft Corporation. NEC is a registered trademark of NEC Corporation. ENERGY STAR is a U.S. registered trademark.

ErgoDesign is a registered trademark of NEC Display Solutions, Ltd. in Austria, Benelux, Denmark, France, Germany, Italy, Norway, Spain, Sweden, U.K.

NaViSet is a trademark of NEC Display Solutions Europe GmbH in the countries of EU and Switzerland.

MultiSync is a registered trademark of NEC Display Solutions, Ltd. in the countries of U.K., Italy, Austria, Netherlands, Switzerland, Sweden, Spain, Denmark, Germany, Norway and Finland.

All other brands and product names are trademarks or registered trademarks of their respective owners.

As an ENERGY STAR® Partner, NEC Display Solutions of America, Inc. has determined that this product meets the ENERGY STAR guidelines for energy efficiency. The ENERGY STAR emblem does not represent EPA endorsement of any product or service.

Recommended use

Safety Precautions and Maintenance



FOR OPTIMUM PERFORMANCE, PLEASE NOTE
THE FOLLOWING WHEN SETTING UP AND USING
THE MULTISYNC LCD COLOUR MONITOR:



- **DO NOT OPEN THE MONITOR.** There are no user serviceable parts inside and opening or removing covers may expose you to dangerous shock hazards or other risks. Refer all servicing to qualified service personnel.
- Do not spill any liquids into the cabinet or use your monitor near water.
- Do not insert objects of any kind into the cabinet slots, as they may touch dangerous voltage points, which can be harmful or fatal or may cause electric shock, fire or equipment failure.
- Do not place any heavy objects on the power cord. Damage to the cord may cause shock or fire.
- Do not place this product on a sloping or unstable cart, stand or table, as the monitor may fall, causing serious damage to the monitor.
- The power supply cord you use must have been approved by and comply with the safety standards of your country. (Type H05VV-F 3G 0.75mm² should be used in Europe).
- In U.K, use a BS-approved power cord with molded plug having a black (5A) fuse installed for use with this monitor.
- Do not place any objects onto the monitor and do not use the monitor outdoors.
- The lamps in this product contain mercury. Please dispose according to state, local or federal law.
- Do not bend, crimp or otherwise damage the power cord.
- Do not use monitor in high temperature, humid, dusty, or oily areas.
- Do not cover vent on monitor.
- Do not touch LCD panel surface while transporting, mounting and setting. Applying pressure on the LCD panel can cause serious damage.
- To prevent damage to the LCD monitor caused by tipping over due to earthquakes or other shocks, make sure to install the monitor in a stable location and take measures to prevent falling.

Immediately unplug your monitor from the wall outlet and refer servicing to qualified service personnel under the following conditions:

- When the power supply cord or plug is damaged.
- If liquid has been spilled, or objects have fallen into the monitor.
- If the monitor has been exposed to rain or water.
- If the monitor has been dropped or the cabinet damaged.
- If the monitor does not operate normally by following operating instructions.
- If glass is broken, handle with care.
- If monitor or glass is broken, do not come in contact with the liquid crystal and handle with care.



CAUTION

- Allow adequate ventilation around the monitor so that heat can properly dissipate. Do not block ventilated openings or place the monitor near a radiator or other heat sources. Do not put anything on top of monitor.
- The power cable connector is the primary means of detaching the system from the power supply. The monitor should be installed close to a power outlet which is easily accessible.
- Handle with care when transporting. Save packaging for transporting.
- Carry the monitor holding the built-in handle and bottom frames of the monitor.
- Do not carry holding only the stand.
- **Image Persistence:** Please be aware that LCD Technology may experience a phenomenon known as Image Persistence. Image Persistence occurs when a residual or "ghost" image of a previous image remains visible on the screen. Unlike CRT monitors, LCD monitors' image persistence is not permanent, but constant images being displayed for a long period of time should be avoided. To alleviate image persistence, turn off the monitor for as long as the previous image was displayed. For example, if an image was on the monitor for one hour and a residual image remains, the monitor should be turned off for one hour to erase the image.

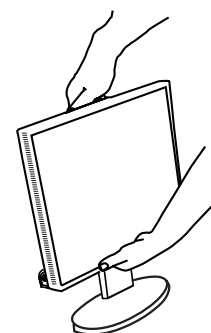

NOTE: As with all personal display devices, NEC DISPLAY SOLUTIONS recommends displaying moving images and using a moving screen saver at regular intervals whenever the screen is idle or turning off the monitor when not in use.



CORRECT PLACEMENT AND ADJUSTMENT OF THE MONITOR CAN REDUCE EYE, SHOULDER AND NECK FATIGUE. CHECK THE FOLLOWING WHEN YOU POSITION THE MONITOR:



- For optimum performance, allow 20 minutes for warm-up.
- Adjust the monitor height so that the top of the screen is at or slightly below eye level. Your eyes should look slightly downward when viewing the middle of the screen.
- Position your monitor no closer than 40 cm and no further away than 70 cm from your eyes. The optimal distance is 50 cm.
- Rest your eyes periodically by focusing on an object at least 20 feet away. Blink often.
- Position the monitor at a 90° angle to windows and other light sources to minimize glare and reflections. Adjust the monitor tilt so that ceiling lights do not reflect on your screen.
- If reflected light makes it hard for you to see your screen, use an anti-glare filter.
- Adjust the monitor's brightness and contrast controls to enhance readability.
- Use a document holder placed close to the screen.
- Position whatever you are looking at most of the time (the screen or reference material) directly in front of you to minimize turning your head while you are typing.
- Avoid displaying fixed patterns on the monitor for long periods of time to avoid image persistence (after-image effects).
- Get regular eye checkups.

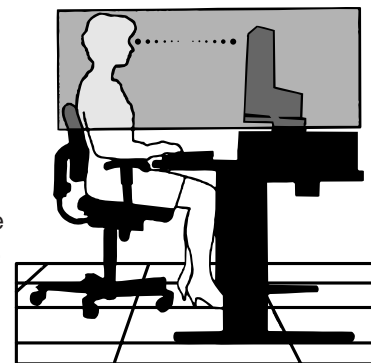

Ergonomics

To realize the maximum ergonomics benefits, we recommend the following:

- Adjust the Brightness until the background raster disappears.
- Do not position the Contrast control to its maximum setting.
- Use the preset Size and Position controls with standard signals.
- Use the preset Colour Setting.
- Use non-interlaced signals with a vertical refresh rate between 60-75 Hz.
- Do not use primary colour blue on a dark background, as it is difficult to see and may produce eye fatigue to insufficient contrast.

Cleaning the LCD Panel

- When the liquid crystal panel is stained with dust or dirt, please wipe with soft cloth gently.
- Please do not rub the LCD panel with hard material.
- Please do not apply pressure to the LCD surface.
- Please do not use OA cleaner it will cause deterioration or discolor on the LCD surface.

Cleaning the Cabinet

- Unplug the power supply
- Gently wipe the cabinet with a soft cloth
- To clean the cabinet, dampen the cloth with a neutral detergent and water, wipe the cabinet and follow with a dry cloth.

NOTE: Many plastics are used on the surface of the cabinet. DO NOT clean with benzene, thinner, alkaline detergent, alcoholic system detergent, glass cleaner, wax, polish cleaner, soap powder, or insecticide. Do not touch rubber or vinyl to the cabinet for a long time. These types of fluids and fabrics can cause the paint to deteriorate, crack or peel.

Contents

Your new NEC MultiSync LCD monitor box* should contain the following:

- MultiSync LCD monitor with tilt/swivel/pivot/height adjust stand
- Power Cord
- Cable cover
- Video Signal Cable (15-pin mini D-SUB male to 15-pin mini D-SUB male)
- Video Signal Cable (DVI-D to DVI-D)
- USB Cable
- Audio Cable
- Setup Manual

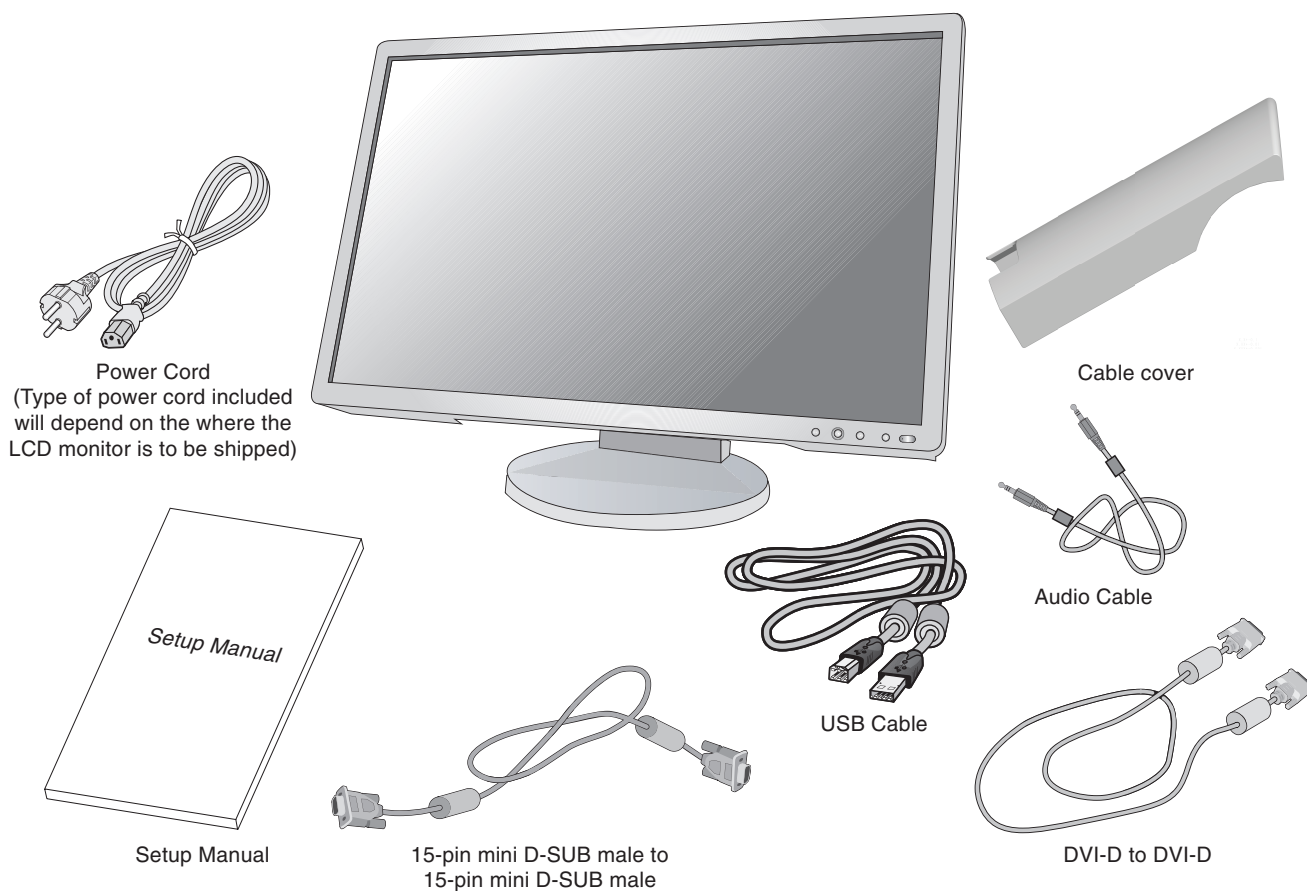

* Remember to save your original box and packing material to transport or ship the monitor.

Quick Start

To attach the MultiSync LCD monitor to your system, follow these instructions:

1. Turn off the power to your computer.
2. **For the PC or MAC with DVI digital output:** Connect the DVI signal cable to the connector of the display card in your system (**Figure A.1**). Tighten all screws.
For the PC with Analog output: Connect the 15-pin mini D-SUB signal cable to the connector of the display card in your system (**Figure A.2**). Tighten all screws.
For the MAC: Connect the Macintosh cable adapter to the computer, then attach the 15-pin mini D-SUB signal cable to the Macintosh cable adapter (**Figure B.1**). Tighten all screws.

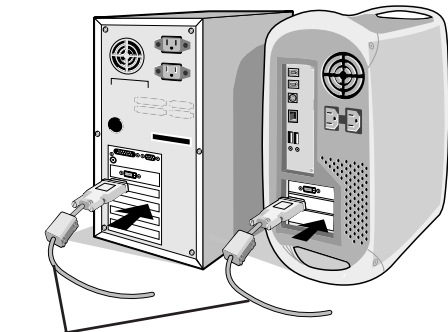

DVI signal cable
Figure A.1

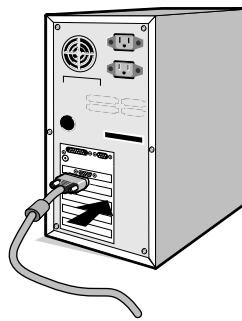
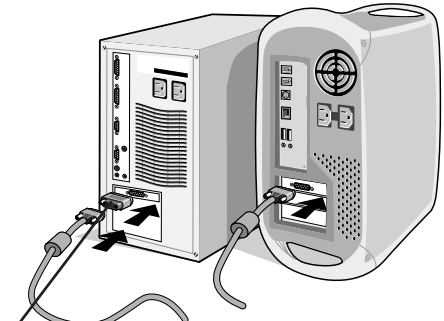

Figure A.2



Macintosh
Cable Adapter
(not included)
Figure B.1

NOTE: Some Macintosh systems do not require a Macintosh cable adapter.

3. Place hands on each side of the monitor to tilt the LCD panel 30-degree angle and lift up to the highest position (**Figure C.1**).
4. Connect all cables to the appropriate connectors (**Figure C.1**). Connect the Headphone (not included) to the appropriate connector at the left side of the monitor (**Figure C.1**). When using the USB cable, connect the B type connector to the USB upstream port on the right back side of the monitor and the A type connector to the downstream port on the computer (**Figure C.1a**). If you can use the cord from the USB device, use one of the downstream ports on the side of the monitor.

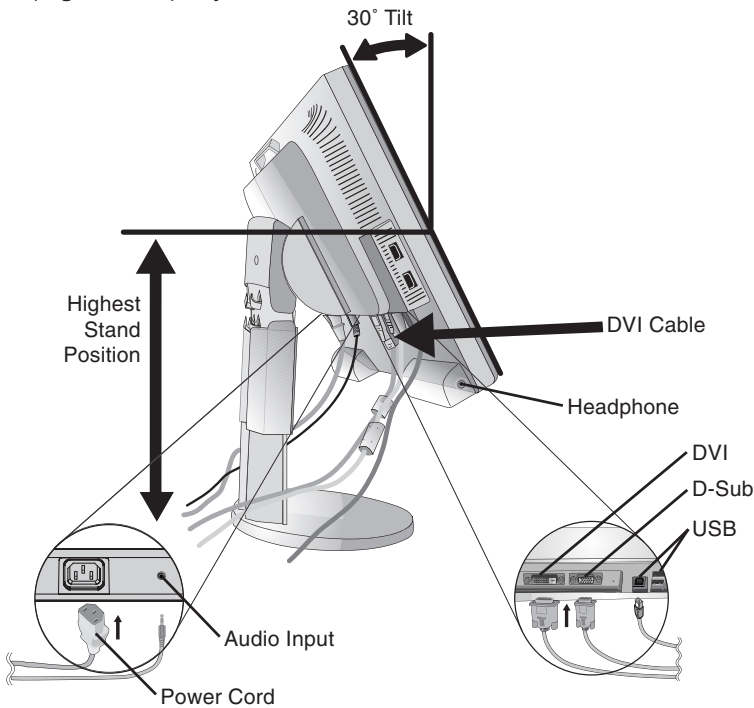

Figure C.1

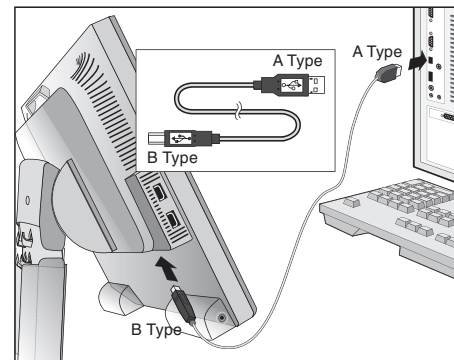

Figure C.1a

5. To keep the cables neatly organized, place them into the cable management system that is built into the stand. Place the Power cord and DVI cables into the specific hooks, as indicated in **Figure C.2/Figure C.3**. Place the D-Sub and the USB cables into the specific hooks, as indicated in **Figure C.2/Figure C.3**.
6. Make sure all cables are resting flat against the stand (**Figure C.2/Figure C.3**). Please check Tilt, Rise and Lower monitor screen and screen rotation when you manage cables.

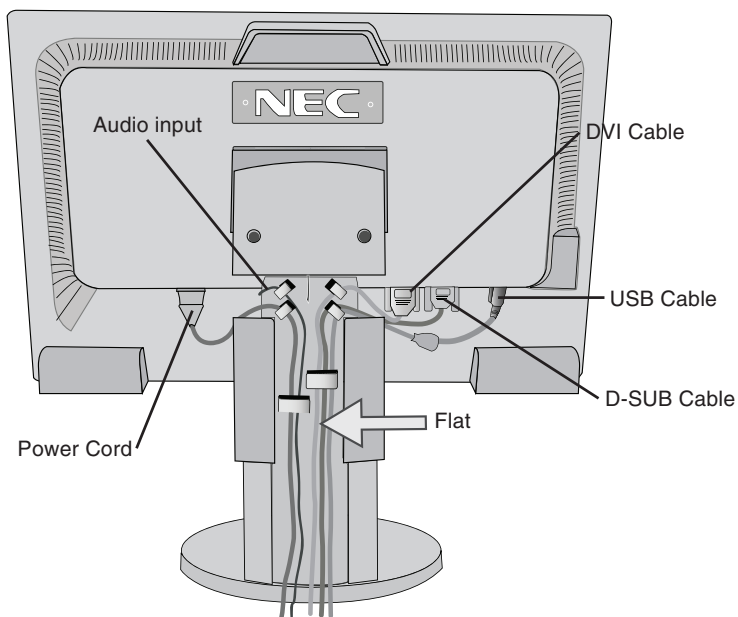

Figure C.2

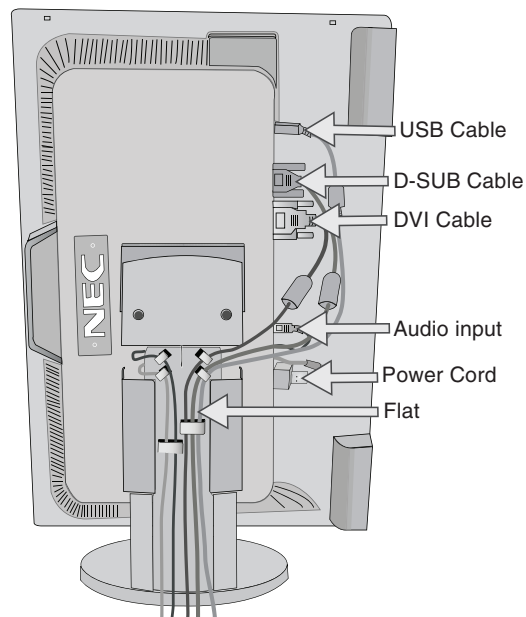

Figure C.3

7. Hold all cables firmly and place the cable cover onto the stand (**Figure D.1**). To remove the cable cover, lift the cover off as shown in **Figure D.2**.

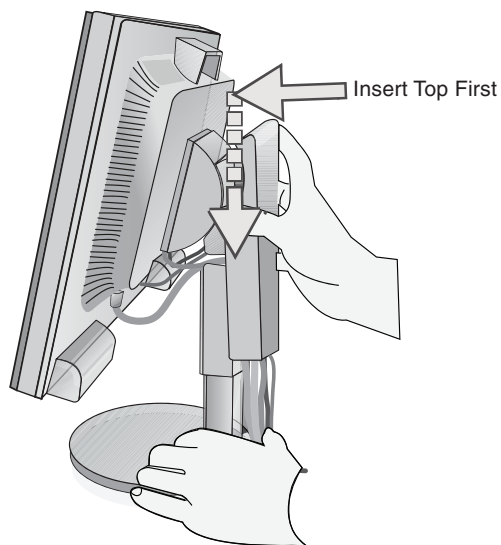

Figure D.1

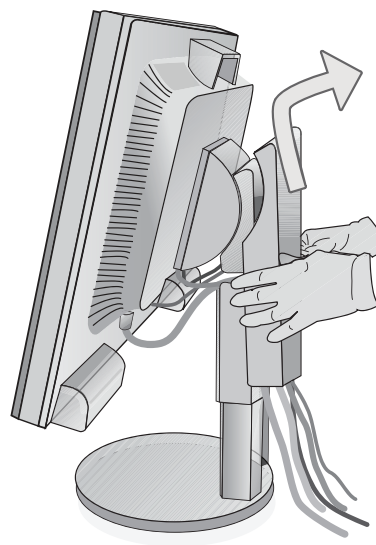

Figure D.2

8. Connect the power cord to the power outlet (**Figure E.1**).

NOTE: If you have difficulty removing the cable cover, please push the lower opening upward to remove it, as show in **Figure E.2**.

NOTE: Please refer to **Caution** section of this manual for proper selection of AC power cord.

9. Turn on the monitor with the front power button and the computer (**Figure E.1**).

10. No-Touch Auto Adjust automatically adjusts the monitor to optimal settings upon initial setup for most timings.
For further adjustments, use the following OSD controls:

- Auto Adjust Contrast (Analog input only)
- Auto Adjust (Analog input only)

Refer to the **Controls** section of this User's Manual for a full description of these OSD controls.

NOTE: If you have any problems, please refer to the **Troubleshooting** section of this User's Manual.



Figure E.1

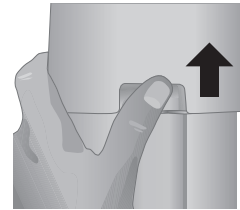

Figure E.2

Raise and Lower Monitor Screen

The monitor may be raised or lowered. To raise or lower screen, place hands on each side of the monitor and lift or lower to the desired height (**Figure RL.1**).

NOTE: Handle with care when raising or lowering the monitor screen.

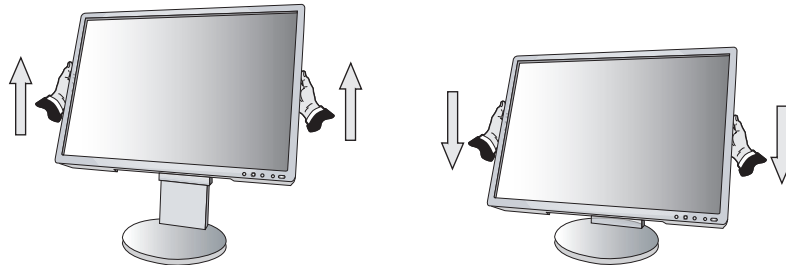

Figure RL.1

Tilt and Swivel

Grasp both sides of the monitor screen with your hands and adjust the tilt and swivel as desired (**Figure TS.1**).

NOTE: Handle with care when tilting and swivelling the monitor screen.

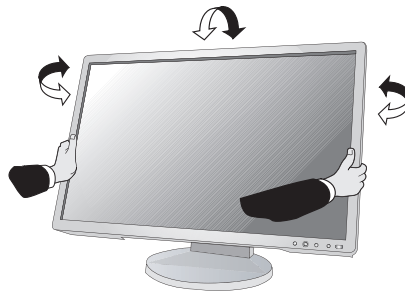

Figure TS.1

Screen Rotation

Before rotating, the screen must be raised to the highest level to avoid knocking the screen on the desk or pinching with your fingers.

To raise the screen, with one hand, grip the top of the display by the handle using the other hand to grip the bottom. Lift up to the highest position (**Figure RL.1**).

To rotate screen, place hands on each side of the monitor screen and turn clockwise from Landscape to Portrait or counter-clockwise from Portrait to Landscape (**Figure R.1**).

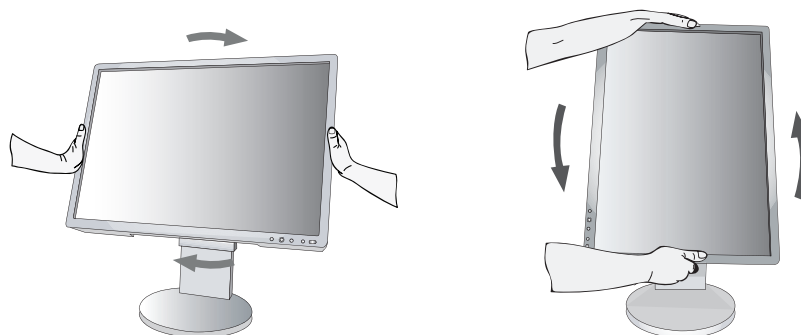

Figure R.1

Remove Monitor Stand for Mounting

To prepare the monitor for alternate mounting purposes:

1. Place hands on each side of the monitor and lift up to the highest position. Remove the cable cover (**Figure S.1**).

NOTE: If you have difficulty removing the cable cover, please push the lower opening upward to remove it, as shown in the figure beside.

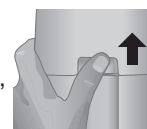

2. Disconnect all cables.
3. Place monitor face down on a non-abrasive surface (**Figure S.2**).

NOTE: Handle with care when monitor facing down, for avoiding the damage to the front buttons.

4. Remove the 4 screws connecting the stand to the monitor (**Figure S.2**).

NOTE: In order to avoid stand drop, when removing screws, please support stand with your hand.

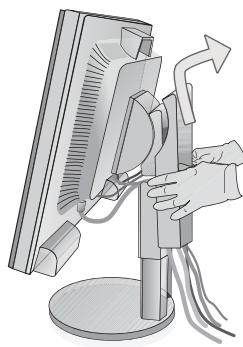

Figure S.1

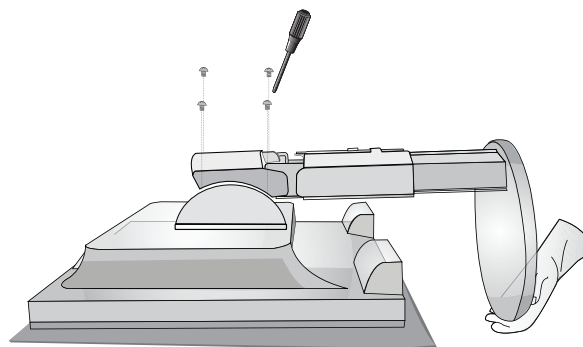

Figure S.2

5. Remove the stand (**Figure S.3**).
6. The monitor is now ready for mounting in an alternate manner.
7. Connect the cables to the back of the monitor.

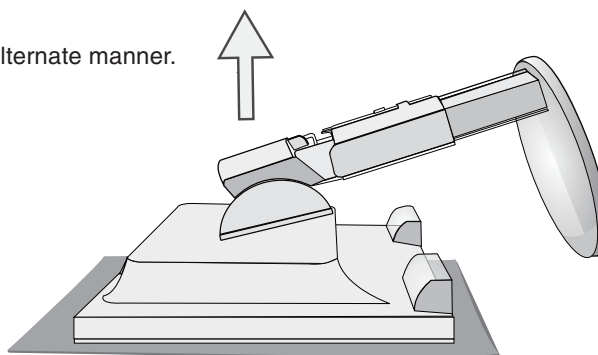
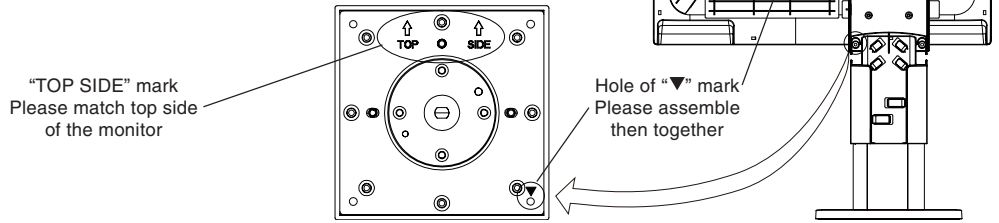

Figure S.3

8. Reverse this process to re-attach stand.

NOTE: Use only VESA-compatible alternative mounting method.
Handle with care when removing stand.

NOTE: Match "TOP SIDE" mark on stand to top side of the monitor head when re-attaching stand.



Flexible Arm Installation

This LCD monitor is designed for use with a flexible arm. To mount the monitor to a flexible arm:

1. Follow the instructions on how Remove Monitor Stand for Mounting to remove the stand.
2. Using the 4 screws from the stand removal, attach the arm to the monitor (**Figure F.1**).

NOTE: 1. When mounting, use ONLY the screws (4 pcs) that were removed from the stand to avoid damage to the monitor or stand.

2. The LCD monitor should only be used with an approved arm (e.g. GS mark). To meet the safety requirements, the monitor must be mounted to an arm, which guaranties the necessary stability under consideration of the weight of the monitor.

3. The mounting stand must be able to sustain at least 21.2 kg and be UL certified.

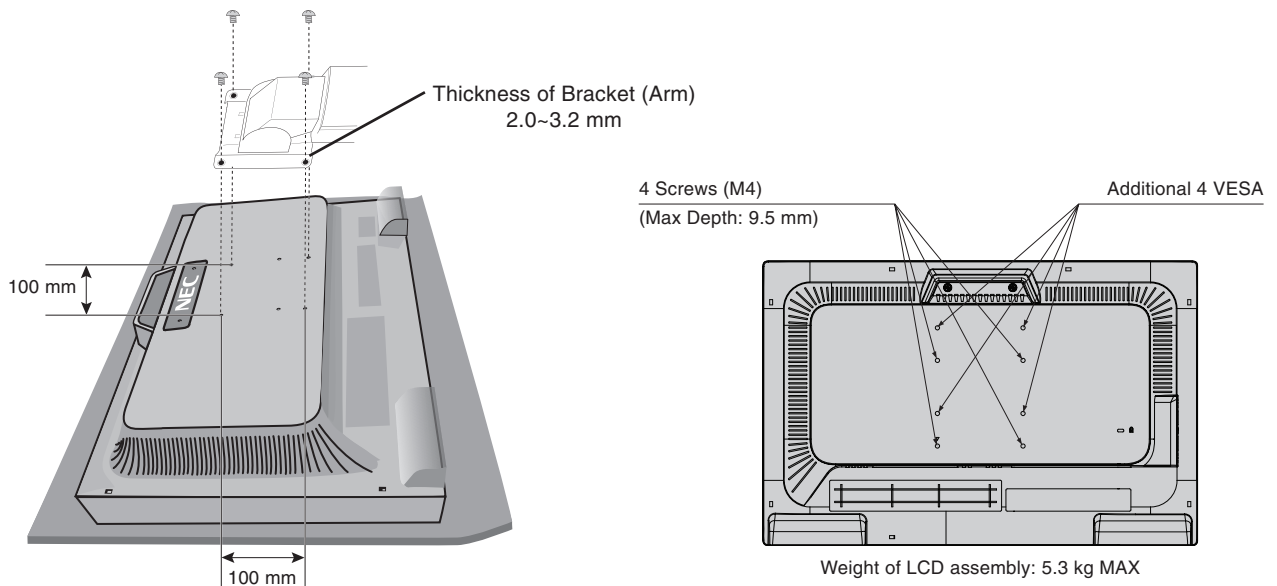

Figure F.1

An additional 4 VESA holes are provided for those users needing a lower monitor head position, than that available from the monitor stand in shipping configuration.

The monitor stand can be re-attached using the 4 screws to the lower position VESA holes.

NOTE: 1. The monitor head tilt function may have impaired operation when attached to the lower position VESA holes.
2. The monitor head pivot function should not be used when attached to the lower position VESA holes.

Controls

OSD (On-Screen Display) control buttons on the front of the monitor function as follows:

To access OSD menu, press any of the control buttons (MENU, Left, Right, Down, Up).

To change signal input, press the SELECT button.

To change DV MODE, press the RESET/DV MODE button.

NOTE: OSD must be closed in order to change signal input.



Button	Menu
MENU	Open OSD main menu. Exits the OSD controls. Exits to the OSD main menu.
4-Direction-Key	Up Left  Right Down
Left/Right	Moves the highlighted area left/right to select control menus. Moves the bar left/right to increase or decrease the adjustment. Direct adjust of brightness if HOT KEY is set to ON. Enters the OSD menu if HOT KEY is set to OFF.
Down/Up	Moves the highlighted area down/up to select one of the controls. Direct adjust of Volume if HOT KEY is set to ON. Enters the OSD menu if HOT KEY is set to OFF.
SELECT	Enter the OSD sub menu. Active the selected function. Change the Input source (No OSD condition).
RESET/DV MODE	Resets the highlighted control menu to the factory setting. Switches the DV Mode. Activates Auto Adjust function if pushed for 3 seconds (No OSD condition and Analog input only).

NOTE: When **RESET** is pressed in the main and sub-menu, a warning window will appear allowing you to cancel the **RESET** function by pressing the **MENU** button.



Brightness/Contrast Controls

BRIGHTNESS

Adjusts the overall image and background screen brightness.

If ECO MODE is set to ON, a bar for CARBON FOOTPRINT will appear.

CONTRAST

Adjusts the image brightness in relation to the background.

AUTO CONTRAST (Analog input only)

Adjusts the image displayed to optimal settings.

ECO MODE

Decreases the amount of power consumed by reducing the brightness level.

OFF: Set brightness variable from 0% to 100%.

ON: Set brightness variable range from 0% to 60%.

When this function is set to ON, a bar for CARBON FOOTPRINT appear under the brightness adjustment bar.

DV MODE

Dynamic Visual Mode allows you to select setting for Movie, Photo and etc.



Auto Adjust (Analog input only)

Automatically adjusts the Image Position, H. Size and Fine settings.



Image Controls (Analog input only)

LEFT / RIGHT

Controls Horizontal Image Position within the display area of the LCD.

DOWN / UP

Controls Vertical Image Position within the display area of the LCD.

H.SIZE

Adjusts the horizontal size by increasing or decreasing this setting.

FINE

Improves focus, clarity and image stability by increasing or decreasing this setting.



Colour Control System

Colour Control System: Six colour presets select the desired colour setting (sRGB and NATIVE colour presets are standard and cannot be changed).

R,G,B: Increases or decreases Red, Green or Blue colour depending upon which is selected. The change in colour will appear on screen and the direction (increase or decrease) will be shown by the bars.

NATIVE: Original colour presented by the LCD panel that is unadjustable.

sRGB: sRGB mode dramatically improves the colour fidelity in the desktop environment by a single standard RGB colour space. With this colour supported environment, the operator could easily and confidently communicate colour without further colour management overhead in the most common situations.

NOTE: When MOVIE, GAMING, or PHOTO is selected as the DV MODE, NATIVE is selected automatically as the six colour preset and cannot be changed.



Tools

VOLUME: Controls the volume of the speakers or headphones.

To mute the speaker output, press the "RESET/DV MODE" button.

EXPANSION: Selects the zoom mode.

FULL: The image is expanded to 1680 x 1050, regardless of the resolution.

ASPECT: The image is expanded without changing the aspect ratio.

OFF TIMER: Monitor will automatically power-down when the end user has selected a predetermined amount of time.

INPUT RESOLUTION (Analog Input Only): Selects resolution's priority of input signal to one of the following pair:

1360 x 768, 1680 x 1050 or 1280 x 768, 1680 x 1050 or 1024 x 768, 1400 x 1050.

1360 x 768, 1680 x 1050: Determines the resolution to 1360 x 768, 1680 x 1050.

1280 x 768, 1680 x 1050: Determines the resolution to 1280 x 768, 1680 x 1050.

1024 x 768, 1400 x 1050: Determines the resolution to 1024 x 768, 1400 x 1050.

DDC/CI: This function allows the DDC/CI function ON or OFF.

FACTORY PRESET: Selecting Factory Preset allows you to reset all OSD control settings back to the factory settings. Individual settings can be reset by highlighting the control to be reset and pressing the RESET button.



Menu Tools

LANGUAGE: OSD control menus are available in eight languages.

OSD LEFT/RIGHT: You can choose where you would like the OSD control image to appear horizontally on your screen.

OSD DOWN/UP: You can choose where you would like the OSD control image to appear vertically on your screen.

OSD TURN OFF: The OSD control menu will stay on as long as it is in use. In the OSD Turn Off submenu, you can select how long the monitor waits after the last touch of a button to shut off the OSD control menu.

OSD LOCK OUT: This control completely locks out access to all OSD control functions without Brightness and Contrast. When attempting to activate OSD controls while in the Lock Out mode, a screen will appear indicating the OSD controls are locked out. To activate the OSD Lock Out function, press SELECT, then right control button and hold down simultaneously. To deactivate the OSD Lock Out, press SELECT, then left control button and hold down simultaneously while in the OSD menu.

HOT KEY: You can adjust the brightness and volume directly. When this function is set to ON, you can adjust the brightness with left or right control and volume with up or down control while the OSD menu is off.



Information

The Information menu indicates the current input, display resolution, horizontal and vertical frequency, and polarity settings of the monitor. The model and serial numbers of your monitor are also indicated.

CARBON SAVINGS: Display the estimated carbon saving information in kg.

The carbon footprint factor in the carbon saving calculation is based on the OECD (2006 Edition).

OSD Warning

OSD Warning menus disappear with Exit button.

NO SIGNAL: This function gives a warning when there is no Horizontal or Vertical Sync. After power is turned on or when there is a change of input signal, the **No Signal** window will appear.

OUT OF RANGE: When input signal is non-supported timing or the video signal doesn't have proper timing, the **Out of Range** menu will appear.

Specifications

Monitor Specifications		MultiSync EA221WM	Notes
LCD Module	Diagonal: Viewable Image Size: Native Resolution (Pixel Count):	55.9 cm/22.0 inches 55.9 cm/22.0 inches 1680 x 1050	Active matrix; thin film transistor (TFT) liquid crystal display (LCD); 0.282 mm dot pitch; 250 cd/m ² white luminance; 1000:1 contrast ratio, typical.
Input Signal	Video: Sync:	ANALOG 0.7 Vp-p/75 Ohms Separate sync.TTL Horizontal sync. Positive/Negative Vertical sync. Positive/Negative Composite sync. Positive/Negative Sync on Green (Video 0.7 Vp-p and Sync Negative 0.3 Vp-p)	Digital Input: DVI-D with HDCP
Display Colours		16,777,216	Depends on display card used.
Synchronization Range	Horizontal: Vertical:	31.5 kHz to 81.1 kHz (Analog) 31.5 kHz to 81.1 kHz (Digital) 56.0 Hz to 75.0 Hz	Automatically Automatically Automatically
Viewing Angle	Left/Right: Up/Down:	±88° (CR > 5) ±85° (CR > 5)	
Resolutions Supported		720 x 400*1: VGA text 640 x 480*1 at 60 Hz to 75 Hz 800 x 600*1 at 56 Hz to 75 Hz 832 x 624*1 at 75 Hz 1024 x 768*1 at 60 Hz to 75 Hz 1152 x 864*1 at 75 Hz 1152 x 870*1 at 75 Hz 1280 x 960*1 at 60 Hz to 75 Hz 1280 x 1024*1 at 60 Hz to 75 Hz 1440 x 900*1 at 60 Hz to 75 Hz 1400 x 1050*1 at 60 Hz to 75 Hz 1680 x 1050 at 60 Hz.....	Some systems may not support all modes listed. NEC DISPLAY SOLUTIONS cites recommended resolution for optimal display performance.
Active Display Area	Landscape: Horiz.: Vert.: Portrait: Horiz.: Vert.:	473.8 mm / 18.7 inches 296.1 mm / 11.7 inches 296.1 mm / 11.7 inches 473.8 mm / 18.7 inches	
USB Hub	I/P: Port: Load Current:	USB Specification Revision 2.0 Upstream 1 Downstream 4 Maximum 0.5A per port	
Speakers	Practical Audio Output:	1.0 W + 1.0 W	
Power Supply		AC 100-240 V ~ 50/60 Hz	
Current Rating		1.00-0.55 A	
Dimensions	Landscape: Portrait: Height Adjustment:	507.8 mm (W) x 382.0 - 492.0 mm (H) x 220.0 mm (D) 20.0 inches (W) x 15.0 - 19.4 inches (H) x 8.7 inches (D) 332.1 mm (W) x 522.8 - 579.5 mm (H) x 220.0 mm (D) 13.1 inches (W) x 20.6 - 22.8 inches (H) x 8.7 inches (D) 110 mm/4.3 inches (Landscape condition) 56.7 mm/2.2 inches (Portrait condition)	
Weight		7.9 kg (17.4 lbs)	
Environmental Considerations	Operating Temperature: Humidity: Altitude: Storage Temperature: Humidity: Altitude:	5°C to 35°C / 41°F to 95°F 20% to 80% 0 to 6,562 Feet / 0 to 2,000 m -10°C to 60°C / 14°F to 140°F 10% to 85% 0 to 40,000 Feet / 0 to 12,192 m	

*1 Interpolated Resolutions: When resolutions are shown that are lower than the pixel count of the LCD module, text may appear different. This is normal and necessary for all current flat panel technologies when displaying non-native resolutions full screen. In flat panel technologies, each dot on the screen is actually one pixel, so to expand resolutions to full screen, an interpolation of the resolution must be done.

NOTE: Technical specifications are subject to change without notice.

Features

Thin-frame design creates more desktop space for you to work and play, while the flat screen's crisp, bright images and crystal-clear text deliver a comfortable viewing experience.

No Touch Auto Adjust automatically adjusts your optimal image settings upon initial power-on.

Colour Control System allows you to change between six colour settings on your display to match your personal preference.

Redesigned OSD controls allow you to quickly and easily adjust all elements of your screen image.

NaViSet software offers an expanded and intuitive graphical interface, allowing you to more easily adjust OSD display settings via mouse and keyboard.

Height adjustable stand with tilt, swivel and cable management adds flexibility to your viewing preferences.

USB 2.0 hub adds excitement to your computing by connecting you to digital cameras, scanners and more.

The flat screen's crisp, bright images and crystal-clear text deliver a comfortable viewing experience.

ErgoDesign Features: Enhance human ergonomics to improve the working environment, protect the health of the user and save money. Examples include OSD controls for quick and easy image adjustments, tilt base for preferred angle of vision, small footprint and compliance with MPRII and TCO guidelines for lower emissions.

Plug and Play: The Microsoft® solution with the Windows® operating system facilitates setup and installation by allowing the monitor to send its capabilities (such as screen size and resolutions supported) directly to your computer, automatically optimizing display performance.

IPM (Intelligent Power Manager) System: Provides innovative power-saving methods that allow the monitor to shift to a lower power consumption level when on but not in use, saving two-thirds of your monitor energy costs, reducing emissions and lowering the air conditioning costs of the workplace.

Multiple Frequency Technology: Automatically adjusts monitor to the display card's scanning frequency, thus displaying the resolution required.

FullScan Capability: Allows you to use the entire screen area in most resolutions, significantly expanding image size.

VESA Standard Mounting Interface: Allows users to connect their MultiSync monitor to any VESA standard third party mounting arm or bracket. Allows for the monitor to be mounted on a wall or an arm using any third party compliant device.

Environmental Impact: Annual typical maximum operating carbon footprint of this monitor (world-wide average) is approximately 54.2 kg (calculated by: rated wattage x 8 hours per day x 5 days a week x 45 weeks per year x Power-to-Carbon conversion factor - conversion factor is based on OECD publication of global CO2 emissions 2006 Edition). This monitor has a manufacturing carbon footprint of approximately 26.8 kg.

Note: The manufacturing and operating carbon footprints are calculated by a unique algorithm developed exclusively by NEC for its monitors.

Troubleshooting

No picture

- The signal cable should be completely connected to the display card/computer.
- The display card should be completely seated in its slot.
- Front Power Switch and computer power switch should be in the ON position.
- Check to make sure that a supported mode has been selected on the display card or system being used. (Please consult display card or system manual to change graphics mode.)
- Check the monitor and your display card with respect to compatibility and recommended settings.
- Check the signal cable connector for bent or pushed-in pins.

Power Button does not respond

- Unplug the power cord of the monitor from the AC outlet to turn off and reset the monitor.

Image Persistence

- Please be aware that LCD Technology may experience a phenomenon known as Image Persistence. Image Persistence occurs when a residual or “ghost” image of a previous image remains visible on the screen. Unlike CRT monitors, LCD monitors’ image persistence is not permanent, but constant images being displayed for a long period of time should be avoided. To alleviate image persistence, turn off the monitor for as long as the previous image was displayed. For example, if an image was on the monitor for one hour and a residual image remains, the monitor should be turned off for one hour to erase the image.

NOTE: As with all personal display devices, NEC DISPLAY SOLUTIONS recommends displaying moving images and using a moving screen saver at regular intervals whenever the screen is idle or turning off the monitor when not in use.

Image is unstable, unfocused or swimming is apparent

- Signal cable should be completely attached to the computer.
- Use the OSD Image Adjust controls to focus and adjust display by increasing or decreasing the fine total. When the display mode is changed, the OSD Image Adjust settings may need to be re-adjusted.
- Check the monitor and your display card with respect to compatibility and recommended signal timings.
- If your text is garbled, change the video mode to non-interlace and use 60Hz refresh rate.

LED on monitor is not lit (no blue or amber colour can be seen)

- Power Switch should be in the ON position and power cord should be connected.

Display image is not sized properly

- Use the OSD Image Adjust controls to increase or decrease the H. SIZE.
- Check to make sure that a supported mode has been selected on the display card or system being used. (Please consult display card or system manual to change graphics mode.)

No Video

- Make certain the computer is not in a power-saving mode (touch the keyboard or mouse).

No Sound

- Make sure the speaker cable is proper connected.
- Check to see if mute is activated.
- Check the volume in the OSD menu.

TCO Development



Congratulations!

The display you have just purchased carries the TCO'03 Displays label. This means that your display is designed, manufactured and tested according to some of the strictest quality and environmental requirements in the world. This makes for a high performance product, designed with the user in focus that also minimizes the impact on our natural environment.

Some of the features of the TCO'03 Display requirements:

Ergonomics

- Good visual ergonomics and image quality in order to improve the working environment for the user and to reduce sight and strain problems. Important parameters are luminance, contrast, resolution, reflectance, colour rendition and image stability.

Energy

- Energy-saving mode after a certain time – beneficial both for the user and the environment
- Electrical safety

Emissions

- Electromagnetic fields
- Noise emissions

Ecology

- The product must be prepared for recycling and the manufacturer must have a certified environmental management system such as EMAS or ISO 14 001.
- Restrictions on:
 - chlorinated and brominated flame retardants and polymers
 - heavy metals such as cadmium, mercury and lead.

The requirements included in this label have been developed by TCO Development in co-operation with scientists, experts, users as well as manufacturers all over the world. Since the end of the 1980s TCO has been involved in influencing the development of IT equipment in a more user-friendly direction. Our labelling system started with displays in 1992 and is now requested by users and IT-manufacturers all over the world.

For more information, please visit
www.tcodevelopment.com

Manufacturer's Recycling and Energy Information

NEC DISPLAY SOLUTIONS is strongly committed to environmental protection and sees recycling as one of the company's top priorities in trying to minimize the burden placed on the environment. We are engaged in developing environmentally-friendly products, and always strive to help define and comply with the latest independent standards from agencies such as ISO (International Organisation for Standardization) and TCO (Swedish Trades Union).

Disposing of your old NEC product

The aim of recycling is to gain an environmental benefit by means of re-use, upgrading, reconditioning or reclamation of material. Dedicated recycling sites ensure that environmentally harmful components are properly handled and securely disposed. To ensure the best recycling of our products, **NEC DISPLAY SOLUTIONS offers a variety of recycling procedures** and gives advice on how to handle the product in an environmentally sensitive way, once it has reached the end of its life.

All required information concerning the disposal of the product and country-specific information on recycling facilities can be found on our following websites:

<http://www.nec-display-solutions.com/greencompany/> (in Europe),

<http://www.nec-display.com> (in Japan) or

<http://www.necdisplay.com> (in USA).

Energy Saving

This monitor features an advanced energy saving capability. When a VESA Display Power Management Signalling (DPMS) Standard signal is sent to the monitor, the Energy Saving mode is activated. The monitor enters a single Energy Saving mode.

Mode	Power consumption	LED colour
Maximum Operation	59W	Blue
Normal Operation	39W USB/Audio sleeping	Blue
Energy Saving Mode	Less than 2W	Amber
Off Mode	Less than 1W	Unlit

WEEE Mark (European Directive 2002/96/EC)



Within the European Union

EU-wide legislation, as implemented in each Member State, requires that waste electrical and electronic products carrying the mark (left) must be disposed of separately from normal household waste. This includes monitors and electrical accessories, such as signal cables or power cords. When you need to dispose of your NEC display products, please follow the guidance of your local authority, or ask the shop where you purchased the product, or if applicable, follow any agreements made between yourself and NEC.

The mark on electrical and electronic products only applies to the current European Union Member States.

Outside the European Union

If you wish to dispose of used electrical and electronic products outside the European Union, please contact your local authority so as to comply with the correct disposal method.