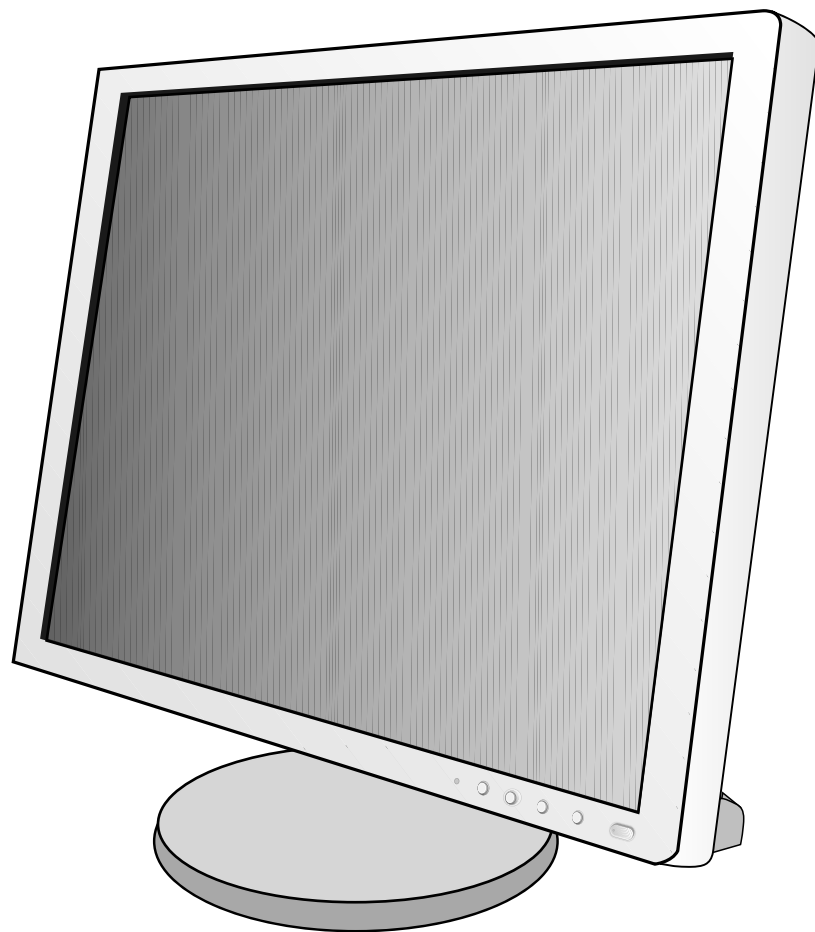


NEC

MultiSync EA192M

User's Manual



Index

Warning, Caution	English-1
Registration Information	English-1
Recommended use	English-3
Contents	English-5
Quick Start	English-6
Controls	English-10
Specifications	English-14
Features	English-15
Troubleshooting	English-16
Using the Auto Brightness function	English-17
TCO Displays 5	English-18
Manufacturer's Recycling and Energy Information	English-19



WARNING






TO PREVENT FIRE OR SHOCK HAZARDS, DO NOT EXPOSE THIS UNIT TO RAIN OR MOISTURE. ALSO, DO NOT USE THIS UNIT'S POLARIZED PLUG WITH AN EXTENSION CORD RECEPTACLE OR OTHER OUTLETS UNLESS THE PRONGS CAN BE FULLY INSERTED.

REFRAIN FROM OPENING THE CABINET AS THERE ARE HIGH VOLTAGE COMPONENTS INSIDE. REFER SERVICING TO QUALIFIED SERVICE PERSONNEL.

CAUTION

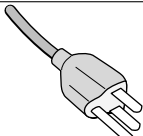
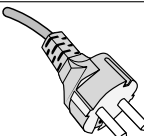
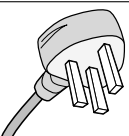
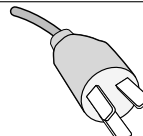
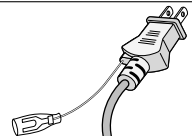
CAUTION: TO REDUCE THE RISK OF ELECTRIC SHOCK, MAKE SURE POWER CORD IS UNPLUGGED FROM WALL SOCKET. TO FULLY DISENGAGE THE POWER TO THE UNIT, PLEASE DISCONNECT THE POWER CORD FROM THE AC OUTLET. DO NOT REMOVE COVER (OR BACK). NO USER SERVICEABLE PARTS INSIDE. REFER SERVICING TO QUALIFIED SERVICE PERSONNEL.

This symbol warns user that uninsulated voltage within the unit may have sufficient magnitude to cause electric shock. Therefore, it is dangerous to make any kind of contact with any part inside this unit.

This symbol alerts the user that important literature concerning the operation and maintenance of this unit has been included. Therefore, it should be read carefully in order to avoid any problems.

CAUTION: Please use the power cord provided with this display in accordance with the table below. If a power cord is not supplied with this equipment, please contact your supplier. For all other cases, please use a power cord that matches the AC voltage of the power outlet and has been approved by and complies with the safety standard of your particular country.

Plug Type	North America	European Continental	U.K.	Chinese	Japanese
Plug Shape					
Country	U.S.A./Canada	EU (except U.K.)	U.K.	China	Japan
Voltage	120*	230	230	220	100

*When operating the MultiSync EA192M monitor with its AC 125-240V power supply, use a power supply cord that matches the power supply voltage of the AC power outlet being used.

NOTE: This product can only be serviced in the country where it was purchased.

Registration Information

Declaration

Declaration of the Manufacturer


We hereby certify that the colour monitor MultiSync EA192M (L190NY) is in compliance with

Council Directive 2006/95/EC:
– EN 60950-1

Council Directive 2004/108/EC:
– EN 55022
– EN 61000-3-2
– EN 61000-3-3
– EN 55024

Council Directive 2009/125/EC:
EC No.1275/2008
– EN 62301:2005

and marked with



NEC Display Solutions, Ltd.
4-13-23, Shibaura,
Minato-Ku
Tokyo 108-0023, Japan



Canadian Department of Communications Compliance Statement

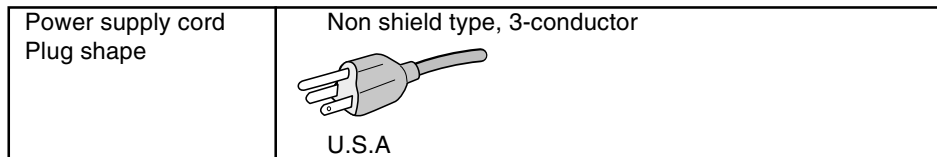
DOC: This Class B digital apparatus meets all requirements of the Canadian Interference-Causing Equipment Regulations.

C-UL: Bears the C-UL Mark and is in compliance with Canadian Safety Regulations according to CAN/CSA C22.2 No. 60950-1.

FCC Information

1. Use the attached specified cables with the MultiSync EA192M (L190NY) color monitor so as not to interfere with radio and television reception.

- (1) The power supply cord you use must have been approved by and comply with the safety standards of U.S.A., and meet the following condition.



- (2) Please use the supplied shielded video signal cable, 15-pin mini D-SUB to D-SUB cable or DVI-D to DVI-D cable. Use of other cables and adapters may cause interference with radio and television reception.

2. This equipment has been tested and found to comply with the limits for a Class B digital device, pursuant to part 15 of the FCC Rules. These limits are designed to provide reasonable protection against harmful interference in a residential installation. This equipment generates, uses, and can radiate radio frequency energy, and, if not installed and used in accordance with the instructions, may cause harmful interference to radio communications. However, there is no guarantee that interference will not occur in a particular installation. If this equipment does cause harmful interference to radio or television reception, which can be determined by turning the equipment off and on, the user is encouraged to try to correct the interference by one or more of the following measures:

- Reorient or relocate the receiving antenna.
- Increase the separation between the equipment and receiver.
- Connect the equipment into an outlet on a circuit different from that to which the receiver is connected.
- Consult your dealer or an experienced radio/TV technician for help.

If necessary, the user should contact the dealer or an experienced radio/television technician for additional suggestions. The user may find the following booklet, prepared by the Federal Communications Commission, helpful: "How to Identify and Resolve Radio-TV Interference Problems." This booklet is available from the U.S. Government Printing Office, Washington, D.C., 20402, Stock No. 004-000-00345-4.

Declaration of Conformity

This device complies with Part 15 of FCC Rules. Operation is subject to the following two conditions. (1) This device may not cause harmful interference, and (2) this device must accept any interference received, including interference that may cause undesired operation.

U.S. Responsible Party:	NEC Display Solutions of America, Inc.
Address:	500 Park Blvd, Suite 1100 Itasca, Illinois 60143
Tel. No.:	(630) 467-3000

Type of Product:	Display Monitor
Equipment Classification:	Class B Peripheral
Models:	MultiSync EA192M (L190NY)



We hereby declare that the equipment specified above conforms to the technical standards as specified in the FCC Rules.

Windows is a registered trademark of Microsoft Corporation. NEC is a registered trademark of NEC Corporation.

ENERGY STAR is a U.S. registered trademark.

ErgoDesign is a registered trademark of NEC Display Solutions, Ltd. in Austria, Benelux, Denmark, France, Germany, Italy, Norway, Spain, Sweden, U.K.

NaViSet is a trademark of NEC Display Solutions Europe GmbH in the countries of EU and Switzerland.

MultiSync is a registered trademark of NEC Display Solutions, Ltd. in the countries of U.K., Italy, Austria, Netherlands, Switzerland, Sweden, Spain, Denmark, Germany, Norway and Finland.

All other brands and product names are trademarks or registered trademarks of their respective owners.

As an ENERGY STAR® Partner, NEC Display Solutions of America, Inc. has determined that this product meets the ENERGY STAR guidelines for energy efficiency. The ENERGY STAR emblem does not represent EPA endorsement of any product or service.

DisplayPort is trademarks of Video Electronics Standards Association.



Recommended use

Safety Precautions and Maintenance



FOR OPTIMUM PERFORMANCE, PLEASE NOTE
THE FOLLOWING WHEN SETTING UP AND USING
THE MULTISYNC LCD COLOUR MONITOR:



- **DO NOT OPEN THE MONITOR.** There are no user serviceable parts inside and opening or removing covers may expose you to dangerous shock hazards or other risks. Refer all servicing to qualified service personnel.
- Do not spill any liquids into the cabinet or use your monitor near water.
- Do not insert objects of any kind into the cabinet slots, as they may touch dangerous voltage points, which can be harmful or fatal or may cause electric shock, fire or equipment failure.
- Do not place any heavy objects on the power cord. Damage to the cord may cause shock or fire.
- Do not place this product on a sloping or unstable cart, stand or table, as the monitor may fall, causing serious damage to the monitor.
- The power supply cord you use must have been approved by and comply with the safety standards of your country. (Type H05VV-F 3G 0.75mm² should be used in Europe).
- In U.K, use a BS-approved power cord with molded plug having a black (5A) fuse installed for use with this monitor.
- Do not place any objects onto the monitor and do not use the monitor outdoors.
- Do not bend, crimp or otherwise damage the power cord.
- Do not use monitor in high temperature, humid, dusty, or oily areas.
- Do not cover vent on monitor.
- Do not touch LCD panel surface while transporting, mounting and setting. Applying pressure on the LCD panel can cause serious damage.
- To prevent damage to the LCD monitor caused by tipping over due to earthquakes or other shocks, make sure to install the monitor in a stable location and take measures to prevent falling.

Immediately unplug your monitor from the wall outlet and refer servicing to qualified service personnel under the following conditions:

- When the power supply cord or plug is damaged.
- If liquid has been spilled, or objects have fallen into the monitor.
- If the monitor has been exposed to rain or water.
- If the monitor has been dropped or the cabinet damaged.
- If the monitor does not operate normally by following operating instructions.
- If glass is broken, handle with care.
- If monitor or glass is broken, do not come in contact with the liquid crystal and handle with care.
- If you notice any structural damage such as cracks or unnatural wobbling.



CAUTION

- Allow adequate ventilation around the monitor so that heat can properly dissipate. Do not block ventilated openings or place the monitor near a radiator or other heat sources. Do not put anything on top of monitor.
- The power cable connector is the primary means of detaching the system from the power supply. The monitor should be installed close to a power outlet which is easily accessible.
- Handle with care when transporting. Save packaging for transporting.
- Do not carry holding only the stand.
- **Image Persistence:** Please be aware that LCD Technology may experience a phenomenon known as Image Persistence. Image Persistence occurs when a residual or "ghost" image of a previous image remains visible on the screen. Unlike CRT monitors, LCD monitors' image persistence is not permanent, but constant images being displayed for a long period of time should be avoided. To alleviate image persistence, turn off the monitor for as long as the previous image was displayed. For example, if an image was on the monitor for one hour and a residual image remains, the monitor should be turned off for one hour to erase the image.

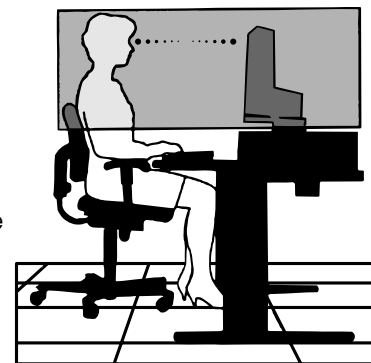
NOTE: As with all personal display devices, NEC DISPLAY SOLUTIONS recommends displaying moving images and using a moving screen saver at regular intervals whenever the screen is idle or turning off the monitor when not in use.



CORRECT PLACEMENT AND ADJUSTMENT OF THE MONITOR CAN REDUCE EYE, SHOULDER AND NECK FATIGUE. CHECK THE FOLLOWING WHEN YOU POSITION THE MONITOR:



- For optimum performance, allow 20 minutes for warm-up.
- Adjust the monitor height so that the top of the screen is at or slightly below eye level. Your eyes should look slightly downward when viewing the middle of the screen.
- Position your monitor no closer than 40 cm and no further away than 70 cm from your eyes. The optimal distance is 50 cm.
- Rest your eyes periodically by focusing on an object at least 20 feet away. Blink often.
- Position the monitor at a 90° angle to windows and other light sources to minimize glare and reflections. Adjust the monitor tilt so that ceiling lights do not reflect on your screen.
- If reflected light makes it hard for you to see your screen, use an anti-glare filter.
- Adjust the monitor's brightness and contrast controls to enhance readability.
- Use a document holder placed close to the screen.
- Position whatever you are looking at most of the time (the screen or reference material) directly in front of you to minimize turning your head while you are typing.
- Avoid displaying fixed patterns on the monitor for long periods of time to avoid image persistence (after-image effects).
- Get regular eye checkups.



Ergonomics

To realize the maximum ergonomics benefits, we recommend the following:

- Adjust the Brightness until the background raster disappears.
- Do not position the Contrast control to its maximum setting.
- Use the preset Size and Position controls with standard signals.
- Use the preset Colour Setting.
- Use non-interlaced signals with a vertical refresh rate between 60-75 Hz.
- Do not use primary colour blue on a dark background, as it is difficult to see and may produce eye fatigue to insufficient contrast.

Cleaning the LCD Panel

- When the liquid crystal panel is stained with dust or dirt, please wipe with soft cloth gently.
- Please do not rub the LCD panel with hard material.
- Please do not apply pressure to the LCD surface.
- Please do not use OA cleaner it will cause deterioration or discolor on the LCD surface.

Cleaning the Cabinet

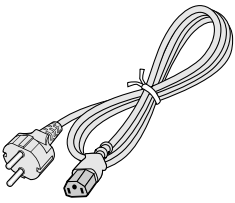
- Unplug the power supply
- Gently wipe the cabinet with a soft cloth
- To clean the cabinet, dampen the cloth with a neutral detergent and water, wipe the cabinet and follow with a dry cloth.

NOTE: Many plastics are used on the surface of the cabinet. DO NOT clean with benzene, thinner, alkaline detergent, alcoholic system detergent, glass cleaner, wax, polish cleaner, soap powder, or insecticide. Do not touch rubber or vinyl to the cabinet for a long time. These types of fluids and fabrics can cause the paint to deteriorate, crack or peel.

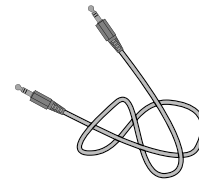
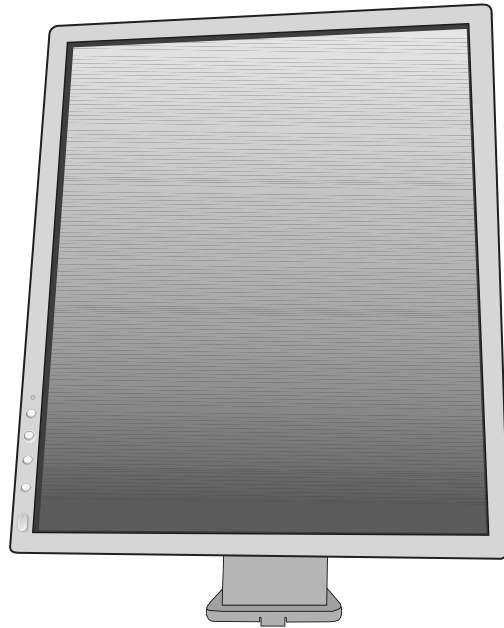
Contents

Your new NEC MultiSync LCD monitor box* should contain the following:

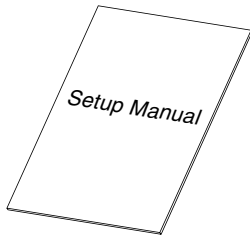
- MultiSync LCD monitor with tilt/swivel/pivot/height adjust base
- Power Cord
- Base stand
- Video Signal Cable (15-pin mini D-SUB male to 15-pin mini D-SUB male)
- Video Signal Cable (DVI-D to DVI-D)
- Audio Cable
- Setup Manual



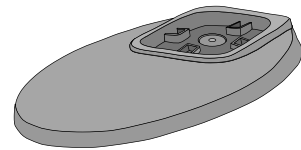
Power Cord
(Type of power cord included will depend on the where the LCD monitor is to be shipped)



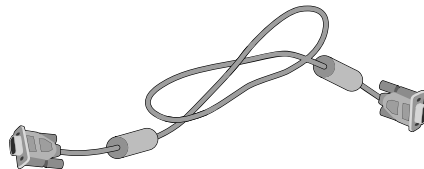
Audio Cable



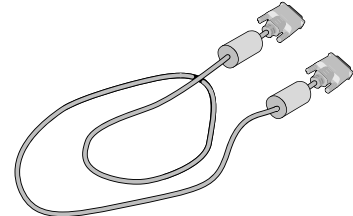
Setup Manual



Base stand



15-pin mini D-SUB male to
15-pin mini D-SUB male



DVI-D to DVI-D

* Remember to save your original box and packing material to transport or ship the monitor.

Quick Start

To attach the Base to the LCD stand:

1. Place monitor face down on a non-abrasive surface (**Figure 1**).

NOTE: Handle with care when monitor facing down, for avoiding damage to the front control buttons.

2. Please pivot base 90 degrees as shown in **Figure 1**.

NOTE: Handle with care when pulling the stand.

3. Attach the base stand to LCD monitor and properly lock screw of base stand bottom (**Figure 2**).

NOTE: Reverse this procedure if you need to re-pack the monitor.

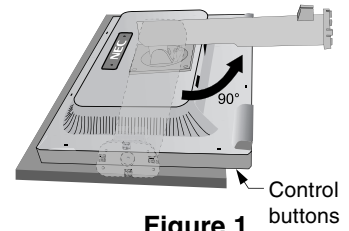


Figure 1

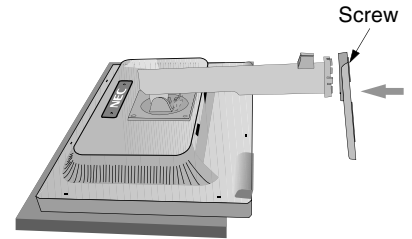


Figure 2

To attach the MultiSync LCD monitor to your system, follow these instructions:

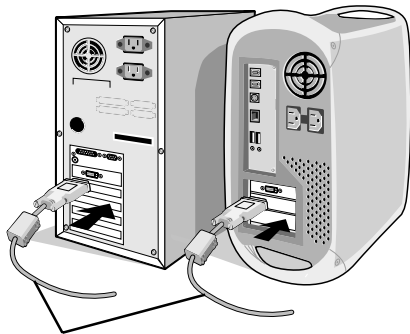
1. Turn off the power to your computer.

2. **For the PC or MAC with DVI digital output:** Connect the DVI signal cable to the connector of the display card in your system (**Figure A.1**). Tighten all screws.

For the PC with Analog output: Connect the 15-pin mini D-SUB signal cable to the connector of the display card in your system (**Figure A.2**). Tighten all screws.

For the MAC: Connect the Macintosh cable adapter to the computer, then attach the 15-pin mini D-SUB signal cable to the Macintosh cable adapter (**Figure A.3**). Tighten all screws.

For the PC with DisplayPort output: Connect the DisplayPort cable to the connector of the display card in your system (**Figure A.4**).

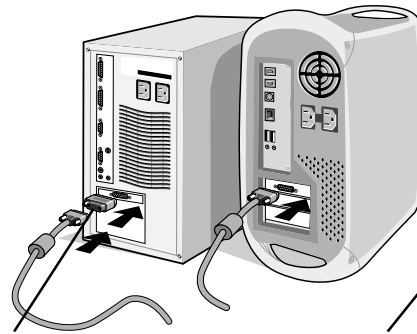


DVI signal cable

Figure A.1

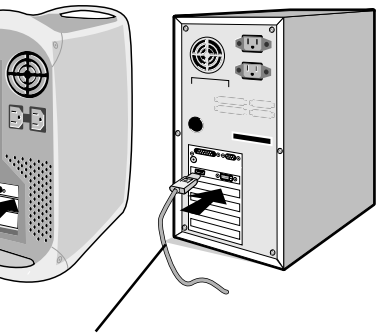


Figure A.2



Macintosh Cable Adapter (not included)

Figure A.3



DisplayPort cable (not included)

Figure A.4

NOTE: Some Macintosh systems do not require a Macintosh cable adapter.

3. Place hands on each side of the monitor to tilt the LCD panel 20-degree angle and lift up to the highest position (**Figure B.1**).

4. Connect all cables to the appropriate connector on the back of the monitor (**Figure B.1**). Connect the Headphone (not included) to the appropriate connector at the left side of the monitor (**Figure B.1**).

5. Position the Video Signal Cable and power cord between the holes on the Stand, as indicated in **Figure B.2/Figure B.3**.

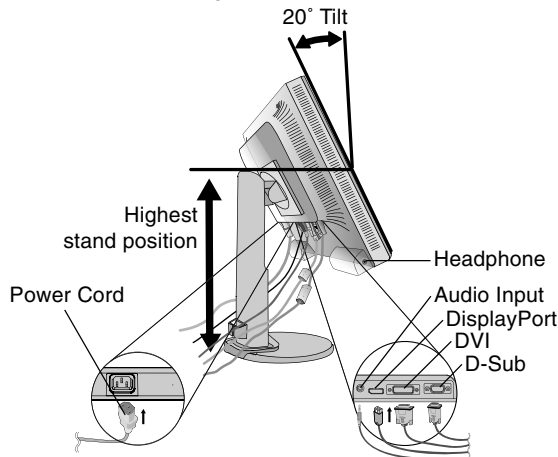


Figure B.1

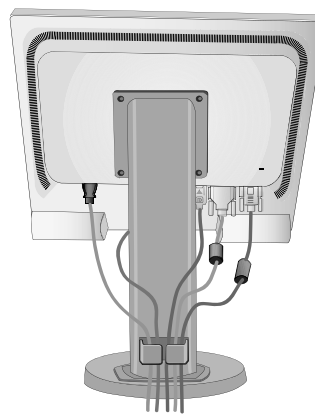


Figure B.2

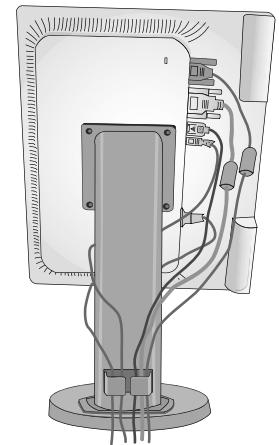


Figure B.3

- NOTE:**
1. Please use a DisplayPort cable with a DisplayPort logo.
 2. The DisplayPort connector does not supply power to the connected component.
 3. When removing the DisplayPort cable, hold down the top button to release the lock.

6. Connect the power cord to the power outlet (**Figure C.1**).

NOTE: Please refer to **Caution** section of this manual for proper selection of AC power cord.

7. Turn on the monitor with the front power button and the computer (**Figure C.1**).

8. No-Touch Auto Adjust automatically adjusts the monitor to optimal settings upon initial setup for most timings. For further adjustments, use the following OSD controls:

- Auto Adjust Contrast (Analog input only)
- Auto Adjust (Analog input only)

Refer to the **Controls** section of this User's Manual for a full description of these OSD controls.

NOTE: If you have any problems, please refer to the **Troubleshooting** section of this User's Manual.

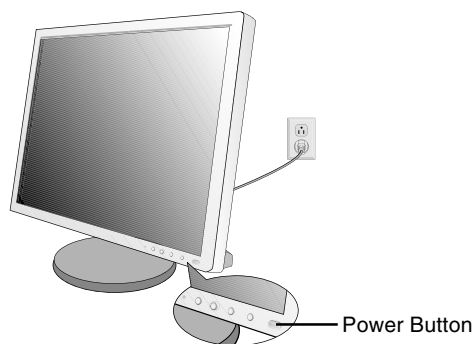


Figure C.1

Raise and Lower Monitor Screen

The monitor may be raised or lowered. To raise or lower screen, place hands on each side of the monitor and lift or lower to the desired height (**Figure RL.1**).

NOTE: Handle with care when raising or lowering the monitor screen.

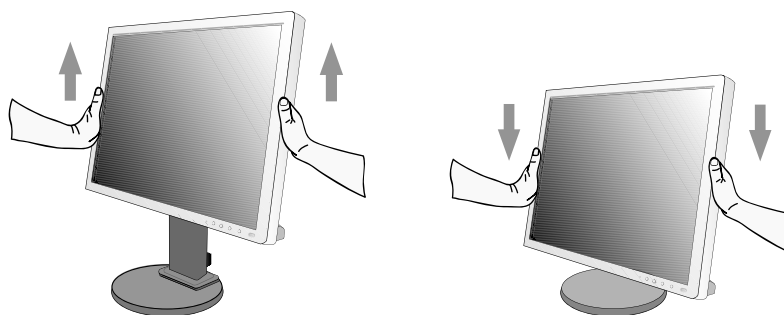


Figure RL.1

Tilt and Swivel

Grasp both sides of the monitor screen with your hands and adjust the tilt and swivel as desired (**Figure TS.1**).

NOTE: Handle with care when tilting the monitor screen.

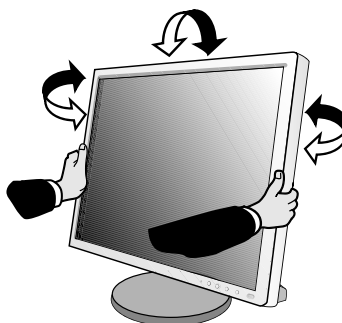


Figure TS.1

Screen Rotation

Before rotating, the screen must be raised to the highest level to avoid knocking the screen on the desk or pinching with your fingers.

To raise the screen, with one hand, grip the top of the display by the handle using the other hand to grip the bottom. Lift up to the highest position (**Figure RL.1**).

To rotate screen, place hands on each side of the monitor screen and turn clockwise from Landscape to Portrait or counter-clockwise from Portrait to Landscape (**Figure R.1**).

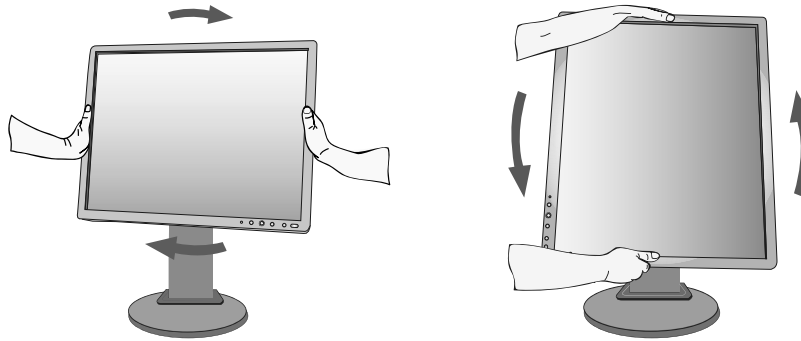


Figure R.1

Remove Monitor Stand for Mounting

To prepare the monitor for alternate mounting purposes:

1. Disconnect all cables.
2. Place monitor face down on a non-abrasive surface (**Figure S.1**).

NOTE: Handle with care when monitor facing down, for avoiding damage to the front control buttons.

3. Remove the 4 screws connecting the stand to the monitor (**Figure S.1**).

NOTE: In order to avoid stand drop, when removing screws, please support stand with your hand.

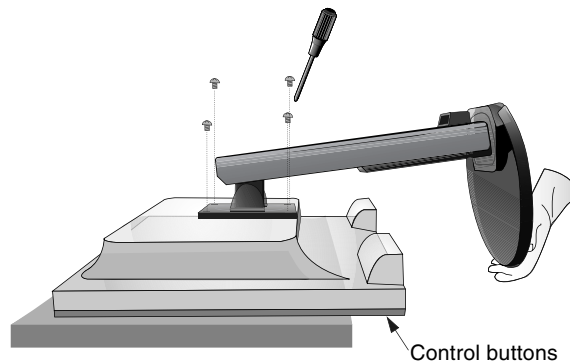


Figure S.1

4. Remove the stand (**Figure S.2**).
5. The monitor is now ready for mounting in an alternate manner.
6. Connect the cables to the back of the monitor.

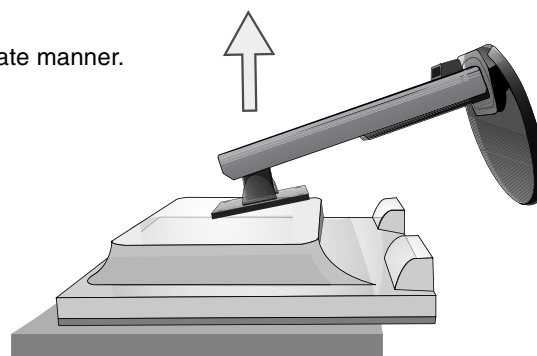
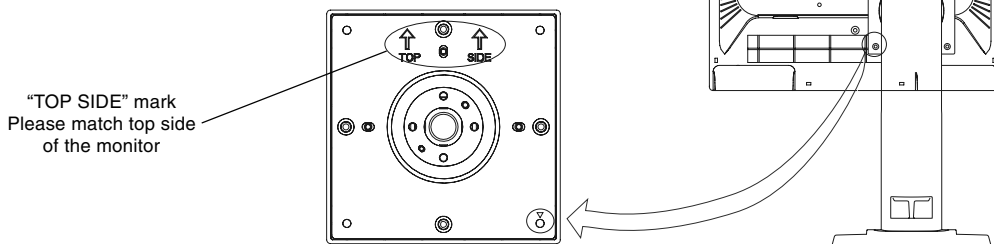


Figure S.2

7. Reverse this process to re-attach stand.

NOTE: Use only VESA-compatible alternative mounting method. Handle with care when removing stand.

NOTE: Match "TOP SIDE" mark on stand to top side of the monitor head when re-attaching stand.



Flexible Arm Installation

This LCD monitor is designed for use with a flexible arm. To mount the monitor to a flexible arm:

1. Follow the instructions on how Remove Monitor Stand for Mounting to remove the stand.
2. Using the 4 screws from the stand removal, attach the arm to the monitor (**Figure F.1**).

NOTE: 1. When mounting, use ONLY the screws (4 pcs) that were removed from the stand to avoid damage to the monitor or stand.

2. The LCD monitor should only be used with an approved arm (e.g. GS mark). To meet the safety requirements, the monitor must be mounted to an arm, which guaranties the necessary stability under consideration of the weight of the monitor.

3. The mounting stand must be able to sustain at least 14 kg and be UL certified.

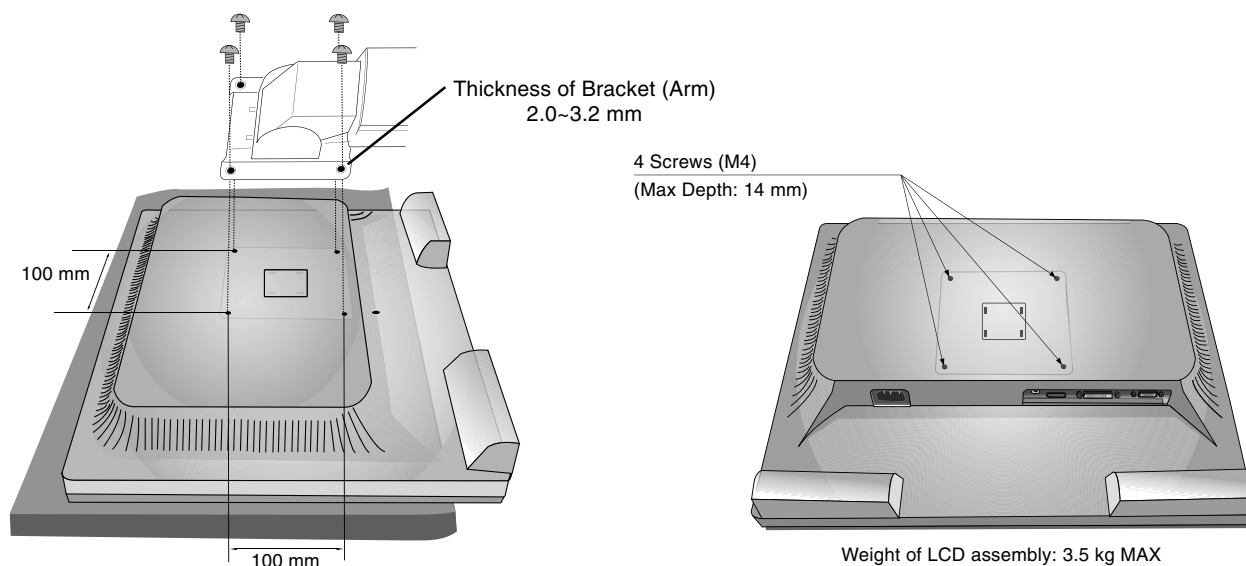


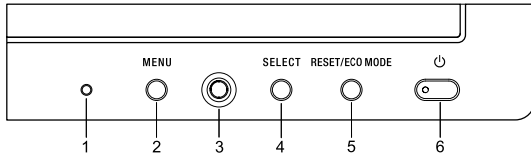
Figure F.1

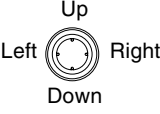
Controls

OSD (On-Screen Display) control buttons on the front of the monitor function as follows:

To access OSD menu, press any of the control buttons (MENU, Left, Right, Down, Up).
 To change signal input, press the SELECT button.
 To change ECO MODE, press the RESET/ECO MODE button.

NOTE: OSD must be closed in order to change signal input.



Button	Menu
1 Ambibright Sensor	Detects the level of ambient lighting allowing the monitor to make adjustments to various settings resulting in a more comfortable viewing experience. Do not cover this sensor.
2 MENU	Open OSD main menu. Exits the OSD controls. Exits to the OSD main menu.
3 4-Direction-Key 	Left/Right Moves the highlighted area left/right to select control menus. Moves the bar left/right to increase or decrease the adjustment. Direct adjust of BRIGHTNESS if HOT KEY is set to ON. Enters the OSD menu if HOT KEY is set to OFF.
	Down/Up Moves the highlighted area down/up to select one of the controls. Direct adjust of CONTRAST if HOT KEY is set to ON. Enters the OSD menu if HOT KEY is set to OFF.
4 SELECT	Enter the OSD sub menu. Active the selected function. Change the Input source (No OSD condition).
5 RESET/ECO MODE	Resets the highlighted control menu to the factory setting. Switches the ECO MODE. Activates Auto Adjust function if pushed for 3 seconds (No OSD condition and Analog input only).
6 Power	Turns the monitor on and off.

NOTE: When **RESET** is pressed in the main and sub-menu, a warning window will appear allowing you to cancel the **RESET** function by pressing the **MENU** button.

Brightness/Contrast Controls

BRIGHTNESS

Adjusts the overall image and background screen brightness.
 If ECO MODE is set to ON, a bar for CARBON FOOTPRINT will appear.

CONTRAST

Adjusts the image brightness in relation to the background.

AUTO CONTRAST (Analog input only)

Adjusts the image displayed to optimal settings.

ECO MODE

Decreases the amount of power consumed by reducing the brightness level.

OFF: Set brightness variable from 0% to 100%.

(ECO MODE) 1: Set brightness variable range from 0% to 80%.

This setting can adjust brightness within the range that power has reduced meeting Energy Star measurement condition.

(ECO MODE) 2: Set brightness variable range from 0% to 30%.

This setting can adjust brightness within the range that power has reduced 30% from maximum brightness setting.

When this function is set to ON, a bar for CARBON FOOTPRINT appear under the brightness adjustment bar.

NOTE: This function can't work when DV mode is set for Dynamic.

AUTO BRIGHTNESS

OFF: No function.

(AUTO BRIGHTNESS) 1: Automatically adjusts the brightness to the optimal setting by detecting the brightness level of the environment*1.

(AUTO BRIGHTNESS) 2: Automatically adjusts the brightness to the optimal brightness setting based on the white display area.

The environmental brightness sensor (Ambibright sensor) has no function.

(AUTO BRIGHTNESS) 3: Automatically adjusts the brightness to the optimal setting based on the white display area and by using the AmbiBright sensor to detect the brightness level of the environment.

*1: Please refer to Page 17 for full "Auto Brightness" information.

NOTE: This function is disabled when DV mode is set for Dynamic.

DV MODE

Dynamic Visual Mode allows you to select setting for Movie, Photo, Dynamic and etc.

STANDARD: Standard setting.

TEXT: Setting that makes letters and lines crisp, best suited for regular word processing and spread sheet.

MOVIE: Setting that boosts dark tones, best suited for movies.

GAMING: Setting that boosts whole tones, best suited for games that provide images with more power.

PHOTO: Setting that gives contrast, best suited for natural images and still images.

DYNAMIC: Setting that makes brightness dark by detecting black area. It gives high contrast.



Auto Adjust (Analog input only)

Automatically adjusts the Image Position, H. Size and Fine settings.



Image Controls (Analog input only)

LEFT / RIGHT

Controls Horizontal Image Position within the display area of the LCD.

DOWN / UP

Controls Vertical Image Position within the display area of the LCD.

H.SIZE

Adjusts the horizontal size by increasing or decreasing this setting.

FINE

Improves focus, clarity and image stability by increasing or decreasing this setting.



Colour Control System

Colour Control System: Six colour presets select the desired colour setting (sRGB and NATIVE colour presets are standard and cannot be changed).

1, 2, 3, 5: Increases or decreases Red, Green or Blue colour depending upon which is selected. The change in colour will appear on screen and the direction (increase or decrease) will be shown by the bars.

NATIVE: Original colour presented by the LCD panel that is unadjustable.

sRGB: sRGB mode dramatically improves the colour fidelity in the desktop environment by a single standard RGB colour space. With this colour supported environment, the operator could easily and confidently communicate colour without further colour management overhead in the most common situations.

NOTE: When MOVIE, GAMING, or PHOTO is selected as the DV MODE, NATIVE is selected automatically as the six colour preset and cannot be changed.



Tools

VOLUME: Controls the volume of the speakers or headphones.

To mute the speaker output, press the “RESET/ECO MODE” button.

SOUND INPUT (DisplayPort only): This function selects Audio Input or DisplayPort.

VIDEO DETECT: Selects the method of video detection when more than one computer is connected.

FIRST: The video input has to be switched to “FIRST” mode. When current video input signal is not present, then the monitor searches for a video signal from the other video input port. If the video signal is present in the other port, then the monitor switches the video source input port to the new found video source automatically. The monitor will not look for other video signals while the current video source is present.

NONE: The Monitor will not search the other video input port unless the monitor is turned on.

OFF TIMER: Monitor will automatically power-down when the end user has selected a predetermined amount of time.

LED BRIGHTNESS: You can adjust the Blue LED brightness.

DDC/CI: This function allows the DDC/CI function ON or OFF.

FACTORY PRESET: Selecting Factory Preset allows you to reset all OSD control settings back to the factory settings. Individual settings can be reset by pressing the RESET/ECO MODE button.



Menu Tools

LANGUAGE: OSD control menus are available in eight languages.

OSD LEFT/RIGHT: You can choose where you would like the OSD control image to appear horizontally on your screen.

OSD DOWN/UP: You can choose where you would like the OSD control image to appear vertically on your screen.

OSD TURN OFF: The OSD control menu will stay on as long as it is in use. In the OSD Turn Off submenu, you can select how long the monitor waits after the last touch of a button to shut off the OSD control menu.

OSD LOCK OUT: This control completely locks out access to all OSD control functions without Brightness and Contrast. When attempting to activate OSD controls while in the Lock Out mode, a screen will appear indicating the OSD controls are locked out. To activate the OSD Lock Out function, press SELECT, then right control button and hold down simultaneously. To deactivate the OSD Lock Out, press SELECT, then left control button and hold down simultaneously while in the OSD menu.

HOT KEY: You can adjust the brightness and contrast directly. When this function is set to ON, you can adjust the brightness with left or right control and contrast with up or down control while the OSD menu is off.

SIGNAL INFORMATION: If you select “ON”, monitor displays “VIDEO INPUT MENU” after change Input-Port. If you select “OFF”, monitor doesn’t display “VIDEO INPUT MENU” after change Input-Port.

IPM SETTING: The Intelligent Power Manager allows the monitor to enter into a power saving mode after a period of inactivity. The IPM has two settings:

STANDARD: Monitor enters power save mode automatically when the input signal is lost.

SENSOR: Monitor enters power save mode automatically when the amount of surrounding light goes below the level determined by you. The level can be adjusted in IPM sensor setting.

When in power save mode, the LED on the front of the monitor becomes dark blue. When in power save mode, push any of the front buttons, except for POWER and SELECT, to return to normal.

When the amount of surrounding light returns to normal levels, the monitor will automatically return to normal mode.

IPM SENSOR SETTING: Adjusts threshold level of sensor for detected dark condition and shows current sensor measurement result below.



ECO Information

CARBON SAVINGS: Displays the estimated carbon savings information in kg.

COST: Displays the electricity cost savings in balance.

CARBON CONVERT SETTING: Adjusts the carbon footprint factor in the carbon saving calculation. This initial setting is based on the OECD (2008 Edition).

CURRENCY SETTING: Displays electricity pricing (available in 6 currency units).

CURRENCY CONVERT SETTING: Allows for localization of the electricity costs for accurate information in the electrical rate savings.

NOTE: This model's initial setting is Currency = US\$ and its Currency Convert setting = \$0.11.

This setting can be changed by using the ECO information menu.

If you want to use the French setting, please refer to steps below:

1. Open menu by pressing the Menu button and select the ECO information menu using the left or right key.
2. Select Currency setting item pressing the Up or Down key.
3. The French currency unit is Euro (€). You can adjust currency setting to Euro icon (€) from US dollar icon (\$) using the Left or Right key in Current setting item.
4. Select Currency Convert Setting item using the Up or Down key*.
5. Adjust Currency Convert Setting item using the Right or Left key.

* This initial Euro (€) setting is Germany of OECD (2007 Edition).

Please check receipt of French's electricity prices or OECD data for French. French of OECD (2007 Edition) was €0.12.



Information

The Information menu indicates the current input, display resolution, horizontal and vertical frequency, and polarity settings of the monitor. The model and serial numbers of your monitor are also indicated.

OSD Warning

OSD Warning menus disappear with Exit button.

NO SIGNAL: This function gives a warning when there is no Horizontal or Vertical Sync. After power is turned on or when there is a change of input signal, the **No Signal** window will appear.

OUT OF RANGE: When input signal is non-supported timing or the video signal doesn't have proper timing, the **Out of Range** menu will appear.

Specifications

Monitor Specifications		MultiSync EA192M	Notes
LCD Module	Diagonal: Viewable Image Size: Native Resolution (Pixel Count):	48.2 cm/19.0 inches 48.2 cm/19.0 inches 1280 x 1024	Active matrix; thin film transistor (TFT) liquid crystal display (LCD); 0.294 mm dot pitch; 250 cd/m ² white luminance; 1000:1 contrast ratio, typical (25000:1 Contrast ratio, Dynamic).
Input Signal			
DVI:	DVI-D 24pin:	Digital RGB	DVI-D with HDCP
DisplayPort:	DisplayPort Connector:	Digital RGB	DisplayPort Complies with Standard V1.1a, applicable to HDCP
VGA:	15pin Mini D-sub:	Analog RGB 0.7 Vp-p/75 ohm Separate sync.TTL level Positive/Negative Composite sync.TTL level Positive/Negative Sync on Green (Video 0.7 Vp-p and Sync Negative 0.3 Vp-p)	
Display Colours		16,777,216	Depends on display card used.
Synchronization Range	Horizontal: Vertical:	31.5 kHz to 81.1 kHz (Analog) 31.5 kHz to 81.1 kHz (Digital) 56.0 Hz to 75.0 Hz	Automatically Automatically Automatically
Viewing Angle	Left/Right: Up/Down:	±85° (CR > 10) 75°/85° (CR > 10)	
Resolutions Supported		720 x 400*1: VGA text 640 x 480*1 @ 60 Hz to 75 Hz 800 x 600*1 @ 56 Hz to 75 Hz 832 x 624*1 @ 75 Hz 1024 x 768*1 @ 60 Hz to 75 Hz 1152 x 864*1 @ 75 Hz 1152 x 870*1 @ 75 Hz 1280 x 960*1 @ 60 Hz to 75 Hz 1280 x 1024*1 @ 60 Hz to 75 Hz.....	Some systems may not support all modes listed. NEC DISPLAY SOLUTIONS cites recommended resolution for optimal display performance.
Active Display Area	Landscape: Horiz.: Vert.: Portrait: Horiz.: Vert.:	376.3 mm/14.8 inches 301.1 mm/11.9 inches 301.1 mm/11.9 inches 376.3 mm/14.8 inches	
AUDIO			
AUDIO Input:	STEREO Mini Jack: DisplayPort Connector:	Analog Audio Digital Audio	Stereo L/R 500mV rms PCM 2ch 32, 44.1, 48 KHz (16/20/24bit)
Headphone Output:	STEREO Mini Jack:		Headphone Impedance 32 Ohm
Speakers	Practical Audio Output:	1.0 W + 1.0 W	
Power Supply		AC 100-240 V ~ 50/60 Hz	
Current Rating		0.60-0.35 A (with Audio)	
Power Consumption	Maximun Operation: Normal Operation:	32 W 23 W	
Dimensions	Landscape: Portrait: Height Adjustment:	408.0 mm (W) x 386.4 - 496.4 mm (H) x 213.9 mm (D) 16.1 inches (W) x 15.2 - 19.5 inches (H) x 8.4 inches (D) 338.0 mm (W) x 424.7 - 532.4 mm (H) x 213.9 mm (D) 13.3 inches (W) x 16.7 - 21.0 inches (H) x 8.4 inches (D) 110 mm/4.3 inches (Landscape condition) 107.7 mm/4.2 inches (Portrait condition)	
Weight		5.5 kg (12.1 lbs)	
Environmental Considerations			
	Operating Temperature: Humidity: Altitude:	5°C to 35°C/41°F to 95°F 20% to 80% 0 to 6,562 Feet/0 to 2,000 m	
	Storage Temperature: Humidity: Altitude:	-10°C to 60°C/14°F to 140°F 10% to 85% 0 to 40,000 Feet/0 to 12,192 m	

*1 Interpolated Resolutions: When resolutions are shown that are lower than the pixel count of the LCD module, text may appear different. This is normal and necessary for all current flat panel technologies when displaying non-native resolutions full screen. In flat panel technologies, each dot on the screen is actually one pixel, so to expand resolutions to full screen, an interpolation of the resolution must be done.

NOTE: Technical specifications are subject to change without notice.

Features

Thin-frame design creates more desktop space for you to work and play, while the flat screen's crisp, bright images and crystal-clear text deliver a comfortable viewing experience.

No Touch Auto Adjust automatically adjusts your optimal image settings upon initial power-on.

Colour Control System allows you to change between six colour settings on your display to match your personal preference.

Redesigned OSD controls allow you to quickly and easily adjust all elements of your screen image.

NaViSet software offers an expanded and intuitive graphical interface, allowing you to more easily adjust OSD display settings via mouse and keyboard.

Height-adjustable (110 mm) stand with tilt, swivel, pivot and cable management adds flexibility to your viewing preferences.

The flat screen's crisp, bright images and crystal-clear text deliver a comfortable viewing experience.

ErgoDesign Features: Enhance human ergonomics to improve the working environment, protect the health of the user and save money. Examples include OSD controls for quick and easy image adjustments, tilt base for preferred angle of vision, small footprint and compliance with MPRII and TCO guidelines for lower emissions.

Plug and Play: The Microsoft® solution with the Windows® operating system facilitates setup and installation by allowing the monitor to send its capabilities (such as screen size and resolutions supported) directly to your computer, automatically optimizing display performance.

IPM (Intelligent Power Manager) System: Provides innovative power-saving methods that allow the monitor to shift to a lower power consumption level when on but not in use, saving two-thirds of your monitor energy costs, reducing emissions and lowering the air conditioning costs of the workplace.

Multiple Frequency Technology: Automatically adjusts monitor to the display card's scanning frequency, thus displaying the resolution required.

FullScan Capability: Allows you to use the entire screen area in most resolutions, significantly expanding image size.

VESA Standard Mounting Interface: Allows users to connect their MultiSync monitor to any VESA standard third party mounting arm or bracket. Allows for the monitor to be mounted on a wall or an arm using any third party compliant device.

Environmental Impact: Annual typical maximum operating carbon footprint of this monitor (world-wide average) is approximately 29.5 kg (calculated by: rated wattage x 8 hours per day x 5 days a week x 45 weeks per year x Power-to-Carbon conversion factor - conversion factor is based on OECD publication of global CO2 emissions 2008 Edition). This monitor has a manufacturing carbon footprint of approximately 30 kg.

Note: The manufacturing and operating carbon footprints are calculated by a unique algorithm developed exclusively by NEC for its monitors.

Troubleshooting

No picture

- The signal cable should be completely connected to the display card/computer.
- The display card should be completely seated in its slot.
- Front Power Switch and computer power switch should be in the ON position.
- Check to make sure that a supported mode has been selected on the display card or system being used. (Please consult display card or system manual to change graphics mode.)
- Check the monitor and your display card with respect to compatibility and recommended settings.
- Check the signal cable connector for bent or pushed-in pins.
- If the front LED is dark blue, check the status of the IPM mode (see page 12).

Power Button does not respond

- Unplug the power cord of the monitor from the AC outlet to turn off and reset the monitor.

Image Persistence

- Please be aware that LCD Technology may experience a phenomenon known as Image Persistence. Image Persistence occurs when a residual or “ghost” image of a previous image remains visible on the screen. Unlike CRT monitors, LCD monitors’ image persistence is not permanent, but constant images being displayed for a long period of time should be avoided. To alleviate image persistence, turn off the monitor for as long as the previous image was displayed. For example, if an image was on the monitor for one hour and a residual image remains, the monitor should be turned off for one hour to erase the image.

NOTE: As with all personal display devices, NEC DISPLAY SOLUTIONS recommends displaying moving images and using a moving screen saver at regular intervals whenever the screen is idle or turning off the monitor when not in use.

Message “OUT OF RANGE” is displayed (screen is either blank or shows rough images only)

- Image is displayed only roughly (pixels are missing) and OSD warning “OUT OF RANGE” is displayed: Either signal clock or resolution is too high. Choose one of the supported modes.
- OSD warning “OUT OF RANGE” is displayed on a blank screen: Signal frequency is out of range. Choose one of the supported modes.

Image is unstable, unfocused or swimming is apparent

- Signal cable should be completely attached to the computer.
- Use the OSD Image Adjust controls to focus and adjust display by increasing or decreasing the fine total. When the display mode is changed, the OSD Image Adjust settings may need to be re-adjusted.
- Check the monitor and your display card with respect to compatibility and recommended signal timings.
- If your text is garbled, change the video mode to non-interlace and use 60Hz refresh rate.

LED on monitor is not lit (no blue or amber colour can be seen)

- Power Switch should be in the ON position and power cord should be connected.

Picture is not as bright

- Make sure ECO MODE is turned off.
- If the brightness fluctuates make sure AUTO BRIGHTNESS is turned off.

Display image is not sized properly

- Use the OSD Image Adjust controls to increase or decrease the H. SIZE.
- Check to make sure that a supported mode has been selected on the display card or system being used. (Please consult display card or system manual to change graphics mode.)

No Video

- Make certain the computer is not in a power-saving mode (touch the keyboard or mouse).
- Some video cards do not output video signal when monitor is turned OFF/ON or disconnect/connect from the AC power cord under low resolution with DisplayPort.

No Sound

- Make sure the speaker cable is proper connected.
- Check to see if mute is activated.
- Check the volume in the OSD menu.

Brightness difference during multiple monitor usage

- Change Auto Brightness to OFF and adjust brightness.

NOTE: When Auto Brightness is set to ON, the monitor automatically adjusts brightness to the environment. When condition is difference, monitor brightness will be difference.

Using the Auto Brightness function

The brightness of the LCD screen can be set to increase or decrease depending on the amount of ambient light within the room. If the room is bright, the monitor becomes correspondingly bright. If the room is dim, then the monitor will dim accordingly. The purpose of this function is to make the viewing experience more comfortable to the eye in a variety of lighting conditions.

The Auto Brightness function is set to 1 by default.

SETUP

Use the following procedure to select the Brightness Range that the monitor will use when the Auto Brightness function is activated.

1. Set the BRIGHT level. This is the brightness level that the monitor will go up to when the ambient light level is highest. Make sure the room is at its brightest when setting this level.

Select "1" or "3" in the AUTO BRIGHTNESS menu (Figure 1). Then use the front buttons to move the cursor up to the BRIGHTNESS setting. Choose the desired brightness level (Figure 2).



Figure 1



Figure 2

2. Set the DARK level. This is the level of brightness that the monitor will go down to when the ambient light level is low. Make sure the room is at its darkest when setting this level.

Then use the front buttons to move the cursor up to the BRIGHTNESS setting. Choose the desired brightness level (Figure 3).

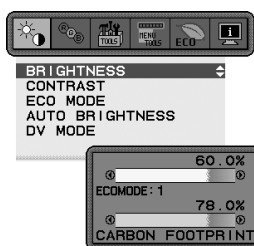


Figure 3

When the "Auto Brightness" function is enabled the Brightness level of the screen changes automatically according to the lighting conditions of the room (Figure 4).

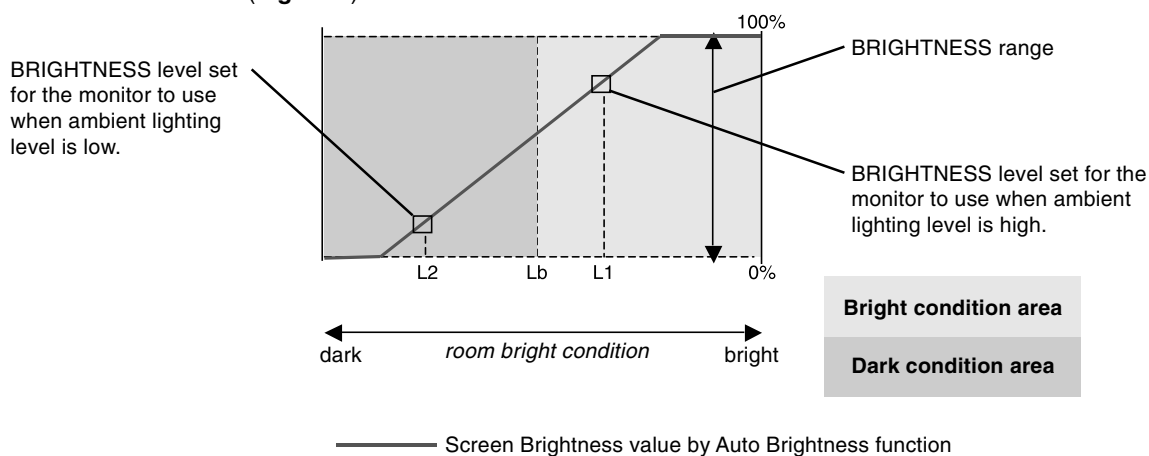


Figure 4

Lb: Border between bright and dim lighting conditions; set at factory
 L1: BRIGHTNESS level set for the monitor to use when ambient lighting level is high ($L1 > Lb$)
 L2: BRIGHTNESS level set for the monitor to use when ambient lighting level is low ($L2 < Lb$)

L1 and L2 are the brightness levels set by you to compensate for changes in ambient lighting.

Congratulations!

This display is designed for both you and the planet!



The display you have just purchased carries the TCO Certified label. This ensures that your display is designed, manufactured and tested according to some of the strictest quality and environmental requirements in the world. This makes for a high performance product, designed with the user in focus that also minimizes the impact on the climate and our natural environment.

TCO Certified is a third party verified program, where every product model is tested by an accredited impartial test laboratory. TCO Certified represents one of the toughest certifications for displays worldwide.

Some of the Usability features of the TCO Certified for displays:

- Good visual ergonomics and image quality is tested to ensure top performance and reduce sight and strain problems. Important parameters are luminance, contrast, resolution, black level, gamma curve, color and luminance uniformity, color rendition and image stability.
- Product have been tested according to rigorous safety standards at an impartial laboratory.
- Electric and magnetic fields emissions as low as normal household background levels.
- Low acoustic noise emissions.

Some of the Environmental features of the TCO Certified for displays:

- The brand owner demonstrates corporate social responsibility and has a certified environmental management system (EMAS or ISO 14001).
- Very low energy consumption both in on- and standby mode minimize climate impact.
- Restrictions on chlorinated and brominated flame retardants, plasticizers, plastics and heavy metals such as cadmium, mercury and lead (RoHS compliance).
- Both product and product packaging is prepared for recycling.
- The brand owner offers take-back options.

The requirements can be downloaded from our web site. The requirements included in this label have been developed by TCO Development in co-operation with scientists, experts, users as well as manufacturers all over the world. Since the end of the 1980s TCO has been involved in influencing the development of IT equipment in a more user-friendly direction. Our labeling system started with displays in 1992 and is now requested by users and IT-manufacturers all over the world. About 50% of all displays worldwide are TCO certified.

For more information, please visit
www.tcodevelopment.com



Technology for you and the planet

Manufacturer's Recycling and Energy Information

NEC DISPLAY SOLUTIONS is strongly committed to environmental protection and sees recycling as one of the company's top priorities in trying to minimize the burden placed on the environment. We are engaged in developing environmentally-friendly products, and always strive to help define and comply with the latest independent standards from agencies such as ISO (International Organisation for Standardization) and TCO (Swedish Trades Union).

Disposing of your old NEC product

The aim of recycling is to gain an environmental benefit by means of re-use, upgrading, reconditioning or reclamation of material. Dedicated recycling sites ensure that environmentally harmful components are properly handled and securely disposed. To ensure the best recycling of our products, **NEC DISPLAY SOLUTIONS offers a variety of recycling procedures** and gives advice on how to handle the product in an environmentally sensitive way, once it has reached the end of its life.

All required information concerning the disposal of the product and country-specific information on recycling facilities can be found on our following websites:

<http://www.nec-display-solutions.com/greencompany/> (in Europe),

<http://www.nec-display.com> (in Japan) or

<http://www.necdisplay.com> (in USA).

Energy Saving

This monitor features an advanced energy saving capability. When a VESA Display Power Management Signalling (DPMS) Standard signal is sent to the monitor, the Energy Saving mode is activated. The monitor enters a single Energy Saving mode.

Mode	Power consumption	LED colour
Maximum Operation	32 W	Blue
Normal Operation	23 W Default setting, Audio sleeping	Blue
Energy Saving Mode	0.42 W	Amber
Off Mode	0.35 W	Unlit

WEEE Mark (European Directive 2002/96/EC)



Within the European Union

EU-wide legislation, as implemented in each Member State, requires that waste electrical and electronic products carrying the mark (left) must be disposed of separately from normal household waste. This includes monitors and electrical accessories, such as signal cables or power cords. When you need to dispose of your NEC display products, please follow the guidance of your local authority, or ask the shop where you purchased the product, or if applicable, follow any agreements made between yourself and NEC.

The mark on electrical and electronic products only applies to the current European Union Member States.

Outside the European Union

If you wish to dispose of used electrical and electronic products outside the European Union, please contact your local authority so as to comply with the correct disposal method.