

# Technical Compliance Statement

## FCC and ISED Test Report

For the following information

Ref. File No.: C1M2105040

Product : LCD Monitor  
Model Number : (1)Sharp PN-HS431 (2)PN-HY431  
Brand Name : SHARP  
Applicant : Top Victory Electronics (Taiwan) Co., Ltd.  
Rules and Standards : Title 47 FCC CFR, Part 15, Subpart B, Class A  
ICES-003 Issue 6, Class A  
ANSI C63.4-2014

We hereby certify that the above product has been tested by us and complied with the FCC and ISED official limits. The product might be marketed in US in accordance with the standard 47 CFR FCC Part 2 and Part 15 Subpart B class A equipment regulations under FCC Rules. The test was performed according to the procedures mentioned in ANSI C63.4-2014.  
The test data and results are issued on the test report no. **EM-F210377**.

Signature



Alex Deng/Deputy Manager

Date: 2021. 06. 02

Test Laboratory:

AUDIX Technology Corporation, EMC Department

NVLAP Lab. Code: 200077-0

FCC OET Designation: TW1004 & TW1090

Web Site: [www.audixtech.com](http://www.audixtech.com)

The statement is based on a single evaluation of one sample of the above-mentioned products. It does not imply an assessment of the whole production and does not permit the use of the test lab logo.

## TEST REPORT

LCD Monitor

Model Number: (1)Sharp PN-HS431 (2)PN-HY431

Brand: SHARP

**Applicant for:**

Top Victory Electronics (Taiwan) Co., Ltd.  
10F, No. 230, Liancheng Road, Zhonghe Dist.,  
New Taipei City 23553, Taiwan R. O. C.

**Prepared by:**

Audix Technology Corporation, EMC Department  
No. 491, Zhongfu Rd., Linkou Dist.,  
New Taipei City 244, Taiwan



File No. : C1M2105040  
Report No. : EM-F210377  
Date of Report : 2021. 06. 02

The test report is based on a single evaluation of one sample of the above-mentioned products. It does not imply an assessment of the whole production and does not permit the use of the test lab logo. The report must not be used by the client to claim product certification, approval, or endorsement by NVLAP, NIST, or any agency of the U.S. Government.

## Test Report

Applicant : Top Victory Electronics (Taiwan) Co., Ltd.  
EUT Description  
(1) Product : LCD Monitor  
(2) Model : (1)Sharp PN-HS431 (2)PN-HY431  
(3) Brand : SHARP  
(4) Power Rating : AC 100-240V, 50/60Hz

### Rules of Compliance and Applicable Standards:

Title 47 FCC CFR, Part 15, Subpart B, Class A  
ICES-003 Issue 6, Class A  
ANSI C63.4-2014

The device described above was tested by Audix Technology Corporation to determine the maximum emission levels emanating from the device. All of the tests were requested by the applicant and the results there of based upon the information that the applicant provided to us. We, Audix Technology Corporation assumes full responsibility for the accuracy and completeness of these measurements. This report is made under FCC Part 2.938 and ICES-003 chapter 7, and shows that the EUT is technically compliance with the class A limit for both FCC rule and ICES standard described as above.

No modifications were required during testing to bring this product into compliance.

This report applies to above tested sample only and shall not be reproduced in part without written approval of Audix Technology Corporation.

Date of Report: 2021. 06. 02

Reviewed by:

Albee Lee

(Albee Lee/Administrator)

Approved by:

Alex Deng

(Alex Deng/Deputy Manager)

Name of the Representative of the Responsible Party:

Signature:

\_\_\_\_\_

## Table of Content

<b>1. Revision of Test Report</b> .....	<b>4</b>
<b>2. Summary of Test Result</b> .....	<b>5</b>
2.1. Test Result.....	5
2.2. Description of Test Firm.....	6
<b>3. General Information</b> .....	<b>7</b>
3.1. Description of Application.....	7
3.2. Description of the EUT.....	8
3.3. Highest Frequency within EUT.....	9
3.4. List of Key Components of EUT.....	9
3.5. Determination of Worse Case Operating Modes.....	10
3.6. Final Test Configuration.....	10
<b>4. Measurement Arrangement</b> .....	<b>11</b>
4.1. Equipment and cables arrangement.....	11
4.2. Method of Exercising EUT.....	12
4.3. List of Supported Units under Test.....	13
4.4. List of Used Cables under Test.....	13
<b>5. Measurement of Conducted Emissions</b> .....	<b>14</b>
5.1. List of Test Instruments.....	14
5.2. Test Setup.....	14
5.3. Power-line Conducted Emission Limits.....	15
5.4. Measurement Procedure.....	15
5.5. Measurement Result.....	16
<b>6. Measurement of Radiated Emissions</b> .....	<b>18</b>
6.1. List of Test Instruments.....	18
6.2. Test Setup.....	19
6.3. Radiation Emission Limits.....	20
6.4. Measurement Procedure.....	21
6.5. Measurement Result.....	22
<b>7. Measurement Uncertainty List</b> .....	<b>28</b>
<b>8. Photographs</b> .....	<b>31</b>
8.1. Powerline Conducted Emission Measurement.....	31
8.2. Radiated Emissions Measurement.....	32

## 1. Revision of Test Report

Issued Date	Revision Summary	Report Number
2021. 06. 02	Original Report.	EM-F210377

## 2. Summary of Test Result

### 2.1. Test Result

Test Item	Referred Rules/Standard	Limit	Result
Power-line conducted emission	Title 47 FCCCFR Part 15 Subpart B and ICES-003 Issue 6	Class A	<b>Pass</b>
			Margin 19.84dB at 3.381MHz
Radiated emission (30 – 1000MHz)	Title 47 FCCCFR Part 15 Subpart B and ICES-003 Issue 6	Class A	<b>Pass</b>
			Margin 6.36dB at 46.2368MHz (Vertical, 1.0m/295°)
Radiated emission (Above 1GHz)	Title 47 FCCCFR Part 15 Subpart B and ICES-003 Issue 6	Class A	<b>Pass</b>
			Margin 19.37dB at 25680.170MHz
<p>Note :</p> <ol style="list-style-type: none"> <li>1. The uncertainties value is not used in determining the result.</li> <li>2. N/A is an abbreviation for Not Applicable</li> <li>3. Special measures: None</li> <li>4. Decision and justification not to measure: None</li> <li>5. The FCC Part 15 Subpart B emission measurement results are deemed satisfactory evidence of compliance with ICES-003 regulations.</li> </ol>			

## 2.2. Description of Test Firm

Name of Test Firm	Audix Technology Corporation / EMC Department No. 491, Zhongfu Rd., Linkou Dist., New Taipei City 244, Taiwan Tel: +886-2-26092133 Fax: +886-2-26099303 Website : www.audixtech.com Contact e-mail: <a href="mailto:attemc_report@audixtech.com">attemc_report@audixtech.com</a>
Accreditations	The laboratory is accredited by following organizations under ISO/IEC 17025:2017  (1) NVLAP(USA) NVLAP Lab Code 200077-0  (2) TAF(Taiwan) No. 1724
Test Facilities	FCC OET Designation Number under APEC MRA by BSMI is : TW1004 & TW1090  (1) No. 5 Shielding Room (2) No. 6 Open Area Test Site (3) No. 1 10m Semi Anechoic Chamber

### 3. General Information

#### 3.1. Description of Application

Applicant	Top Victory Electronics (Taiwan) Co., Ltd. 10F, No. 230, Liancheng Road, Zhonghe Dist., New Taipei City 23553, Taiwan R. O. C
Product	LCD Monitor
Brand	SHARP
Model	(1)Sharp PN-HS431 (2)PN-HY431  The differences between above models is in brightness. Sharp PN-HS431: 700nits ; PN-HY431: 500nits



### 3.2. Description of the EUT

Test Model	Sharp PN-HS431
Serial Number	N/A
Power Rating	AC 100-240V, 50/60Hz
Firmware Version	N/A
Sample Status	Trial sample
Date of Receipt	2021. 05. 04
Date of Test	2021. 05. 13 ~ 18
I/O Ports List	<p><b>Bottom View</b></p> <ul style="list-style-type: none"> <li>• One AC IN</li> <li>• Two HDMI Input Ports</li> <li>• One LAN Port</li> <li>• One Audio Port</li> <li>• One RS-232 Input Port</li> </ul> <p><b>Side View</b></p> <ul style="list-style-type: none"> <li>• One Audio (L/R) set Port</li> <li>• One USB Port</li> <li>• One Earphone Port</li> <li>• One D-Sub Input Port</li> <li>• One HDMI Input Port</li> </ul>
Accessories	<ul style="list-style-type: none"> <li>• Base</li> <li>• Remote Control</li> <li>• AC Power Cord (3C)</li> </ul>

### 3.3. Highest Frequency within EUT

The highest frequency operating in EUT is over 108MHz. The highest measured frequency is performed according to the requirement of FCC Part 15.33.

### 3.4. List of Key Components of EUT

Item	Supplier/Brand	Model	Specification
LCD Panel #1			Max. Resolution: 4096*2160/60Hz 700nits
LCD Panel #2			500nits
Base #1	SHARP	PN-ZS601	--
Base #2	SHARP	XS-3247	--
Base #3	SHARP	CMP-45SC	--
Remote Control	SHARP	--	--

### 3.5. Determination of Worse Case Operating Modes

According to the specification, the EUT was estimated to determine the highest emissions by following configurations:

Test Item	Test Voltage	Power Cord	Input Port	Base	Test Panel	Panel Angle	Resolution/Frequency
Power-line conducted emission & Radiated emission	AC 230V, 50Hz	3m	HDMI 1	#1	#1	0°	"H Pattern", 4096*2160/60Hz
			HDMI 2				"H Pattern", 4096*2160/60Hz
			HDMI 3				"H Pattern", 4096*2160/60Hz
			D-Sub				"H Pattern", 1920*1080/60Hz
			HDMI 1				"H Pattern", 1920*1080/60Hz
							"H Pattern", 1280*1024/75Hz
							"H Pattern", 640*480/60Hz
			90°			"H Pattern", 2160*4096/60Hz	
		1.8m	0°			LAN	Linking to Public Internet
						USB	Playing and sending the image
	HDMI 1			"H Pattern", 4096*2160/60Hz			
	3m	0°	HDMI 1	#2	#1	"H Pattern", 4096*2160/60Hz	
	3m	0°	HDMI 1	#3	#1	"H Pattern", 4096*2160/60Hz	
	3m	0°	HDMI 1	#1	#2	"H Pattern", 4096*2160/60Hz	
AC 120V, 60Hz	3m	HDMI 1	#1	#1	0°	"H Pattern", 4096*2160/60Hz	

### 3.6. Final Test Configuration

The worst showed as following configuration was recorded in this report.

Test Item	Test Voltage	Power Cord	Input Port	Base	Test Panel	Panel Angle	Resolution/Frequency
Power-line conducted emission	AC 120V, 60Hz	3m	HDMI 1	#1	#1	0°	"H Pattern", 4096*2160/60Hz
Radiated emission	AC 120V, 60Hz	3m	HDMI 1	#1	#1	0°	"H Pattern", 4096*2160/60Hz

## 4. Measurement Arrangement

### 4.1. Equipment and cables arrangement

- Connection Diagram of EUT and Peripheral Devices

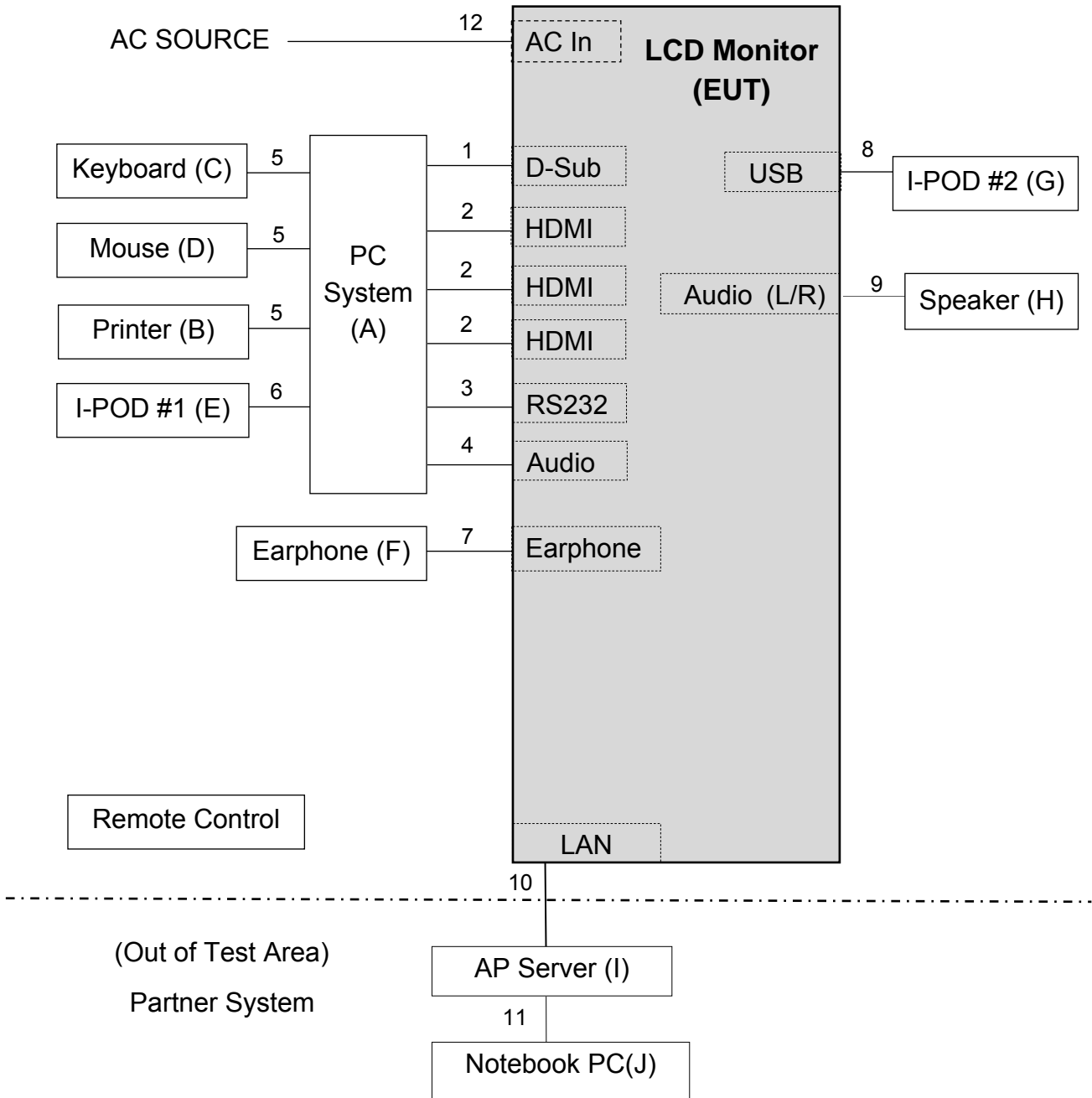

## 4.2. Method of Exercising EUT

The methods for exercising the EUT during the measurement specified in ANSI C63.4-2014 clause 11.2, 11.3 and figure 16 were used.

Operating System	Windows 10 of PC system
Test Program	“IBM Test” , “Mediaplayer”
Video Signal (Display Image)	scrolling H Pattern
Audio Signal	Play 1kHz Audio Signal
USB Signal	Read/Write operation to I-POD.
Wired Network	Transmitting 10/100Base-T ethernet traffic
Wireless LAN	Linking to Public Internet via AP Server
Other	Other peripheral devices were driven and operated in turn

### 4.3. List of Supported Units under Test

Item	Product	Brand	Model No.	Serial No.	Approval
A	PC System	LENOVO	S08F00	PC1ABA9Z	By DoC
B	Printer	SAMSUNG	ML-1630	4561B1CP600023X	FCC ID: A3LML1630
C	Keyboard	LENOVO	KU-1619	8SSD50L79990AVL C9A400VN	By DoC
D	Mouse	LENOVO	MODWUOA	4471161	By DoC
E	I-POD Player #1	APPLE	A1204	4H722THMVTE	By DoC
F	Earphone	LGITON	FS-99	N/A	N/A
G	I-POD Player #2	APPLE	A1204	4H722TJRVTE	By DoC
H	Speaker	Edifier	S330D	N/A	N/A
Partner System					
I	AP Server	D-Link	Di-624	F34U177001195	FCC ID: KA2DI624D2
J	Notebook PC	HP	TPN-Q110	5CD2104T9D	FCC ID: PD92230BNH

### 4.4. List of Used Cables under Test

Item	Type	Qty.	Length (m)	Shielding (Yes/No)	Cores (Qty.)	Remark
1	D-Sub Cable	1	1.8	Y	0	Provided by LAB
2	HDMI Cable	3	1.8	Y	0	Provided by LAB
3	RS232 Cable	1	1.5	N	0	Provided by LAB
4	Audio Cable	1	1.8	N	0	Provided by LAB
5	USB Cable	3	1.8	Y	0	Provided by LAB
6	USB Cable	1	1.0	Y	0	Provided by LAB
7	Earphone Cable	1	2.0	N	0	Provided by LAB
8	USB Cable	1	1.0	Y	0	Provided by LAB
9	Audio Cable	1	1.5	N	0	Provided by LAB
10	LAN Cable	1	10.0	N	0	Provided by LAB
11	LAN Cable	1	3.0	N	0	Provided by LAB
12	AC Power Cord (3C)	1	3.0	N	0	Accessory of EUT
		1	1.8	N	0	Accessory of EUT
13	AC Power Cord	3	1.8	N	0	Provided by LAB for above supported units

## 5. Measurement of Conducted Emissions

### 5.1. List of Test Instruments

Item	Equipment	Manufacture	Model No.	Serial No.	Cal. Date	Cal. Interval
1	Test Receiver	R&S	ESCS30	100265	2020. 06. 17	1 Year
2	A.M.N.	R&S	ENV4200	100003	2020. 09. 16	1 Year
3	L.I.S.N.	Kyoritsu	KNW-407	8-1539-2	2020. 12. 16	1 Year
4	Pulse Limiter	R&S	ESH3-Z2	100355	2021. 01. 04	1 Year
5	Digital Thermo-Hygro Meter	WISEWIND	5330	No.5 S/R	2021. 04. 15	1 Year
6	Signal Cable	MIYAZAKI	5D2W	CE-04	2021. 01. 29	1 Year
7	Test Software	Audix	e3	V6.120703a	N.C.R.	N.C.R.

### 5.2. Test Setup

The EUT and test equipment were configured in accordance with the requirement of ANSI C63.4-2014 clause 5.2.

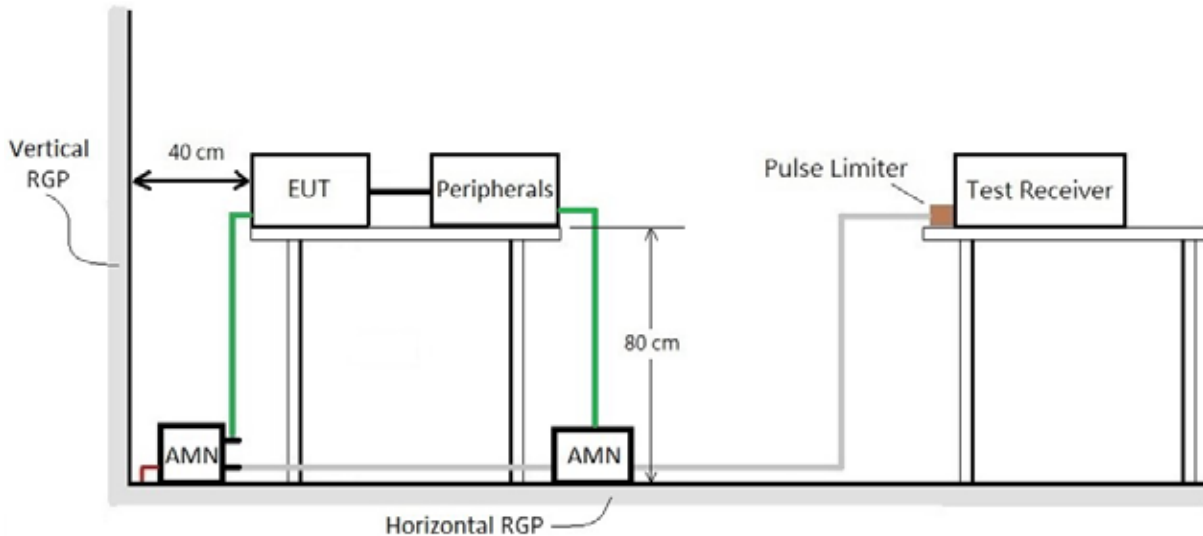

### 5.3. Power-line Conducted Emission Limits

- For FCC §15.107 and ICES-003 §6.1

Frequency Range (MHz)	Class A Limits		Class B Limits	
	Quasi Peak dB(μV)	Average dB(μV)	Quasi Peak dB(μV)	Average dB(μV)
0.15 – 0.50	79	66	66 – 56*	56 – 46*
0.50 – 5.0	73	60	56	46
5.0 – 30			60	50

Note: \* Decreases with the logarithm of the frequency.

### 5.4. Measurement Procedure

The power-line conducted emission measurement was performed in accordance with the procedure of ANSI C63.4-2014 clause 7.3.

- Setup the EUT and associated equipment described as section 4.1, and they were located 40cm from the vertical conducting plane.
- Connect the EUT power cord to the main A.M.N and associated equipment to the second A.M.N. All ports of the A.M.N not connecting to the measuring equipment was terminated into 50 ohm resistive load.
- Setup the resolution bandwidth of the test receiver at 9kHz (while testing within 0.15 to 30MHz).
- Operate the EUT system as described in section 4.2.
- Both sides of A.C. line were checked for maximum conducted interference. In order to find the maximum emission, all of the interconnecting cables were manipulated.
- For the exploratory measurement, determine the highest emission amplitude relative to the limit on each of the EUT power cord with the peak detector by each of the EUT operation over the specified frequency range and record it.
- For final measurement, select the EUT operation mode that produced the highest amplitude in the exploratory measurement to determine the highest emissions with each specified detector and record it. All of the current-carrying conductors of each of the EUT power cords, except the ground conductor, must be measured over the specified frequency range.
- The measurement result was calculated by following formula:  

$$\text{Emission Level (dB}\mu\text{V)} = \text{Reading (Receiver) (dB}\mu\text{V)} + \text{Factor (A.M.N) (dB)} + \text{Cable Loss (dB)} + \text{Pulse Limiter (dB)}$$
- If the average limit is met when using a Quasi-Peak detector receiver, the EUT is deemed to meet both limits and measurement with the average detector is unnecessary.







## 6. Measurement of Radiated Emissions

### 6.1. List of Test Instruments

- For measurement of 30 to 1000MHz frequency range

Item	Equipment	Manufacture	Model No.	Serial No.	Cal. Date	Cal. Interval
1	Spectrum Analyzer	Agilent	N9010A-503	MY51120074	2020. 10. 19	1 Year
2	Test Receiver	R&S	ESCS30	100338	2020. 06. 10	1 Year
3	Amplifier	HP	8447D	2727A05737	2021. 01. 04	1 Year
4	Bilog Antenna	Schaffner	CBL6112B	2818	2021. 01. 15	1 Year
5	Signal Cable	HUBER+SUHNER	RG217U	RE-07	2020. 05. 28	1 Year
6	Test Software	Audix	e3	V5.04507	N.C.R.	N.C.R.
7	Digital Thermo-Hygro Meter	iMax	HTC-1	No.6 O/S	2021. 04. 15	1 Year

- For measurement of above 1GHz frequency range

Item	Type	Manufacture	Model No.	Serial No.	Cal. Date	Cal. Interval
1	Spectrum Analyzer (1~18G)	Keysight	N9010B-526	MY57410128	2021. 01. 07	1 Year
2	Spectrum Analyzer (18~40G)	Agilent	E4446A	US44300366	2020. 12. 02	1 Year
3	Microwave Preamplifier (1~18G)	Keysight	83017A	MY53270364	2020. 06. 02	1 Year
4	Microwave Preamplifier (18~40G)	Keysight	83051A	MY53010042	2020. 08. 05	1 Year
5	Double-Ridged Waveguide Horn (1~18G)	ETS-Lindgren	3117	00114403	2021. 04. 07	1 Year
6	Horn Antenna (18~40G)	COM-POWER	AH-840	101092	2021. 01. 05	1 Year
7	Signal Cable	HUBER+SUHNER	SUCOFLEX 104	RE-24	2021. 04. 21	1 Year
8	Coaxial Cable	HUBER+SUHNER	SUCOFLEX 102	RE-30	2020. 09. 19	1 Year
9	Digital Thermo-Hygro Meter	iMax	HTC-1	No.1 10m A/C	2021. 04. 15	1 Year
10	Test Software	Audix	e3	V6.120619c	N.C.R.	N.C.R.

## 6.2. Test Setup

The EUT and test equipment were configured in accordance with the requirement of ANSI C63.4-2014 clause 5.4. and 5.5.

- For frequency range 30 to 1000MHz (at Open Area Test Site)

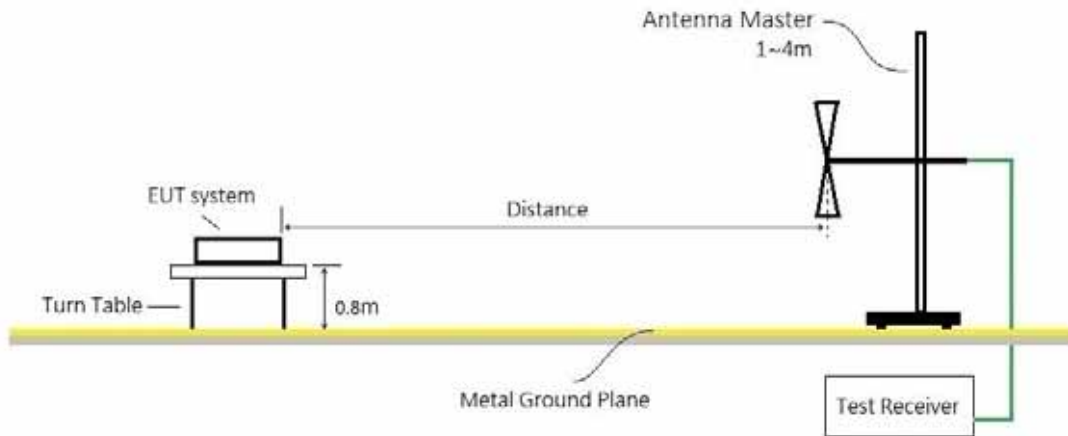

- For frequency range 30 to 1000MHz (at Semi Anechoic Chamber)

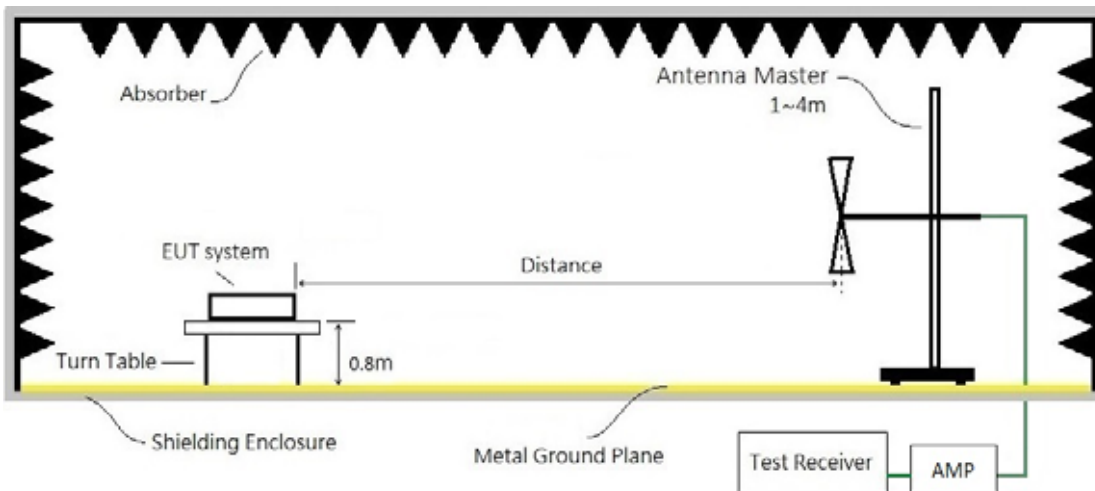

- For frequency range above 1GHz (at Semi Anechoic Chamber)

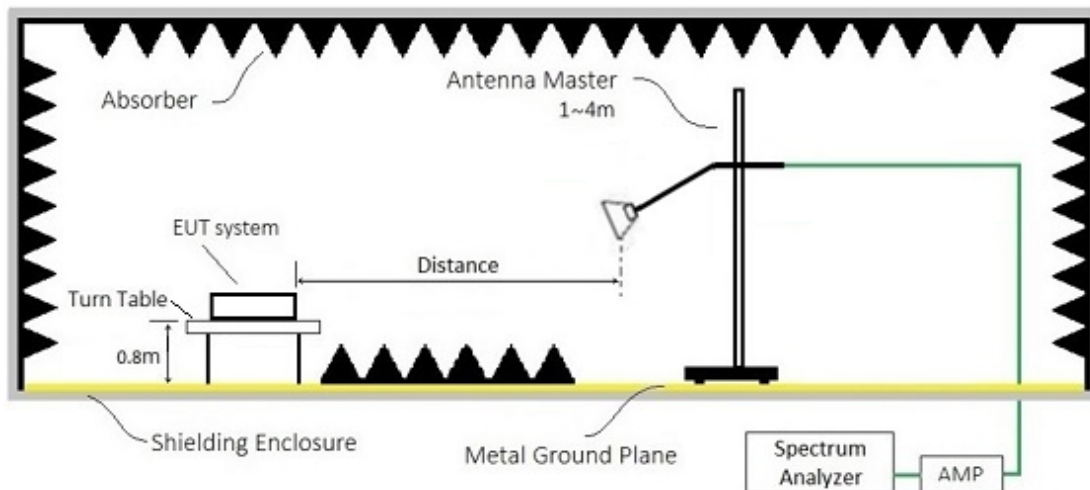

### 6.3. Radiation Emission Limits

- For Below 1GHz, FCC §15.109(a)(g)/CISPR 22 and ICES-003 §6.2

Frequency Range (MHz)	Distance (meter)	Class A Limits		Class B Limits	
		Quasi-Peak [dB(μV/m)]	Average [dB(μV/m)]	Quasi-Peak [dB(μV/m)]	Average [dB(μV/m)]
30 – 230	10	40	30	30	20
230 – 1000		47	37	37	27
30 – 230	3	50	40	40	30
230 – 1000		57	47	47	37

- For Above 1GHz, FCC §15.109(a)(g)/CISPR 22 and ICES-003 §6.2

Frequency Range (MHz)	Distance (meter)	Class A Limits		Class B Limits	
		Peak [dB(μV/m)]	Average [dB(μV/m)]	Peak [dB(μV/m)]	Average [dB(μV/m)]
Above 1000	3	79.54	59.54	73.98	53.98

- The tighter limit applies at the edge between two frequency bands.
- Distance refers to the distance in meters between the measuring instrument antenna and the closed point of any part of the E.U.T.
- The limits from 30 to 1000MHz are referred to CISPR 22 standard, which are in accordance with the requirement of FCC Part 15.38 (b)(3), Part 15.109 (a)(g) and ICES-003 section 5(a)(i).
- The limits above 1GHz are referred to FCC Part 15.109(a)

- Required highest frequency for radiated measurement

Highest frequency generated or used in the device or on which the device operates or tunes (MHz)	Upper frequency of measurement range (MHz)
Below 1.705	30
1.705 – 108	1000
108 – 500	2000
500 – 1000	5000
Above 1000	5th harmonic of the highest frequency or 40 GHz, whichever is lower.

## 6.4. Measurement Procedure

The radiated emission measurement was performed in accordance with the procedure of the ANSI C63.4-2014 clause 8.3.

- The EUT and peripherals were placed on the rotatable non-conduction table, which is 0.8meters above the ground reference plane at the semi-anechoic chamber or OATS as described in section 4.1 and 6.2.
- The measurement distance is set as specified in section 6.3. The specified distance is between the horizontal projection onto the ground plane of the closest periphery of the EUT and the projection onto the ground plane of the center of the axis of the elements of the receiving antenna.
- The resolution bandwidth of the test receiver was at 120kHz (testing from 30 to 1000MHz) or 1MHz (testing above 1000MHz).
- Operate the EUT system as described in section 4.2.
- For the exploratory measurement, determine the highest emission amplitude relative to the limit on each of antenna polarization with the peak detector by each of the EUT operations over the specified frequency range and record it.
- For final measurement, select the EUT operation mode that produced the highest amplitude in the exploratory measurement to determine the highest emissions with each specified detector and record it.
- In order to determine the maximum emission level, must rotate the table in 360 degree and move the receiving antenna between 1~4m height above the ground reference plane.
- In order to find the maximum emission, all of the interconnecting cables were manipulated, except for the bundled cable.
- Both polarizations of receiving antenna were determined.
- The measurement result was calculated by following formulas:

### **(30 – 1000MHz)**

$$\text{Emission Level (dB}\mu\text{V/m)} = \text{Reading (Receiver) (dB}\mu\text{V)} + \text{Antenna Factor (dB/m)} + \text{Cable Loss (dB)}$$

### **(Above 1GHz)**

$$\text{Emission Level (dB}\mu\text{V/m)} = \text{Reading (Spectrum) (dB}\mu\text{V)} + \text{Antenna Factor (dB/m)} - \text{Preamp Gain (dB)} + \text{Cable Loss (dB)}$$

- The 3dB bandwidth of the horn antenna is minimum 52 degree (or  $w=2.93m$  at 3m distance) for 1~6 GHz.

### 6.5. Measurement Result

The following data are the worst emissions based on the prescan measurement result.

- For frequency range 30 – 1000MHz

Ant. Polarity	Horizontal	Test Result	Pass
Test Mode	“H Pattern”, 4096*2160/60Hz, HDMI 1	Test Model	Sharp PN-HS431

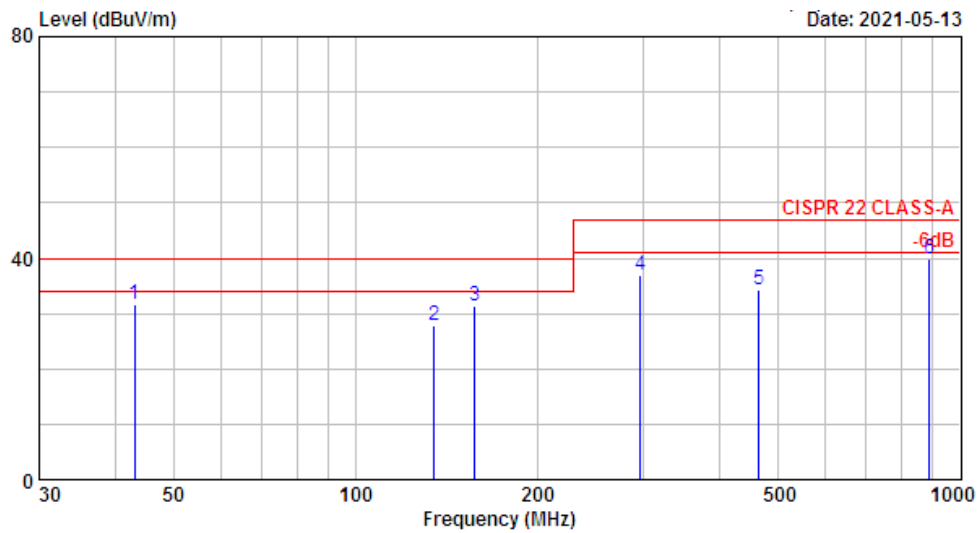

```

Site No.       : NO.6 Open Area Test Site   Data No.   : 42
Instrument 1   : Receiver ESCS(338)
Instrument 2   : CBL6112B (818) |RE-07
Distance / Limit : 10m / CISPR 22 CLASS-A   Ant. Pol.   : HORIZONTAL
Environment    : 29°C / 46%                 Engineer    : Eason Hsu
EUT Model     : Sharp PN-HS431              Test Rating : 120Vac / 60Hz
Test Mode     : 4096*2160/60Hz HDMI1
    
```

	Ant. Factor	Cable Loss	Reading	Emission Level	Limits	Margin	Remark
Freq. (MHz)	(dB/m)	(dB)	(dBμV)	(dBμV/m)	(dBμV/m)	(dB)	
1	43.125	18.30	0.88	12.57	31.76	40.00	8.24 QP
2	135.062	17.93	1.72	8.29	27.95	40.00	12.05 QP
3	157.628	16.71	1.95	12.58	31.24	40.00	8.76 QP
4	296.451	19.77	2.68	14.56	37.01	47.00	9.99 QP
5	465.258	23.56	3.45	7.17	34.18	47.00	12.82 QP
6	890.478	27.19	5.08	7.53	39.80	47.00	7.20 QP

Remarks: 1. Emission Level= Antenna Factor + Cable Loss + Reading.  
 2. The emissions not reported are 20 dB lower than the specified limit.

Ant. Polarity	Vertical	Test Result	Pass
Test Mode	"H Pattern", 4096*2160/60Hz, HDMI 1	Test Model	Sharp PN-HS431

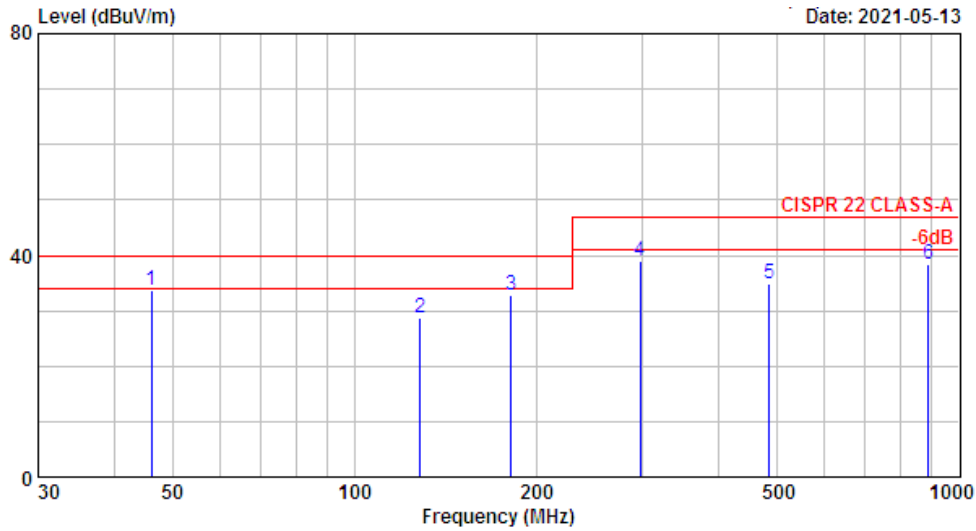

Site No. : NO.6 Open Area Test Site      Data No. : 41  
 Instrument 1 : Receiver ESCS(338)  
 Instrument 2 : CBL6112B (818)|RE-07  
 Distance / Limit : 10m / CISPR 22 CLASS-A      Ant. Pol. : VERTICAL  
 Environment : 29°C / 46%      Engineer : Eason Hsu  
 EUT Model : Sharp PN-HS431      Test Rating : 120Vac / 60Hz  
 Test Mode : 4096\*2160/60Hz HDMI1

	Freq. (MHz)	Ant. Factor (dB/m)	Cable Loss (dB)	Reading (dBuV)	Emission Level (dBuV/m)	Limits (dBuV/m)	Margin (dB)	Remark
1	46.236	16.55	0.92	16.17	33.64	40.00	6.36	QP
2	128.659	18.30	1.67	8.66	28.63	40.00	11.37	QP
3	181.759	15.63	2.23	14.83	32.70	40.00	7.30	QP
4	296.854	19.77	2.68	16.40	38.85	47.00	8.15	QP
5	485.751	23.90	3.52	7.34	34.76	47.00	12.24	QP
6	891.260	27.19	5.08	6.06	38.32	47.00	8.68	QP

Remarks: 1. Emission Level= Antenna Factor + Cable Loss + Reading.  
 2. The emissions not reported are 20 dB lower than the specified limit.



- For frequency range above 1 GHz

Ant. Polarity	Horizontal	Test Result	Pass
Test Mode	"H Pattern", 4096*2160/60Hz, HDMI 1	Test Model	Sharp PN-HS431

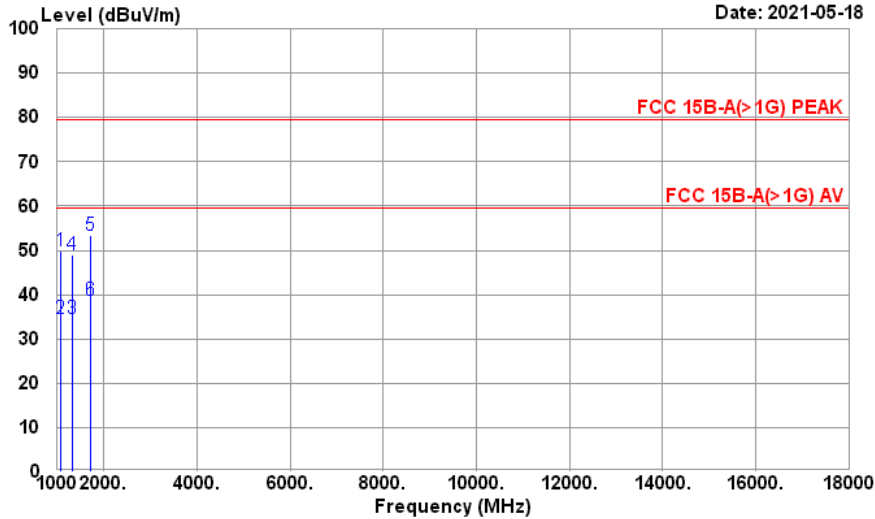

Site No. : No.1 10m Semi Anechoic Chamber      Data No. : 34  
 Instrument 1 : Spectrum N9010B(128)  
 Instrument 2 : 3117 (403)|RE-24|83017A (364)  
 Distance/Limit : 3m / FCC 15B-A(>1G) PEAK      Ant. Pol. : HORIZONTAL  
 Environment : 25°C / 50%      Engineer : Xar Zhuo  
 EUT Model : Sharp PN-HS431      Test Rating : 120Vac/60Hz  
 Test Mode : 4096\*2160/60Hz HDMI 1

	Freq. (MHz)	Ant. Factor (dB/m)	Cable Loss (dB)	Preamp Gain (dB)	Reading (dBμV)	Emission Level (dBμV/m)	Limits (dBμV/m)	Margin (dB)	Remark
1	1070.000	28.42	1.95	37.20	56.73	49.90	79.54	29.64	Peak
2	1072.456	28.36	1.95	37.20	41.43	34.54	59.54	25.00	Average
3	1322.345	27.95	2.15	36.12	40.64	34.62	59.54	24.92	Average
4	1325.000	27.95	2.15	36.12	54.94	48.92	79.54	30.62	Peak
5	1720.000	29.36	2.70	35.02	56.42	53.46	79.54	26.08	Peak
6	1721.345	29.36	2.70	35.02	41.64	38.68	59.54	20.86	Average

Remarks: 1. Emission Level= Antenna Factor + Cable Loss - Preamp Gain + Reading.  
 2. The emissions not reported are 20 dB lower than the specified limit.

Ant. Polarity	Vertical	Test Result	Pass
Test Mode	"H Pattern", 4096*2160/60Hz, HDMI 1	Test Model	Sharp PN-HS431

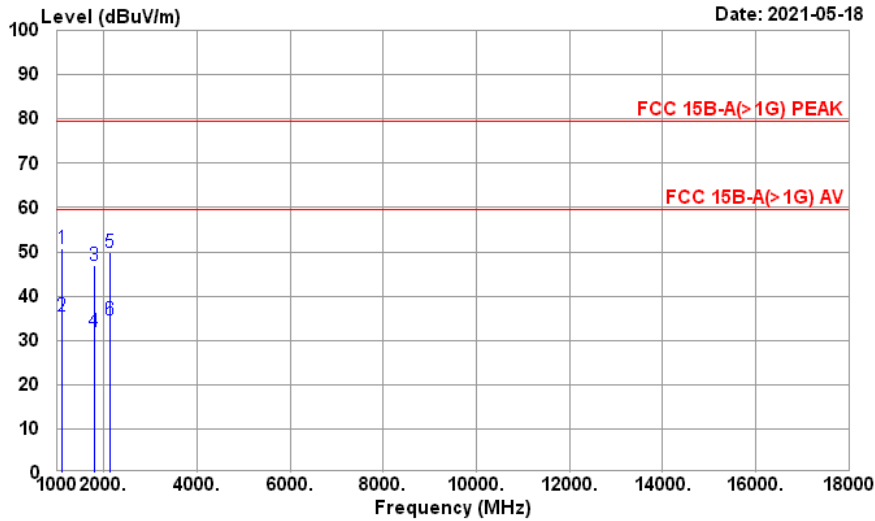

Site No. : No.1 10m Semi Anechoic Chamber Data No. : 33  
 Instrument 1 : Spectrum N9010B(128)  
 Instrument 2 : 3117 (403)|RE-24|83017A (364)  
 Distance/Limit : 3m / FCC 15B-A(>1G) PEAK Ant. Pol. : VERTICAL  
 Environment : 25°C / 50% Engineer : Xar Zhuo  
 EUT Model : Sharp PN-HS431 Test Rating : 120Vac/60Hz  
 Test Mode : 4096\*2160/60Hz HDMI 1

	Freq. (MHz)	Ant. Factor (dB/m)	Cable Loss (dB)	Preamp Gain (dB)	Reading (dBμV)	Emission Level (dBμV/m)	Limits (dBμV/m)	Margin (dB)	Remark
1	1105.000	27.88	1.97	37.09	57.84	50.60	79.54	28.94	Peak
2	1106.641	27.88	1.97	37.09	42.66	35.42	59.54	24.12	Average
3	1810.000	30.44	2.77	34.85	48.50	46.86	79.54	32.68	Peak
4	1811.654	30.56	2.77	34.85	33.64	32.12	59.54	27.42	Average
5	2125.000	31.65	3.17	34.45	49.37	49.74	79.54	29.80	Peak
6	2125.645	31.65	3.17	34.45	34.34	34.71	59.54	24.83	Average

Remarks: 1. Emission Level= Antenna Factor + Cable Loss - Preamp Gain + Reading.  
 2. The emissions not reported are 20 dB lower than the specified limit.

Ant. Polarity	Horizontal	Test Result	Pass
Test Mode	"H Pattern", 4096*2160/60Hz, HDMI 1	Test Model	Sharp PN-HS431

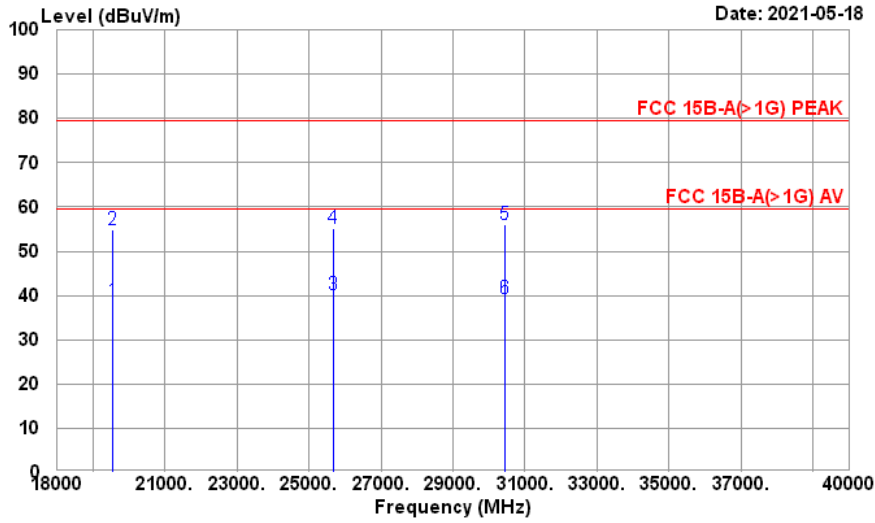

Site No. : No.1 10m Semi Anechoic Chamber      Data No. : 42  
 Instrument 1 : Spectrum E4446A(366)  
 Instrument 2 : AH-840 (092)|RE-30|83051A (042)  
 Distance/Limit : 3m / FCC 15B-A(>1G) PEAK      Ant. Pol. : HORIZONTAL  
 Environment : 25°C / 50%      Engineer : Xar Zhuo  
 EUT Model : Sharp PN-HS431      Test Rating : 120Vac/60Hz  
 Test Mode : 4096\*2160/60Hz HDMI 1

	Freq. (MHz)	Ant. Factor (dB/m)	Cable Loss (dB)	Preamp Gain (dB)	Reading (dBμV)	Emission Level (dBμV/m)	Limits (dBμV/m)	Margin (dB)	Remark
1	19542.350	36.40	9.47	29.64	22.50	38.73	59.54	20.81	Average
2	19542.540	36.40	9.47	29.64	38.48	54.71	79.54	24.83	Peak
3	25680.170	36.38	11.14	30.82	23.47	40.17	59.54	19.37	Average
4	25680.450	36.38	11.14	30.82	38.53	55.23	79.54	24.31	Peak
5	30458.620	36.99	12.13	30.27	37.29	56.14	79.54	23.40	Peak
6	30458.790	36.99	12.13	30.27	20.41	39.26	59.54	20.28	Average

Remarks: 1. Emission Level= Antenna Factor + Cable Loss - Preamp Gain + Reading.  
 2. The emissions not reported are 20 dB lower than the specified limit.

Ant. Polarity	Vertical	Test Result	Pass
Test Mode	"H Pattern", 4096*2160/60Hz, HDMI 1	Test Model	Sharp PN-HS431

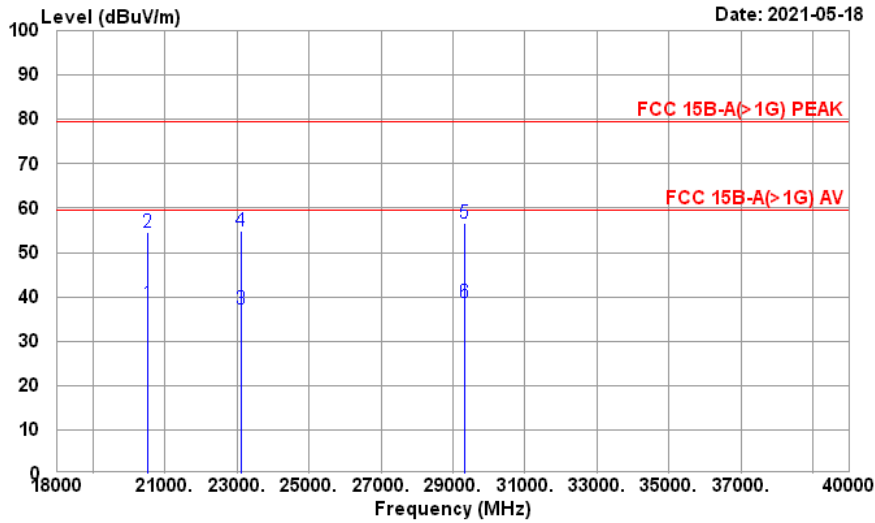

Site No. : No.1 10m Semi Anechoic Chamber      Data No. : 41  
 Instrument 1 : Spectrum E4446A(366)  
 Instrument 2 : AH-840 (092)|RE-30|83051A (042)  
 Distance/Limit : 3m / FCC 15B-A(>1G) PEAK      Ant. Pol. : VERTICAL  
 Environment : 25°C / 50%      Engineer : Xar Zhuo  
 EUT Model : Sharp PN-HS431      Test Rating : 120Vac/60Hz  
 Test Mode : 4096\*2160/60Hz HDMI 1

	Freq. (MHz)	Ant. Factor (dB/m)	Cable Loss (dB)	Preamp Gain (dB)	Reading (dBµV)	Emission Level (dBµV/m)	Limits (dBµV/m)	Margin (dB)	Remark
1	20527.460	36.99	9.74	29.28	20.97	38.42	59.54	21.12	Average
2	20527.980	36.99	9.74	29.28	37.17	54.62	79.54	24.92	Peak
3	23116.750	36.56	10.47	28.86	19.14	37.31	59.54	22.23	Average
4	23116.960	36.56	10.47	28.86	36.61	54.78	79.54	24.76	Peak
5	29336.540	36.80	11.80	30.62	38.56	56.54	79.54	23.00	Peak
6	29336.820	36.80	11.80	30.62	20.60	38.58	59.54	20.96	Average

Remarks: 1. Emission Level= Antenna Factor + Cable Loss - Preamp Gain + Reading.  
 2. The emissions not reported are 20 dB lower than the specified limit.

## 7. Measurement Uncertainty List

The measurement uncertainty was estimated for test on the EUT according to CISPR 16-4-2. This uncertainty represents an expanded uncertainty expressed at approximately the 95% confidence level using a coverage of K=2.

The uncertainties value is not used in determining the PASS/FAIL results.

Test Items/Facilities	Frequency/Equipment/Unit	Uncertainty
Conducted emissions at AC mains power port	9kHz-150kHz	±3.7dB
	150kHz-30MHz	±3.4dB
Conducted emissions at wired network port	150kHz-30MHz	±3.4dB
Conducted emissions at broadcast receiver tuner port	150kHz-30MHz	±3.4dB
Conducted emissions Power Clamp (No. 7 Shielded Room)	30MHz-300MHz	±4.4dB
Conducted emissions Power Clamp (No. 8 Shielded Room)	30MHz-300MHz	±4.4dB
Radiated, magnetic field (Triple-Loop Antenna)	9kHz-30MHz	±1.5dB
Radiated, magnetic field (Loop Antenna)	9kHz-150kHz	±3.1dB
	150kHz-30MHz	±3.0dB
Radiated emissions (No.1 10m Semi Anechoic Chamber)	30MHz-200MHz, 3m, Horizontal	±4.5dB
	200MHz-1000MHz, 3m, Horizontal	±4.1dB
	30MHz-200MHz, 3m, Vertical	±4.4dB
	200MHz-1000MHz, 3m, Vertical	±4.4dB
	30MHz-200MHz, 10m, Horizontal	±4.4dB
	200MHz-1000MHz, 10m, Horizontal	±3.9dB
	30MHz-200MHz, 10m, Vertical	±4.4dB
	200MHz-1000MHz, 10m, Vertical	±4.1dB
	1GHz-6GHz, 3m	±4.7dB
	6GHz-18GHz, 3m	±4.4dB
Radiated emissions (No.2 10m Semi Anechoic Chamber)	30MHz-200MHz, 3m, Horizontal	±4.1dB
	200MHz-1000MHz, 3m, Horizontal	±4.0dB
	30MHz-200MHz, 3m, Vertical	±4.5dB
	200MHz-1000MHz, 3m, Vertical	±4.4dB
	30MHz-200MHz, 10m, Horizontal	±4.1dB
	200MHz-1000MHz, 10m, Horizontal	±3.8dB
	30MHz-200MHz, 10m, Vertical	±4.4dB
	200MHz-1000MHz, 10m, Vertical	±4.2dB
	1GHz-6GHz, 3m	±4.8dB
	6GHz-18GHz, 3m	±4.4dB

Test Items/Facilities	Frequency/Equipment/Unit	Uncertainty
Radiated emissions (No.1 3m Semi Anechoic Chamber)	30MHz-200MHz, 3m, Horizontal	±3.8dB
	200MHz-1000MHz, 3m, Horizontal	±4.1dB
	30MHz-200MHz, 3m, Vertical	±4.5dB
	200MHz-1000MHz, 3m, Vertical	±4.5dB
	1GHz-6GHz, 3m	±4.7dB
	6GHz-18GHz, 3m	±4.1dB
Radiated emissions (No.2 3m Semi Anechoic Chamber)	30MHz-200MHz, 3m, Horizontal	±3.6dB
	200MHz-1000MHz, 3m, Horizontal	±3.9dB
	30MHz-200MHz, 3m, Vertical	±4.1dB
	200MHz-1000MHz, 3m, Vertical	±4.6dB
	1GHz-6GHz, 3m	±4.8dB
	6GHz-18GHz, 3m	±4.2dB
Radiated emissions (No.3 3m Semi Anechoic Chamber)	30MHz-200MHz, 3m, Horizontal	±3.9dB
	200MHz-1000MHz, 3m, Horizontal	±4.2dB
	30MHz-200MHz, 3m, Vertical	±4.3dB
	200MHz-1000MHz, 3m, Vertical	±4.5dB
Radiated emissions (No.4 3m Semi Anechoic Chamber)	30MHz-200MHz, 3m, Horizontal	±4.1dB
	200MHz-1000MHz, 3m, Horizontal	±4.5dB
	30MHz-200MHz, 3m, Vertical	±4.4dB
	200MHz-1000MHz, 3m, Vertical	±4.8dB
	1GHz-6GHz, 3m	±5.0dB
	6GHz-18GHz, 3m	±4.7dB
Radiated emissions (No.5 3m Semi Anechoic Chamber)	30MHz-200MHz, 3m, Horizontal	±4.2dB
	200MHz-1000MHz, 3m, Horizontal	±4.3dB
	30MHz-200MHz, 3m, Vertical	±4.3dB
	200MHz-1000MHz, 3m, Vertical	±4.7dB
	1GHz-6GHz, 3m	±4.8dB
	6GHz-18GHz, 3m	±4.5dB

Test Items/Facilities	Frequency/Equipment/Unit	Uncertainty
Radiated emissions (No.6 Open Area Test Site)	30MHz-200MHz, 3m, Horizontal	±3.6dB
	200MHz-1000MHz, 3m, Horizontal	±4.1dB
	30MHz-200MHz, 3m, Vertical	±3.6dB
	200MHz-1000MHz, 3m, Vertical	±4.1dB
	30MHz-200MHz, 10m, Horizontal	±3.6dB
	200MHz-1000MHz, 10m, Horizontal	±3.9dB
	30MHz-200MHz, 10m, Vertical	±3.6dB
	200MHz-1000MHz, 10m, Vertical	±3.9dB
Radiated emissions (No.7 Open Area Test Site)	30MHz-200MHz, 3m, Horizontal	±4.0dB
	200MHz-1000MHz, 3m, Horizontal	±4.3dB
	30MHz-200MHz, 3m, Vertical	±4.4dB
	200MHz-1000MHz, 3m, Vertical	±4.7dB
	30MHz-200MHz, 10m, Horizontal	±4.0dB
	200MHz-1000MHz, 10m, Horizontal	±4.2dB
	30MHz-200MHz, 10m, Vertical	±4.4dB
	200MHz-1000MHz, 10m, Vertical	±4.5dB
Radiated emissions (No.8 Open Area Test Site)	30MHz-200MHz, 3m, Horizontal	±4.3dB
	200MHz-1000MHz, 3m, Horizontal	±4.8dB
	30MHz-200MHz, 3m, Vertical	±4.5dB
	200MHz-1000MHz, 3m, Vertical	±4.8dB
	30MHz-200MHz, 10m, Horizontal	±4.3dB
	200MHz-1000MHz, 10m, Horizontal	±4.7dB
	30MHz-200MHz, 10m, Vertical	±4.5dB
	200MHz-1000MHz, 10m, Vertical	±4.6dB

## 8. Photographs

### 8.1. Powerline Conducted Emission Measurement



Front View of Conducted Measurement



Back View of Conducted Measurement



## 8.2. Radiated Emissions Measurement

- For Frequency Range 30 – 1000MHz



Front View of Radiated Measurement



Back View of Radiated Measurement

- For Frequency Range Above 1GHz

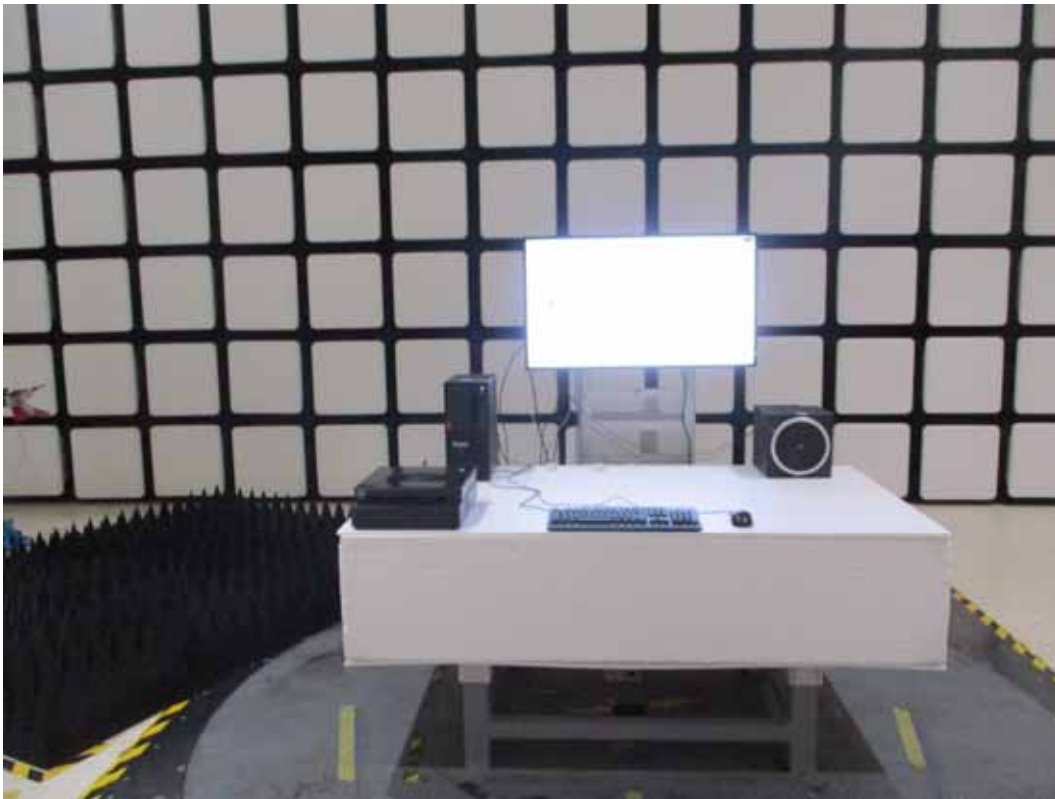

Front View of Radiated Measurement

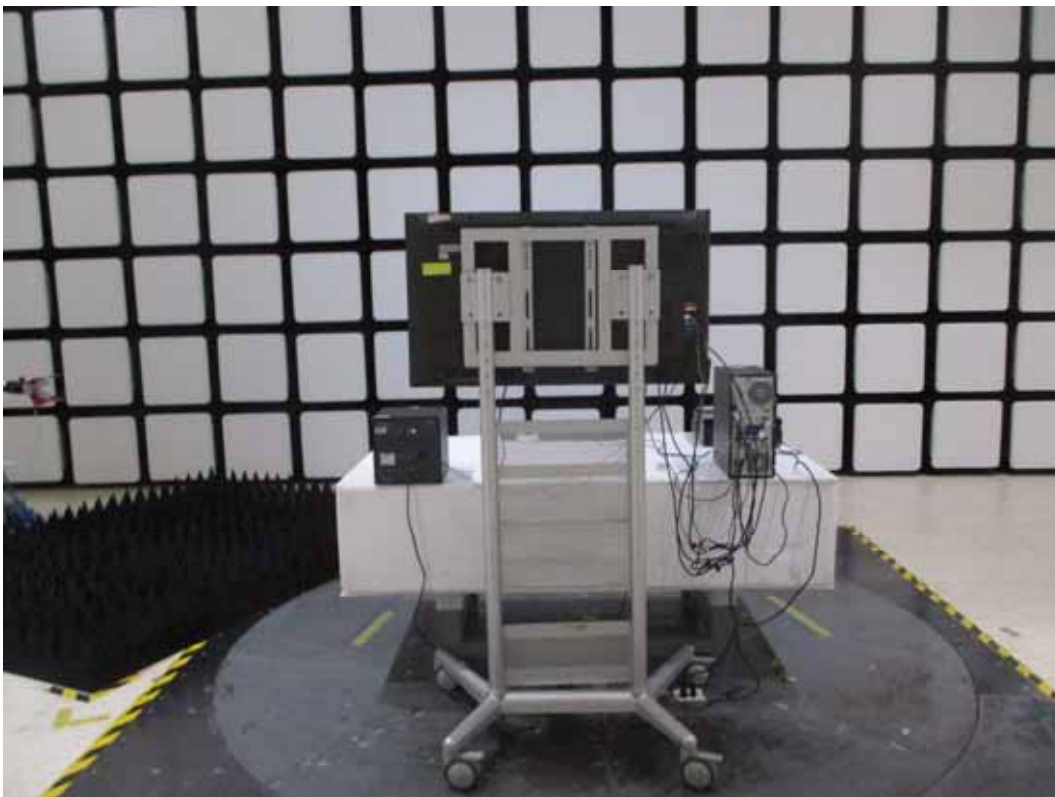

Back View of Radiated Measurement