

## X754HB Installation Guide

### 75" LCD Display

Rev 1.0

#### Contents:

Product Description and Notes	Page 1
Tilt Angle and Rotation	Page 1
Ventilation Recommendations	Page 2
Display Dimensions	Page 3-4
Display Dimensions with stand	Page 5
Optional Table Top Stand Dimensions	Page 6
Optional Speaker Dimensions	Page 7-8
Dimensions of Optional Wall Mount (WMK-6598)	Page 9
Input Terminals	Page 10
Control Codes	Page 10
Browser Control	Page 11



#### Product Description:

Type:	LCD Display	Dimensions without stand:	66.7" (W) x 38.3" (H) x 5.9" (D)
Resolution:	1920 x 1080	Dimensions with stand:	66.7" x 39.7"(H) x 23.9"(D)
Aspect Ratio:	16:9	Weight without stand:	127.7 lbs
FCC:	Class A	Weight with stand:	138.8 lbs
Power Consumption:	540W (typ) 940W (abs max)		
BTU's:	1842.56 BTU/hour 3207.41 BTU/hr		

#### NOTES:

- This document is intended to be used as a reference guide to supply useful information for a design or installation. It is not intended to be a step-by step procedure for installation.
- Any ceilings or walls must be strong enough to support the monitor and the installation must be in accordance with any local building codes. All mounts should make secure contact to wood studs.
- 4:3 sources can be displayed on the 16:9 screen in either normal aspect ratio with bars on the left or right, or stretched horizontally to fill the screen using the menus (see "Aspect Modes" in menus and user manual).
- Distances are in inches, for millimeters multiply by 25.4.
- Distances may vary  $\pm 5\%$ .

#### Tilt Angle and Rotation:

- Below is the maximum angle the monitor can be tilted. Note that the monitor can only be tilted in the landscape position.

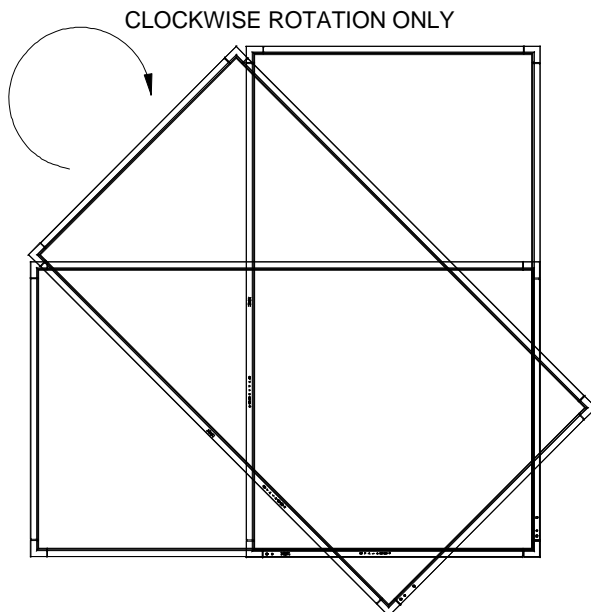

#### MAXIMUM TILT ANGLE

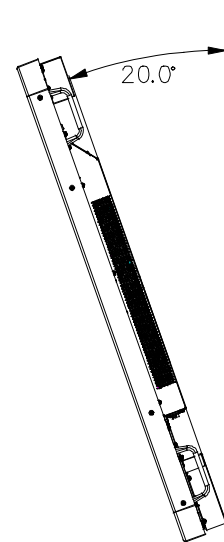

## X754HB Installation Guide

75" LCD Display

Rev 1.0

### Ventilation Recommendations:

Dimensions below are minimum required for proper ventilation.

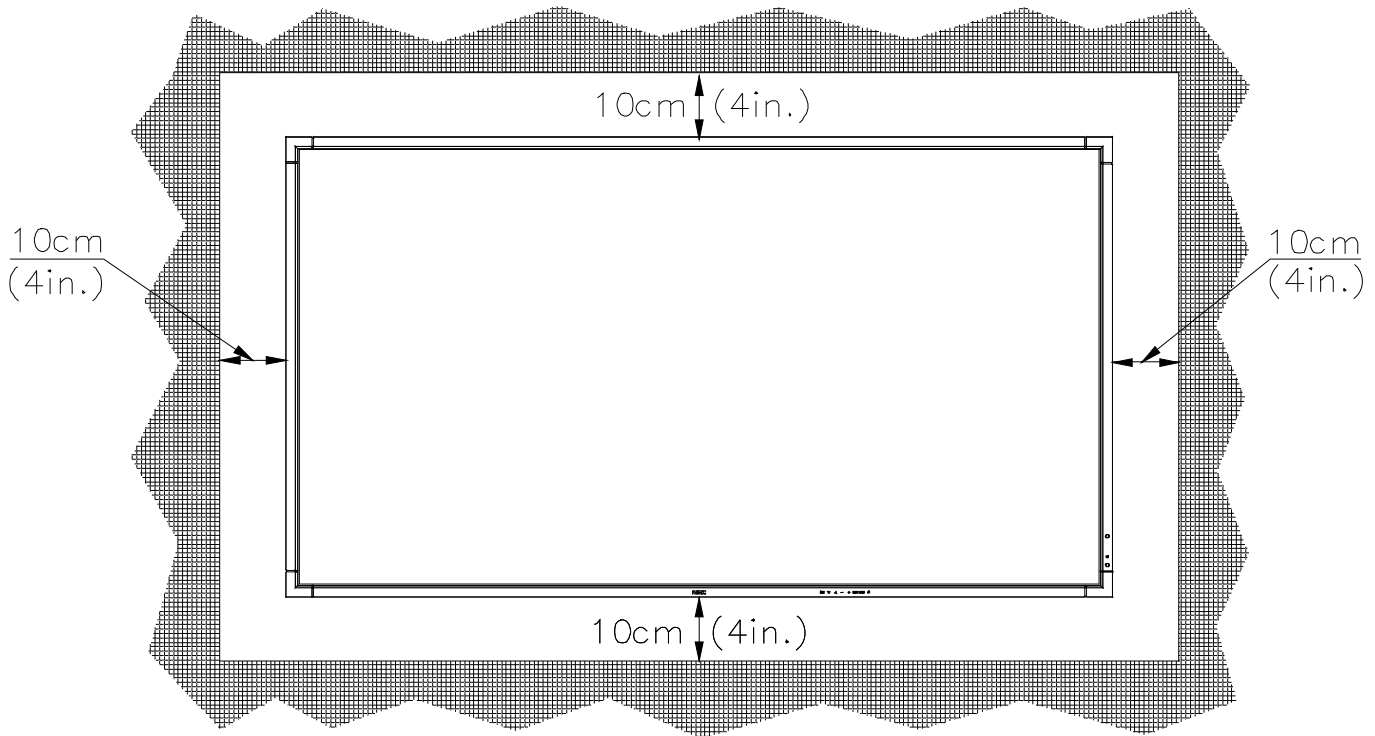

**NOTE:**

- The ventilation space should not be covered or closed off at the front of the opening. If for some reason the opening needs to be covered, other means of ventilation will need to be incorporated into the design. Contact NEC for design review and recommendations.

## X754HB Installation Guide

75" LCD Display

Rev 1.0

### Display dimensions:

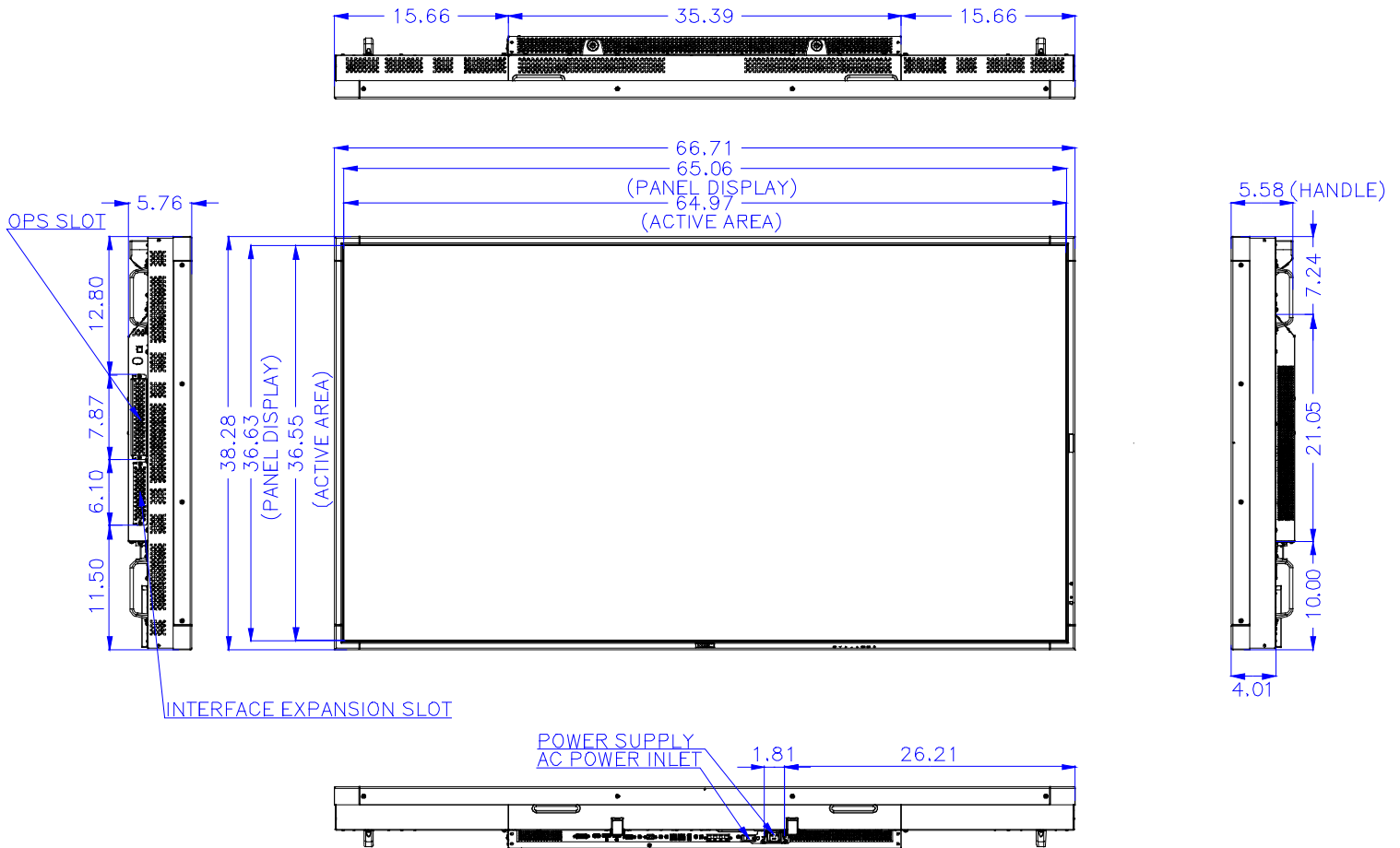

## X754HB Installation Guide

75" LCD Display

Rev 1.0

### Display dimensions (cont.):

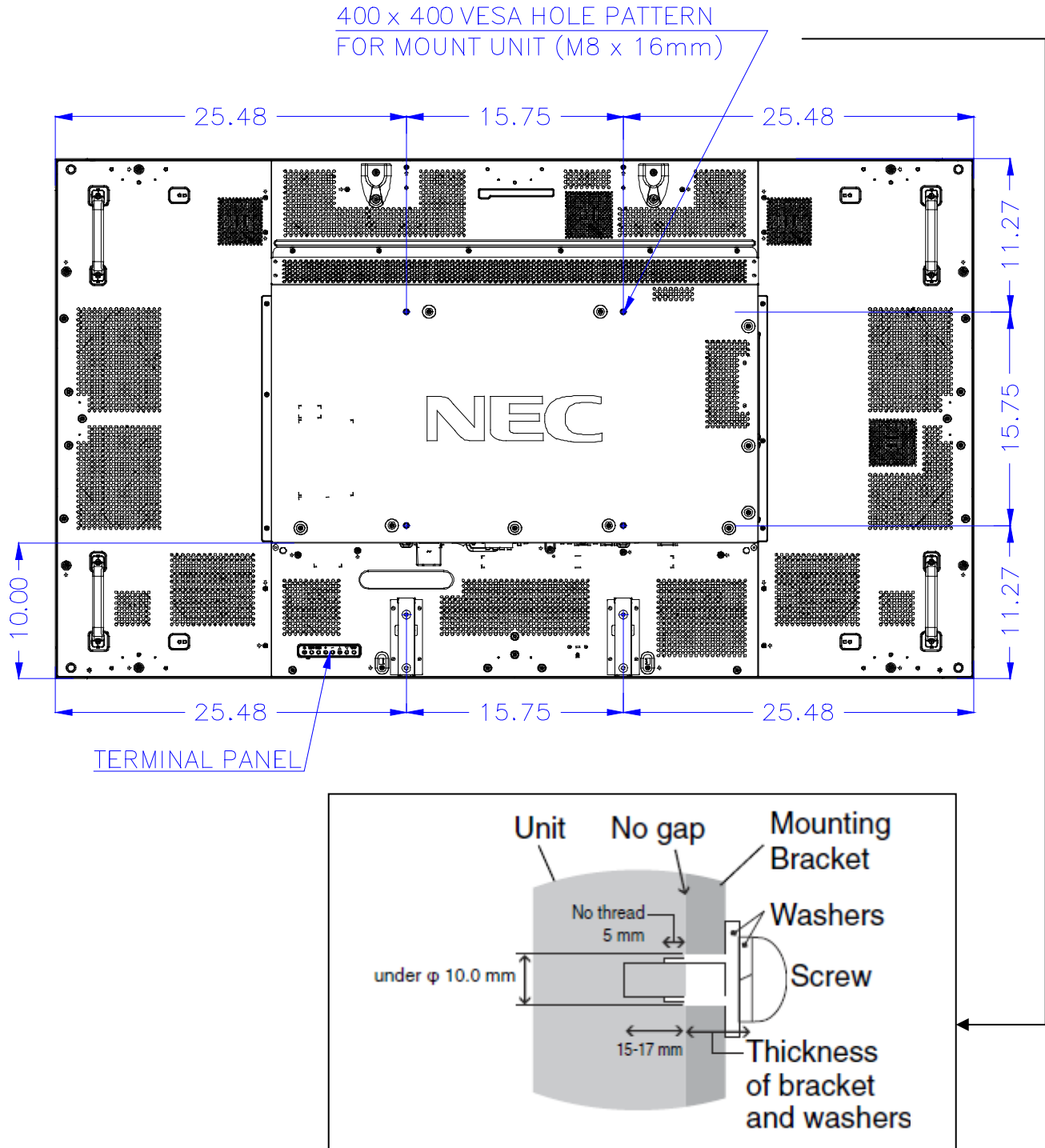

## X754HB Installation Guide

75" LCD Display

Rev 1.0

### Display Dimensions (with ST-801 stand):

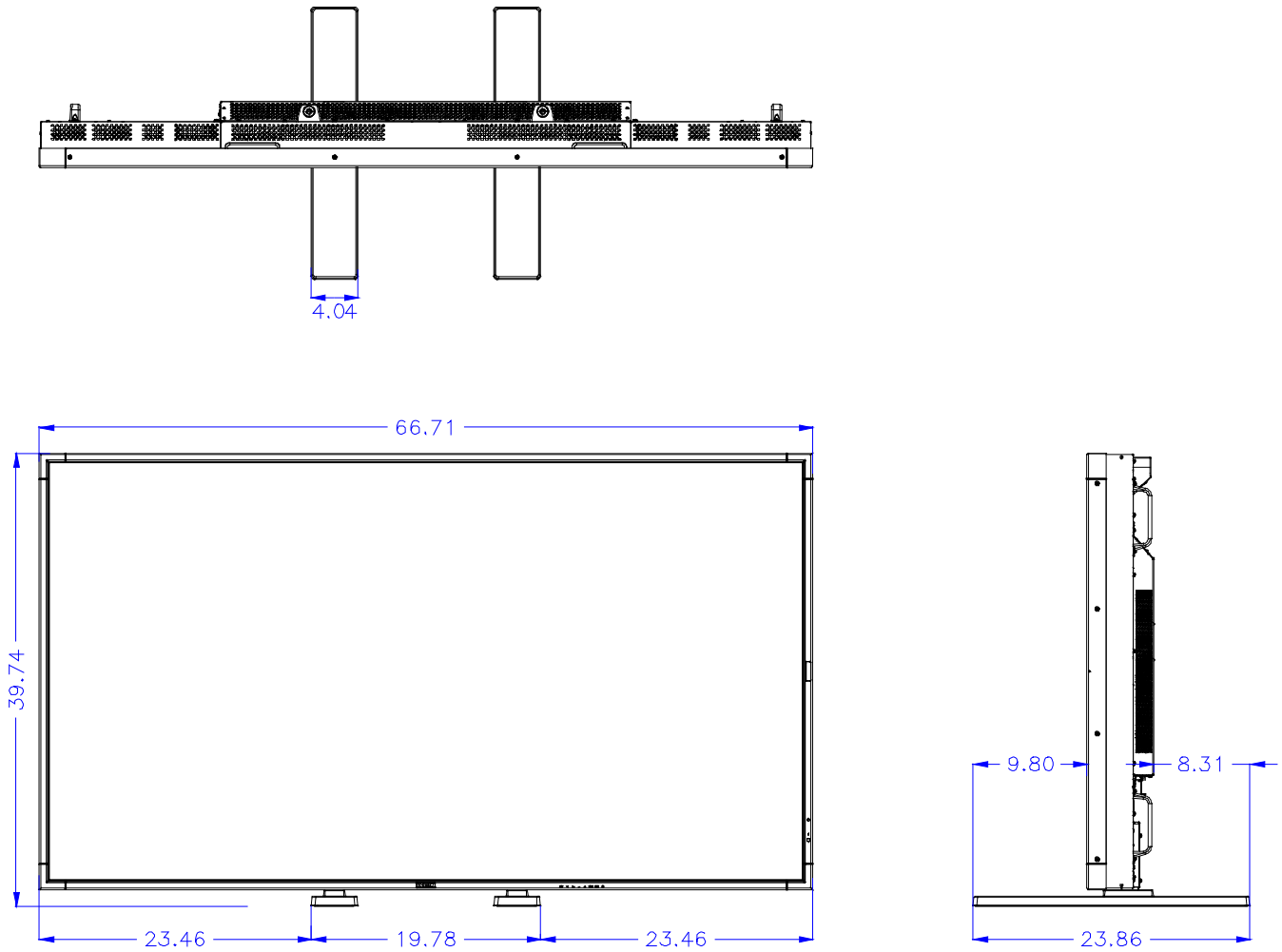

## X754HB Installation Guide

75" LCD Display

Rev 1.0

### Table Top Stand Dimensions (ST-801):

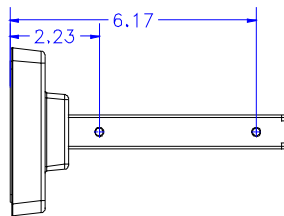
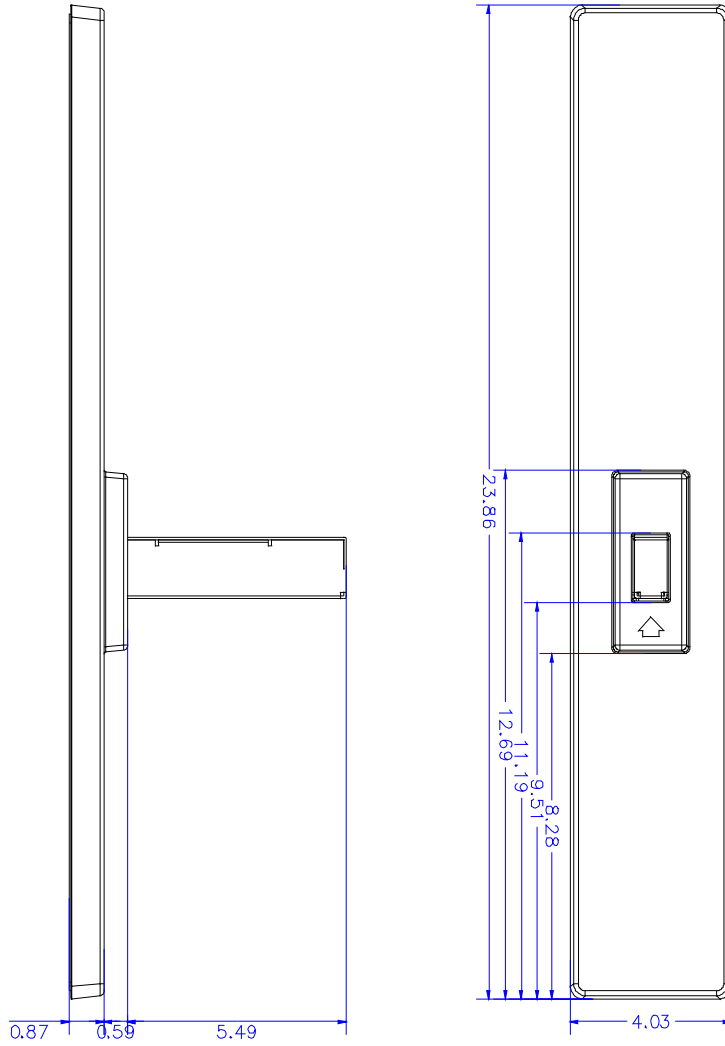

## X754HB Installation Guide

75" LCD Display

Rev 1.0

### Dimensions of Optional Front-Firing Speaker (SP-TF1)

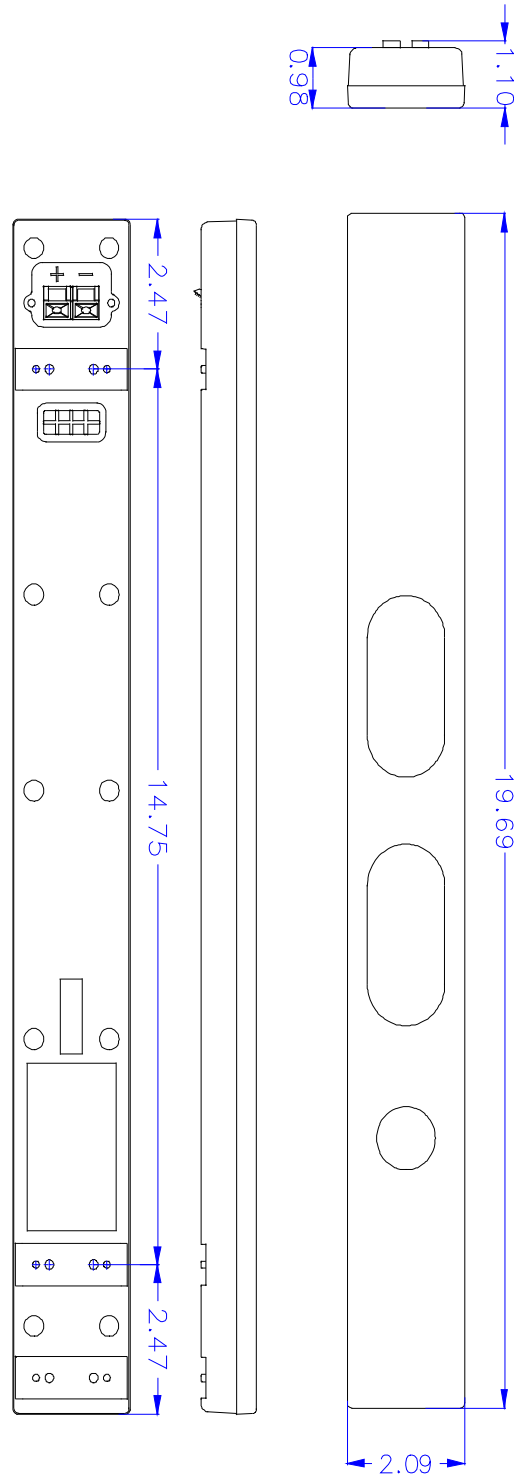

## X754HB Installation Guide

75" LCD Display

Rev 1.0

### Optional Side-Firing Speaker Dimensions including holder (SP-RM1):

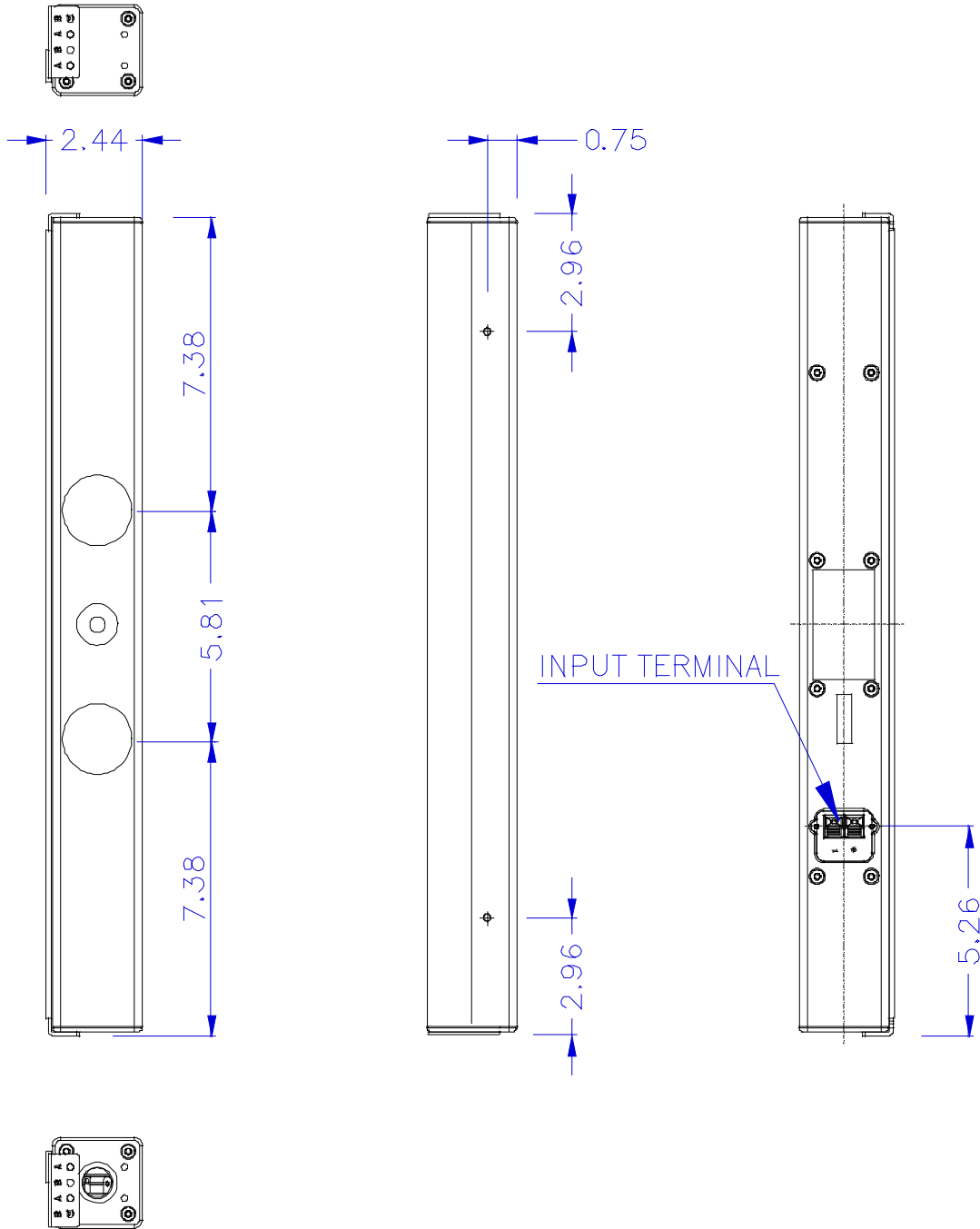



## X754HB Installation Guide

75" LCD Display

Rev 1.0

### Dimensions with Optional Wall Mount Kit (WMK-6598):

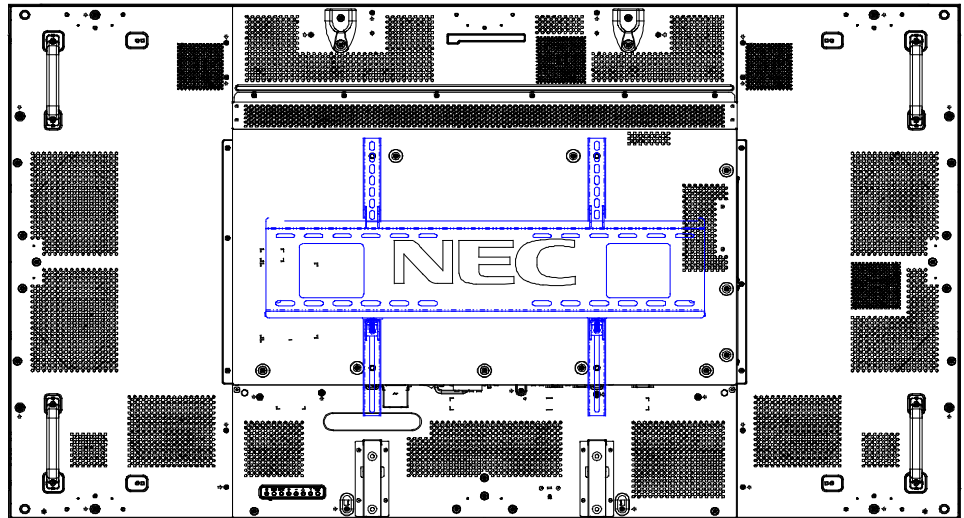
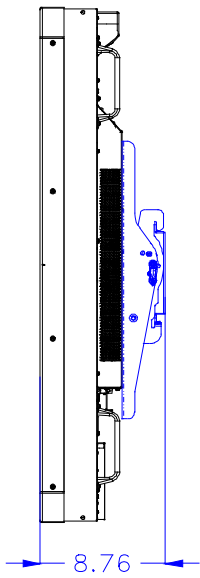

## X754HB Installation Guide

75" LCD Display

Rev 1.0

### Input Panels:

Bottom:



### Control Codes:

Function (Monitor ID = 1)	Code Data
Power ON	01 30 41 30 41 30 43 02 43 32 30 33 44 36 30 30 30 31 03 73 0d
Power OFF	01 30 41 30 41 30 43 02 43 32 30 33 44 36 30 30 30 34 03 76 0d
Input Source Select DisplayPort	01 30 41 30 45 30 41 02 30 30 36 30 30 30 30 46 03 04 0d
Input Source Select DVI	01 30 41 30 45 30 41 02 30 30 36 30 30 30 30 33 03 71 0d
Input Source Select VGA	01 30 41 30 45 30 41 02 30 30 36 30 30 30 30 31 03 73 0d
Input Source Select HDMI	01 30 41 30 45 30 41 02 30 30 36 30 30 30 31 31 03 72 0d
Input Source Select Y/Pb/Pr	01 30 41 30 45 30 41 02 30 30 36 30 30 30 30 43 03 01 0d
Input Source Select OPTION	01 30 41 30 45 30 41 02 30 30 36 30 30 30 30 44 03 06 0d
Sound Mute ON	01 30 41 30 45 30 41 02 30 30 38 44 30 30 30 31 03 09 0d
Sound Mute OFF	01 30 41 30 45 30 41 02 30 30 38 44 30 30 30 32 03 0a 0d

**NOTE:** Contact your NEC rep for codes not listed.

**NOTE:** Use a cross/reverse/null modem cable.

### Cable Connection:

#### Communication Protocol:

Interface: RS-232C  
 Communication System: Asynchronous  
 Baud Rate: 9600 bps  
 Data Length: 8 bits  
 Parity: None  
 Stop Bit: 1 bit  
 Communication Code: ASCII

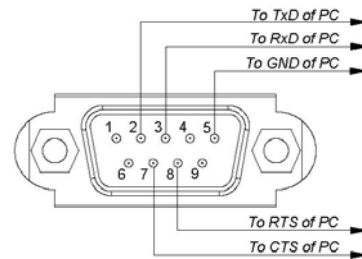

Interface: Ethernet (CSMA/CD)  
 Communication System: TCP/IP (Internet Protocol Suite)  
 Communication Layer: Transport layer (TCP)  
 IP Address: 192.168.0.10 (default out of box)  
 Port Number: 7142 (Fixed)

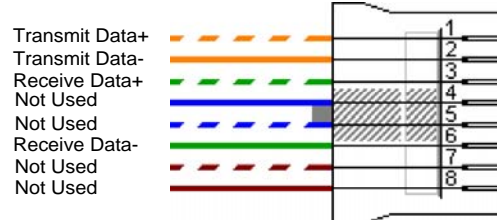

**NOTE:** If so desired, jumper "Request to send" and "Clear to Send" together on both ends of the cable to simplify cable connection. These connections are not required. The only connections required are pins 2 (TxD), 3 (RxD) and 5 (GND).

## X754HB Installation Guide

75" LCD Display

Rev 1.0

### Browser Control

Information and control can also be available through the HTTP browser control menu.

In order to accomplish this, type: **http://<the Monitor's IP address>/pd\_index.html**

Note that the LAN Power needs to be turned on in order for the display to be controlled while the units are off.

All displays are set to the IP address 192.168.0.10 out of the box

Communicating network PC needs to be on the same subnet as display that is being communicated with

### NEC P553 OPTION

[HOME](#)

[REMOTE CONTROL](#)

[PICTURE](#)

[ADJUST](#)

[AUDIO](#)

[SCHEDULE](#)

[PIP](#)

[OSD](#)

[MULTI DISPLAY](#)

[DISPLAY PROTECTION](#)

[EXTERNAL CONTROL](#)

[ADVANCED OPTION1](#)

[ADVANCED OPTION2](#)

[NETWORK](#)

[MAIL](#)

[SNMP](#)

[AMX](#)

[CRESTRON](#)

[NAME](#)

[NETWORK PASSWORD](#)

[PD LIST](#)

[MEMO](#)

[UPDATE FIRMWARE](#)

#### HOME

Welcome to the management and configuration web interface.  
You can use the navigation menus on the left to access additional pages.

#### MONITOR INFORMATION

MODEL NAME	P553
SERIAL	3Y000304NA

#### FIRMWARE VERSION

FIRMWARE1	1.031ED
FIRMWARE2	1.006

#### ETHERNET

MAC ADDRESS	58:C2:32:DC:F8:BA
IPv4 ADDRESS	192.168.0.14
SUBNET MASK	255.255.255.0
DEFAULT GATEWAY	0.0.0.0
DNS PRIMARY	0.0.0.0
DNS SECONDARY	0.0.0.0

#### ID

MONITOR ID	1
GROUP ID	

Copyright © NEC Display Solutions, Ltd. 2013. All rights reserved.

#### NOTE:

Menus on the left side of the above screenshot can be altered to control the display  
Menu above is consistent with the X754HB though it states P553 on top