

X464UN Installation Guide

46" LED LCD Display

Rev 1.0

Contents

Product Description and Notes	Page 1
Tilt Angle and Rotation	Page 1
Ventilation Requirements	Page 2
Display Dimensions	
Front and all Sides	Page 3
Back	Page 4
TMX4P and TMX9P Outer Dimensions	Page 5
Input Panel	Page 5
Control Codes	Page 6
Cable Connections	Page 6
Browser Control	Page 7



Product Description

Type:	LCD Display	Screen Surface:	Anti-Reflective
Resolution:	1920 x 1080	Dimensions:	40.31 x 22.78 x 3.92 in.
Quad Resolution:	3840 x 2160	Quad Dimensions:	80.63 x 45.56 x 3.92 in.
Aspect Ratio:	16:9	Weight:	50.7 lbs
FCC:	Class A	Quad Weight:	202.8 lbs
Power Consumption:	150W (max)	BTU's:	511.82 BTU/hour
Quad Power Consumption:	600W (max)	Quad BTU's:	2047.29 BTU/hour

NOTES:

- This document is intended to be used as a reference guide to supply useful information for a design or installation. It is not intended to be a step-by step procedure for installation.
- Any ceilings or walls must be strong enough to support the monitor and the installation must be in accordance with any local building codes. All mounts should make secure contact to wood studs.
- 4:3 sources can be displayed on the 16:9 screen in either normal aspect ratio with bars on the left or right, or stretched horizontally to fill the screen using the menus (see "Aspect Modes" in menus and user manual).
- Distances are in inches, for millimeters multiply by 25.4.
- Distances may vary $\pm 5\%$.

Tilt Angle and Rotation

Below are the maximum angles that the monitor can be tilted in the landscape position only.
Landscape 20deg

Max Tilt Angle

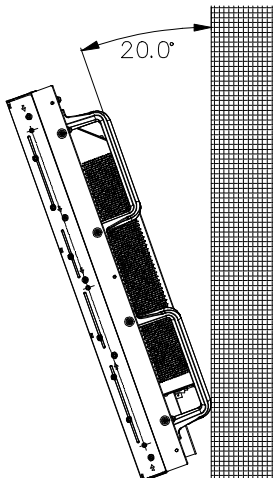

Clockwise Rotation Only

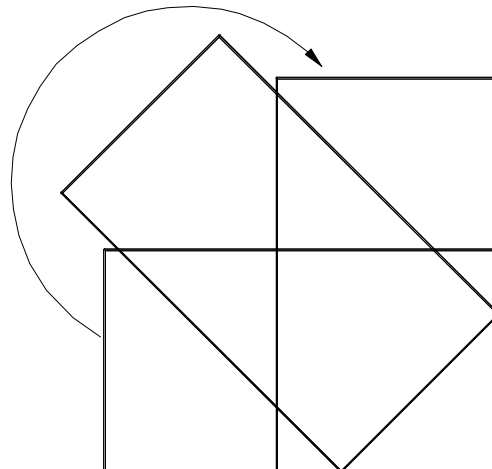

X464UN Installation Guide

46" LED LCD Display

Rev 1.0

Ventilation Requirements (all models)

Dimensions below are minimum required for proper ventilation.

Ventilation Requirements:
Landscape: 5° to 40° C
Portrait: 5 to 40° C
(41° to 104° F)

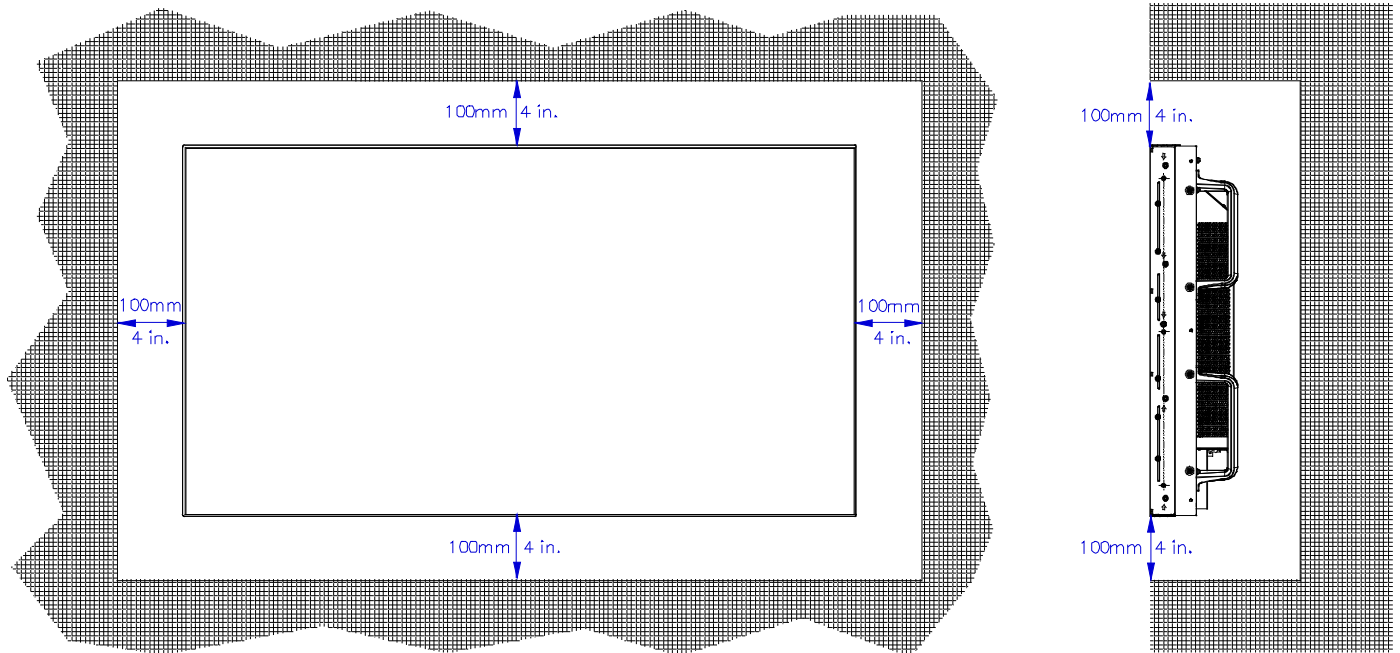

NOTE:

- The ventilation space should not be covered or closed off at the front of the opening. If for some reason the opening needs to be covered, other means of ventilation will need to be incorporated into the design. Contact NEC for design review and recommendations.

X464UN Installation Guide

46" LED LCD Display

Rev 1.0

Display dimensions

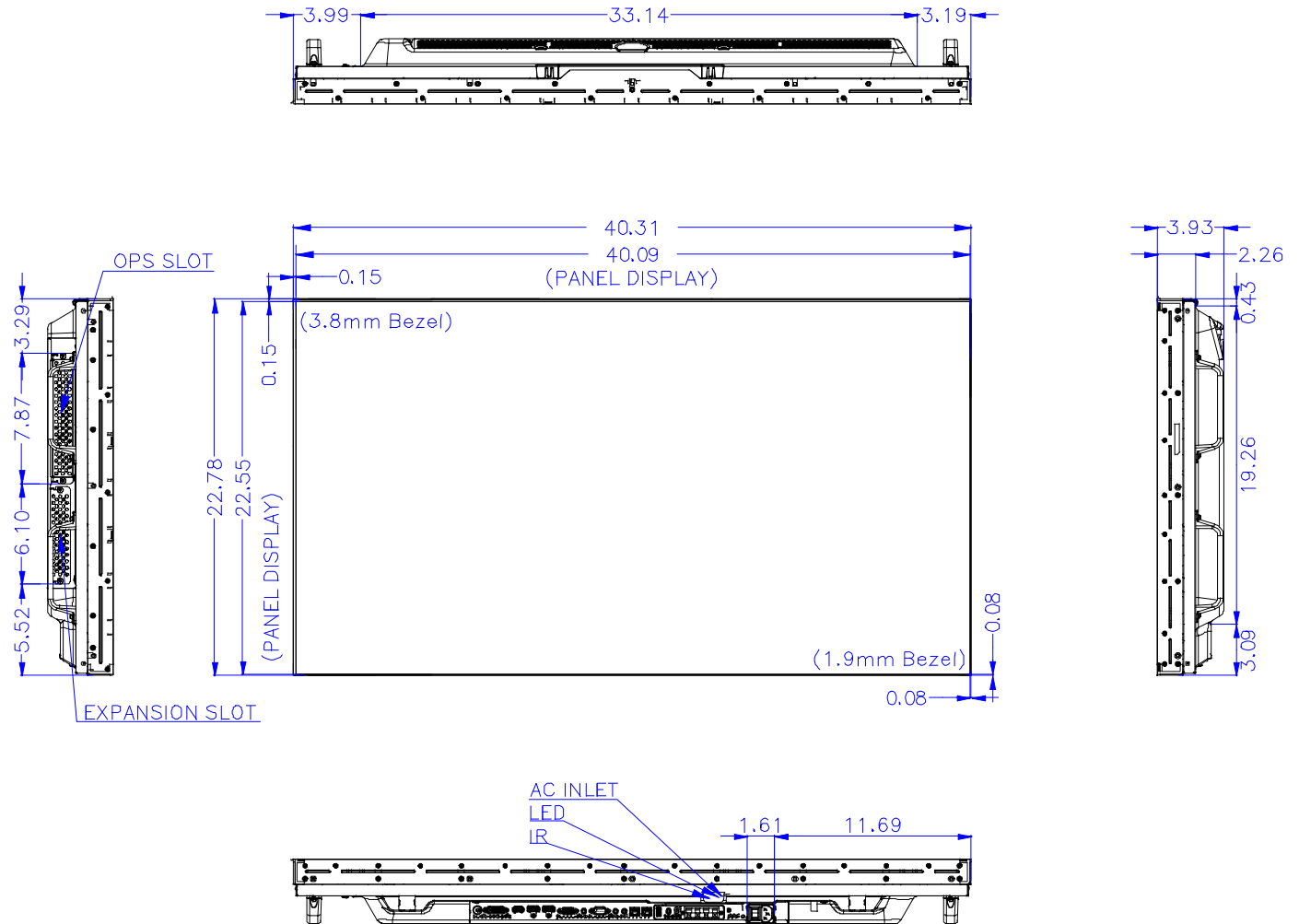

Note: This product is not symmetrical.

X464UN Installation Guide

46" LED LCD Display

Rev 1.0

Display dimensions (cont.)

300mm x 300mm VESA HOLE PATTERN
FOR MOUNT UNIT (M6 x 12mm)

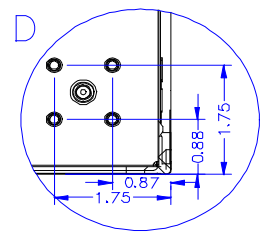
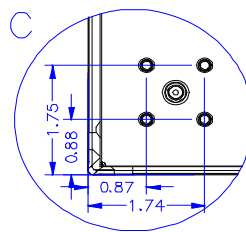
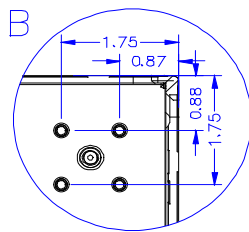
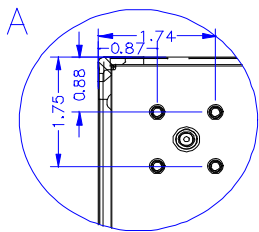
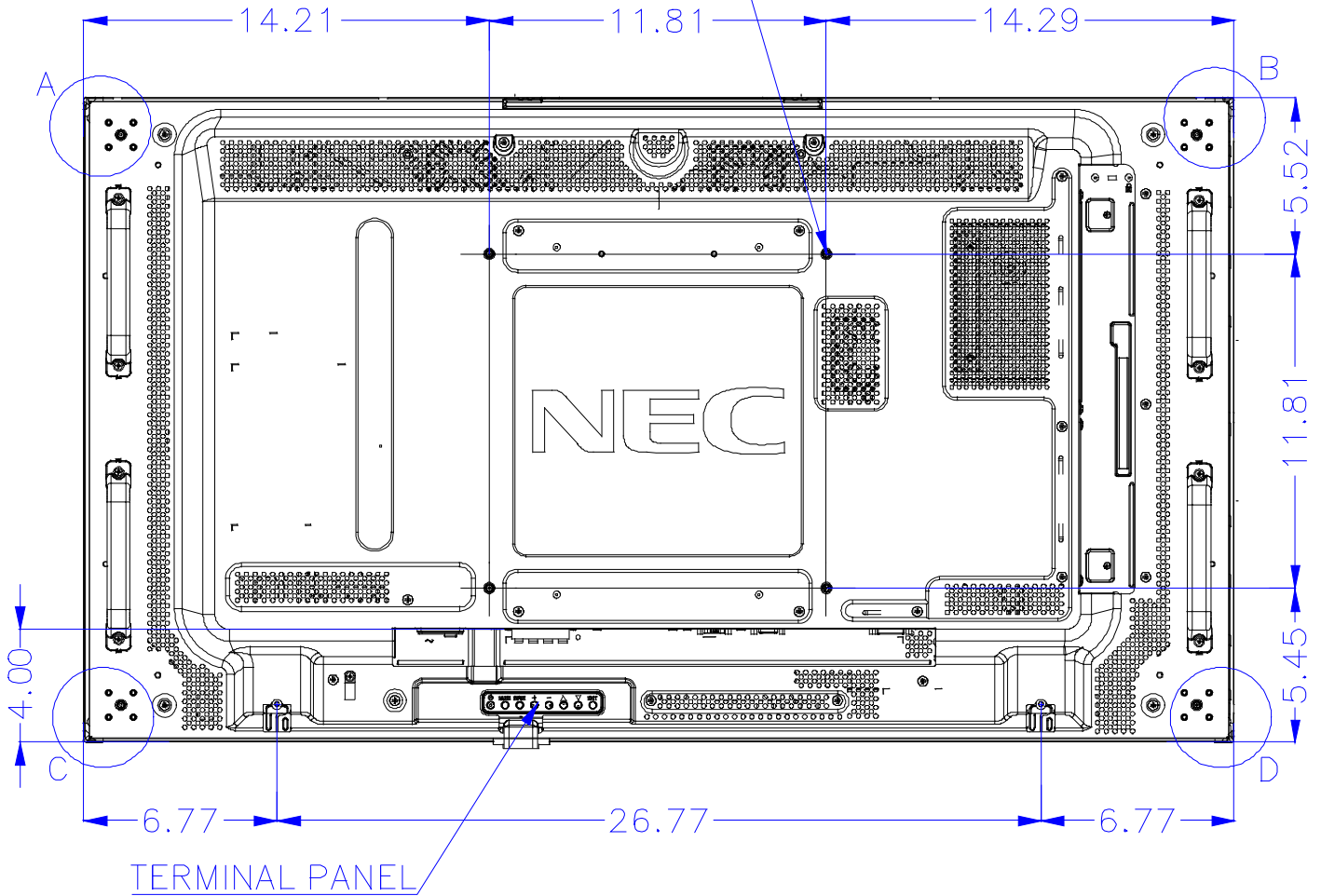

X464UN Installation Guide

46" LED LCD Display

Rev 1.0

X464UN-TMX4P and X464UN-TMX9P Outer Dimensions with Peerless DS-VW765-LAND

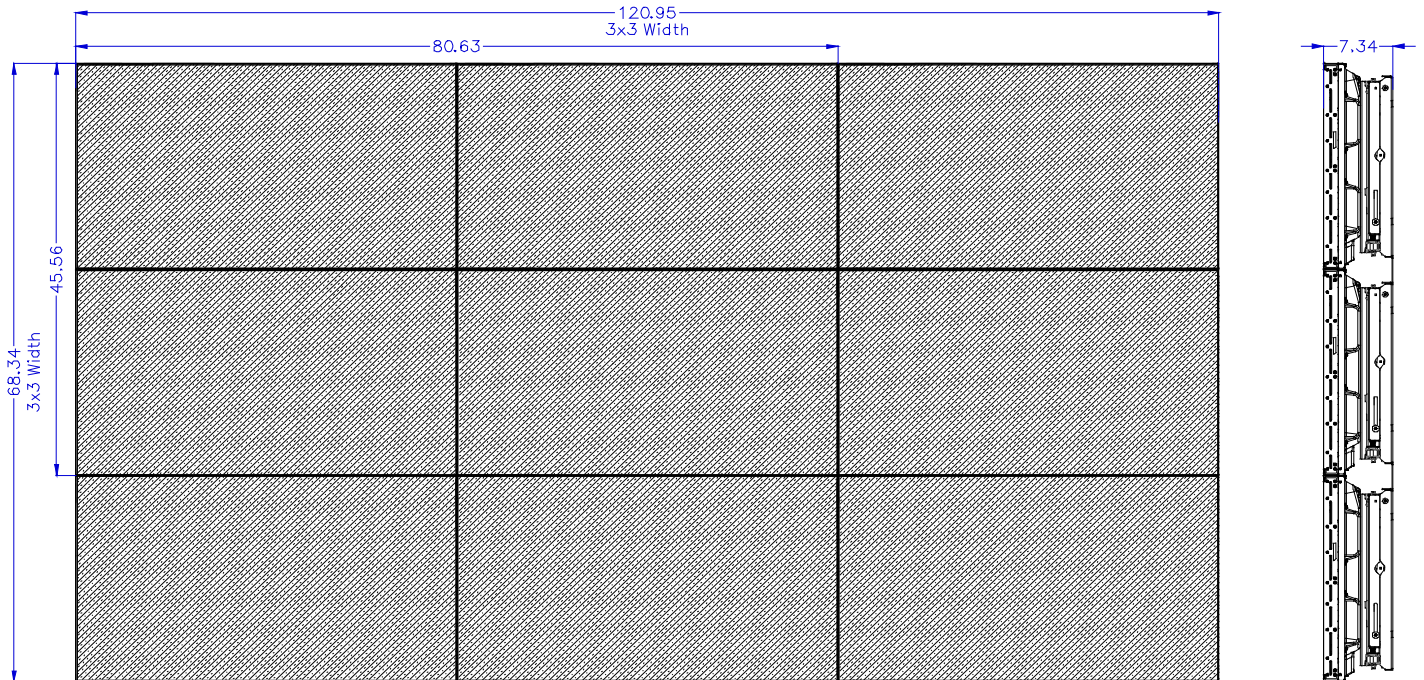

Note: KT-46UN-OF2 Overframe Bezel Kit not pictured

Input Panel (Bottom)



- Red circles in the above interface connections signify the IN of that particular connector. Blue circles in the above interface representations signify the OUT for that particular connector.

X464UN Installation Guide

46" LED LCD Display

Rev 1.0

Control Codes

Function (Monitor ID = 1)	Code Data
Power ON	01 30 41 30 41 30 43 02 43 32 30 33 44 36 30 30 30 31 03 73 0d
Power OFF	01 30 41 30 41 30 43 02 43 32 30 33 44 36 30 30 30 34 03 76 0d
Input Source Select DisplayPort	01 30 41 30 45 30 41 02 30 30 36 30 30 30 30 46 03 04 0d
Input Source Select DVI	01 30 41 30 45 30 41 02 30 30 36 30 30 30 30 33 03 71 0d
Input Source Select VGA	01 30 41 30 45 30 41 02 30 30 36 30 30 30 30 31 03 73 0d
Input Source Select HDMI	01 30 41 30 45 30 41 02 30 30 36 30 30 30 31 31 03 72 0d
Input Source Select Y/Pb/Pr	01 30 41 30 45 30 41 02 30 30 36 30 30 30 30 43 03 01 0d
Input Source Select VIDEO	01 30 41 30 45 30 41 02 30 30 36 30 30 30 30 35 03 77 0d
Input Source Select S-VIDEO	01 30 41 30 45 30 41 02 30 30 36 30 30 30 30 37 03 75 0d
Input Source Select OPTION	01 30 41 30 45 30 41 02 30 30 36 30 30 30 30 44 03 06 0d
Sound Mute ON	01 30 41 30 45 30 41 02 30 30 38 44 30 30 30 31 03 09 0d
Sound Mute OFF	01 30 41 30 45 30 41 02 30 30 38 44 30 30 30 32 03 0a 0d

NOTE: Contact your NEC rep for codes not listed.

NOTE: Use a cross/reverse/null modem cable.

Cable Connection

Communication Protocol:

Interface: RS-232C
 Communication: Asynchronous
 Baud Rate: 9600 bps
 Data Length: 8 bits
 Parity: None
 Stop Bit: 1 bit
 Communication Code: Hex

Interface: TCP/IP (Ethernet)
 Communication Layer: Transport Layer (TCP)
 IP Address: 192.168.0.10 (Default)
 Port Number: 7142 (Fixed)

PC Control Connector (D-Sub 9P)

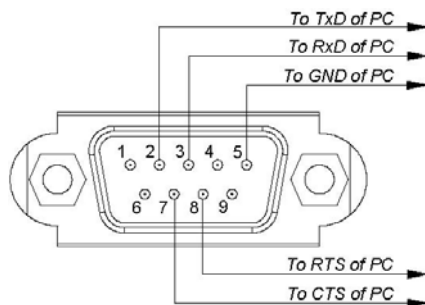

LAN Connector

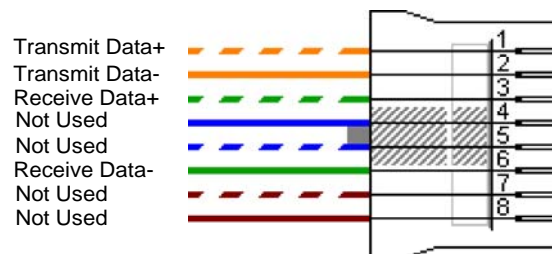

NOTE:

If so desired, jumper "Request to send" and "Clear to Send" together on both ends of the cable to simplify cable connection. These connections are not required. The only connections required are pins 2 (TxD), 3 (RxD) and 5 (GND)

X464UN Installation Guide

46" LED LCD Display

Browser Control

Information and control can also be available through the HTTP browser control menu.

In order to accomplish this, type: **http://<the Monitor's IP address>/pd_index.html**

Note that the LAN Power needs to be turned on in order for the display to be controlled while the units are off.

All displays are set to the IP address 192.168.0.10 out of the box

Communicating network PC needs to be on the same subnet as display that is being communicated with

NEC P553 OPTION

[HOME](#)

[REMOTE CONTROL](#)

[PICTURE](#)

[ADJUST](#)

[AUDIO](#)

[SCHEDULE](#)

[PIP](#)

[OSD](#)

[MULTI DISPLAY](#)

[DISPLAY PROTECTION](#)

[EXTERNAL CONTROL](#)

[ADVANCED OPTION1](#)

[ADVANCED OPTION2](#)

[NETWORK](#)

[MAIL](#)

[SNMP](#)

[AMX](#)

[CRESTRON](#)

[NAME](#)

[NETWORK PASSWORD](#)

[PD LIST](#)

[MEMO](#)

[UPDATE FIRMWARE](#)

HOME

Welcome to the management and configuration web interface.
You can use the navigation menus on the left to access additional pages.

MONITOR INFORMATION

MODEL NAME	P553
SERIAL	3Y000304NA

FIRMWARE VERSION

FIRMWARE1	1.031ED
FIRMWARE2	1.006

ETHERNET

MAC ADDRESS	58:C2:32:DC:F8:BA
IPv4 ADDRESS	192.168.0.14
SUBNET MASK	255.255.255.0
DEFAULT GATEWAY	0.0.0.0
DNS PRIMARY	0.0.0.0
DNS SECONDARY	0.0.0.0

ID

MONITOR ID	1
GROUP ID	

Copyright © NEC Display Solutions, Ltd. 2013. All rights reserved.

NOTE:

Menus on the left side of the above screenshot can be altered to control the display

Menu above is consistent with the X464UN even though it states P553 on top