

P461 Installation Guide

46" LCD Display

Rev 1.2

Contents:

Product Description and Notes	Page 1
Tilt Angle and Rotation	Page 1
Ventilation Requirements	Page 2
Display Dimensions	
Front, Top & Right Side	Page 3
Rear & Bottom	Page 4
Display Dimensions w/Optional Speakers and Stand	Page 5
Optional Table Top Stand Dimensions	Page 6
Optional Speaker Dimensions	Page 7
Dimensions with Optional Wall Mount	Page 8
Dimensions with Optional Wall Mount (WMK-3260L)	Page 8
Dimensions with Optional Wall Mount (WMK-3257)	Page 9
Input Panels	Page 10
Control Codes	Page 11

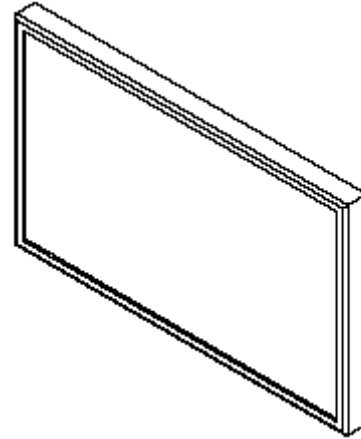

Product Description

Type: LCD Display
Resolution: 1920 x 1080
Aspect Ratio: 16:9
FCC: Class B
Power Consumption: 210W (max)
BTU's: 716.55 BTU/hour

Screen Surface: Anti-Reflective
Dimensions without stand: 41.6"(W) x 24.0"(H) x 5.5"(D)
Dimensions with stand: 41.6"(W) x 25.4"(H) x 13.8" (D)
Weight without stand: 62.8 lbs / 28.5 kg
Weight with stand: 66.8 lbs / 30.3 kg

NOTES:

- This document is intended to be used as a reference guide to supply useful information for a design or installation. It is not intended to be a step-by step procedure for installation.
- Any ceilings or walls must be strong enough to support the monitor and the installation must be in accordance with any local building codes. All mounts should make secure contact to wood studs.
- 4:3 sources can be displayed on the 16:9 screen in either normal aspect ratio with bars on the left or right, or stretched horizontally to fill the screen using the menus (see "Aspect Modes" in menus and user manual).
- Distances are in inches, for millimeters multiply by 25.4.

Tilt Angle and Rotation

Below are the maximum angles that the monitor can be tilted in the landscape position only.

Landscape 20deg

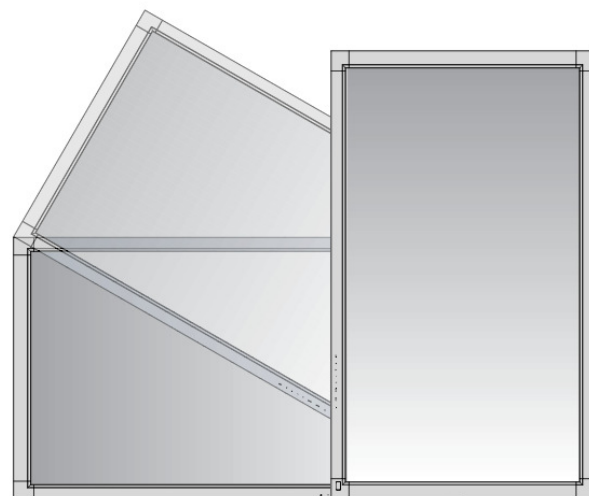
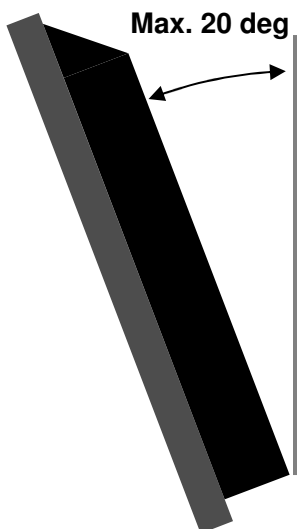

P461 Installation Guide

46" LCD Display

Rev 1.2

Ventilation Requirements (all models):

Dimensions below are minimum required for proper ventilation.

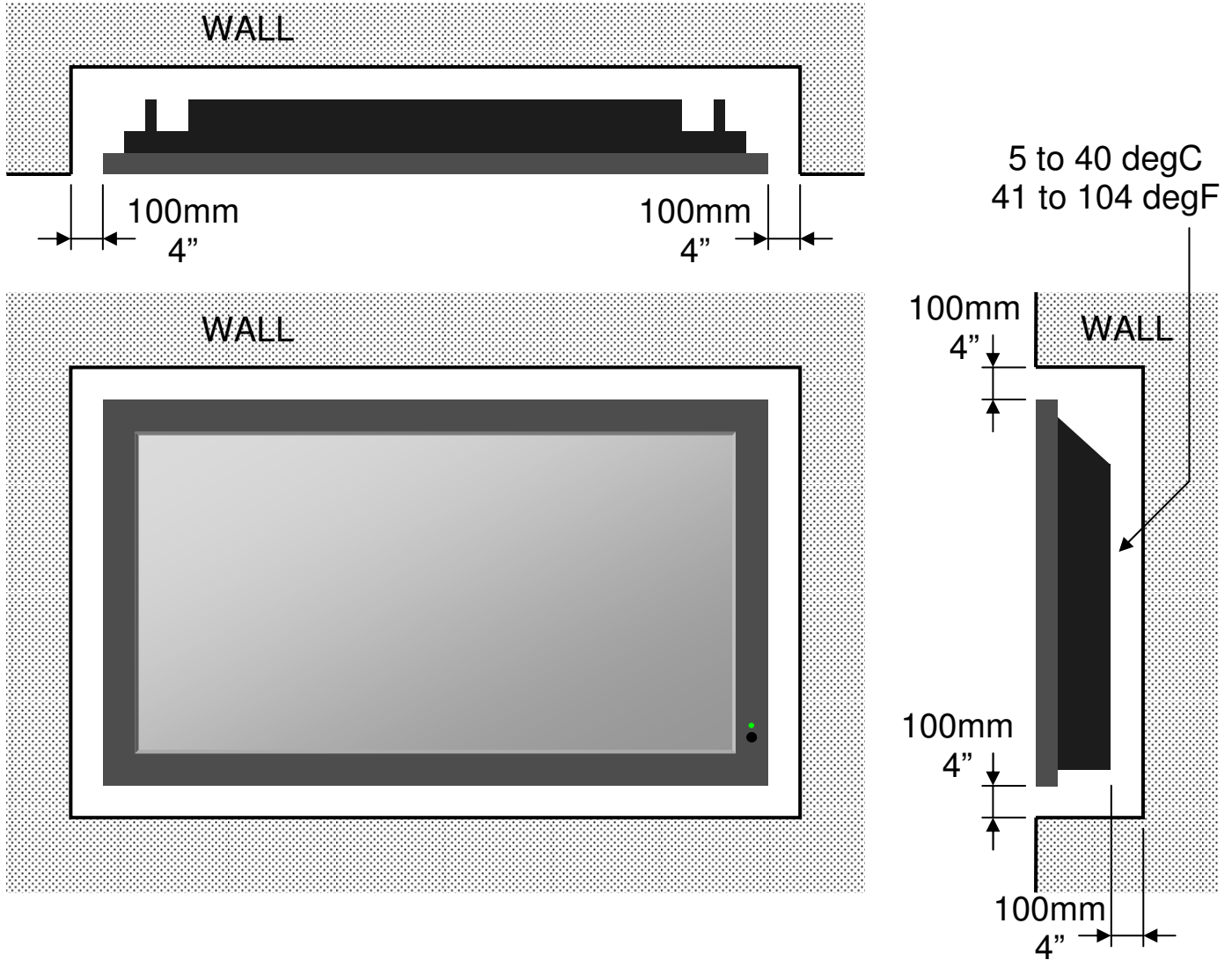

NOTE:

The ventilation space should not be covered or closed off at the front of the opening. If for some reason the opening needs to be covered, other means of ventilation will need to be incorporated into the design. Contact NEC for design review and recommendations.

P461 Installation Guide

46" LCD Display

Rev 1.2

Display dimensions:

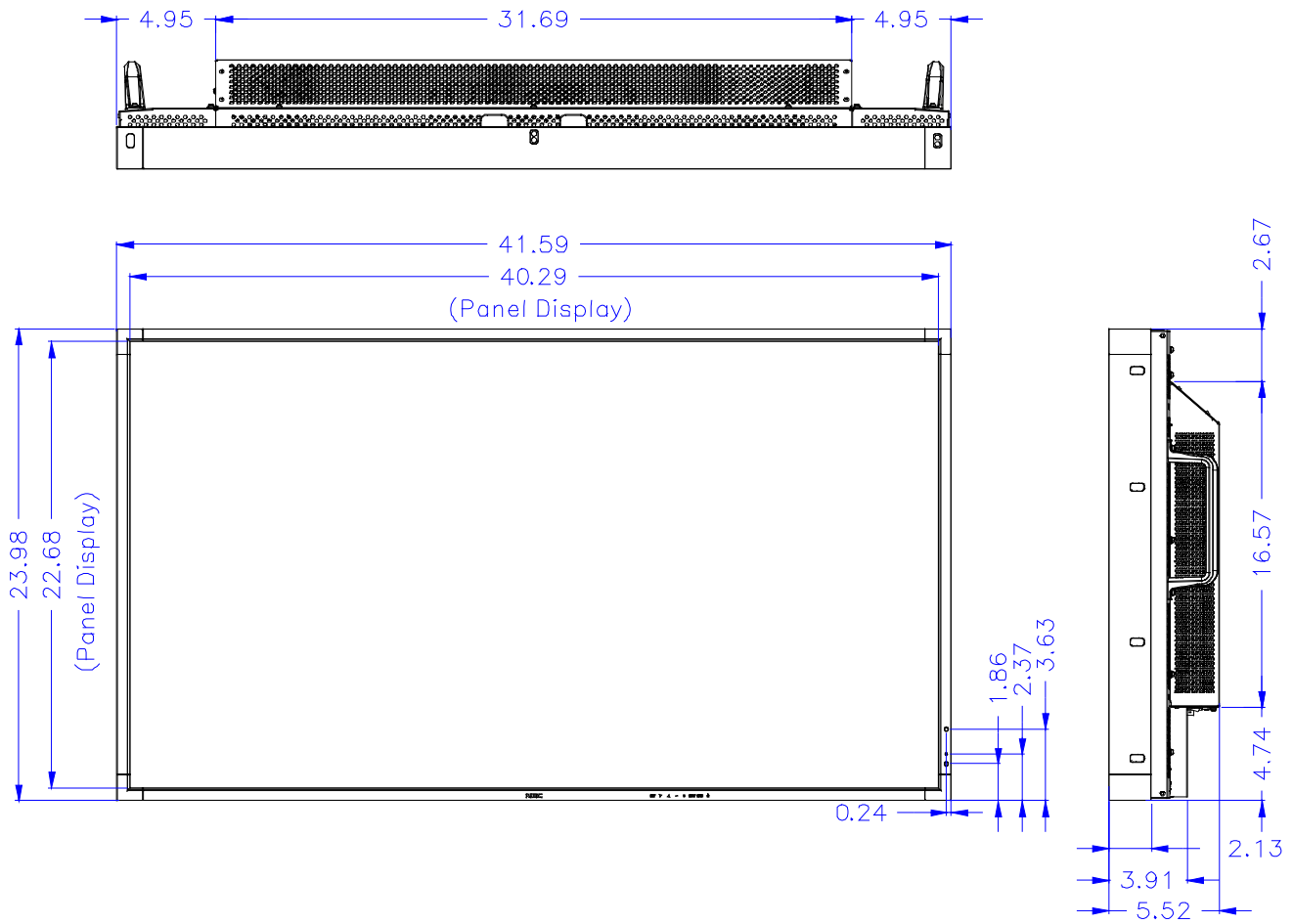

P461 Installation Guide

46" LCD Display

Rev 1.2

Display dimensions (cont.):

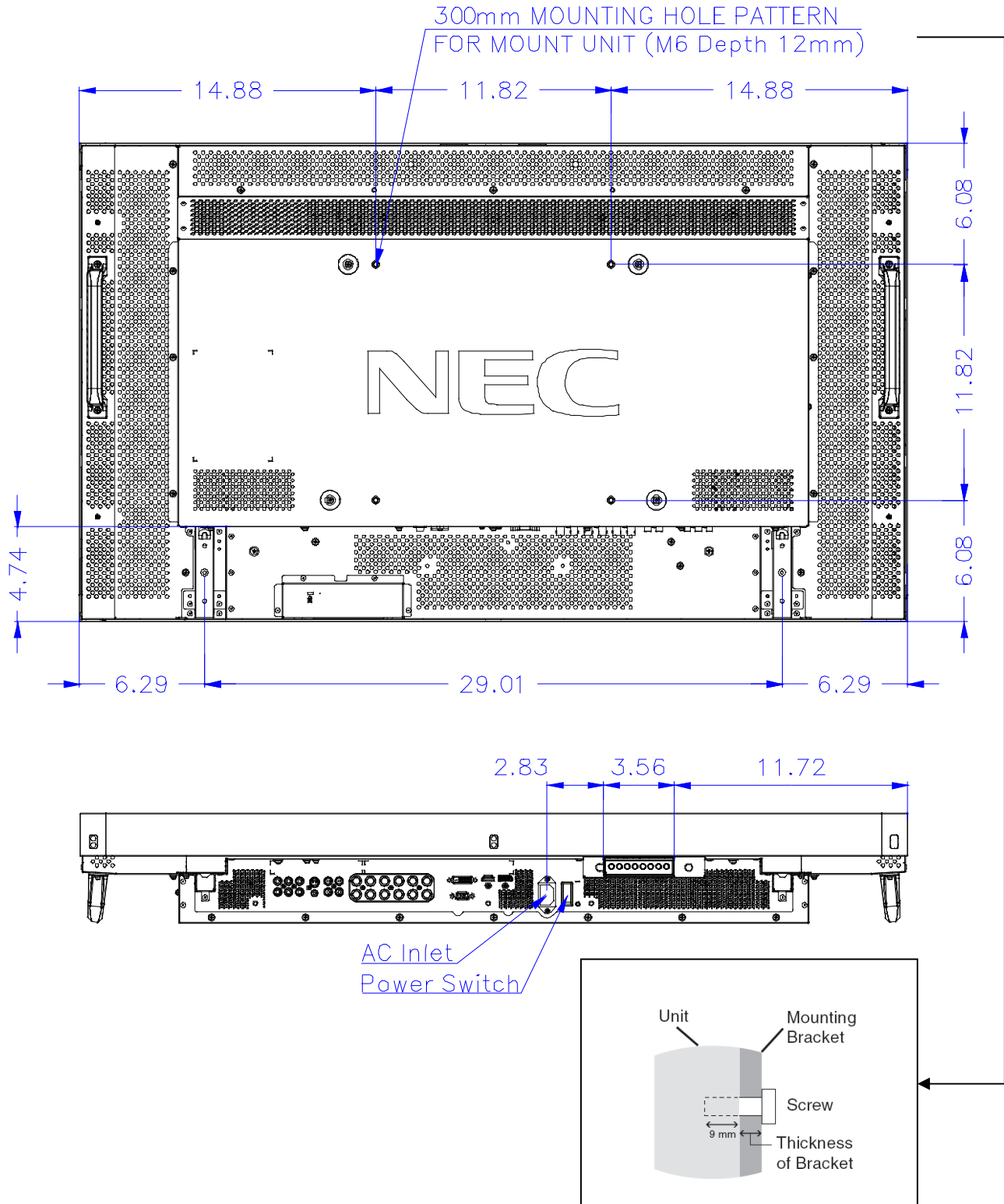

P461 Installation Guide

46" LCD Display

Rev 1.2

Dimensions with optional speakers and stand:

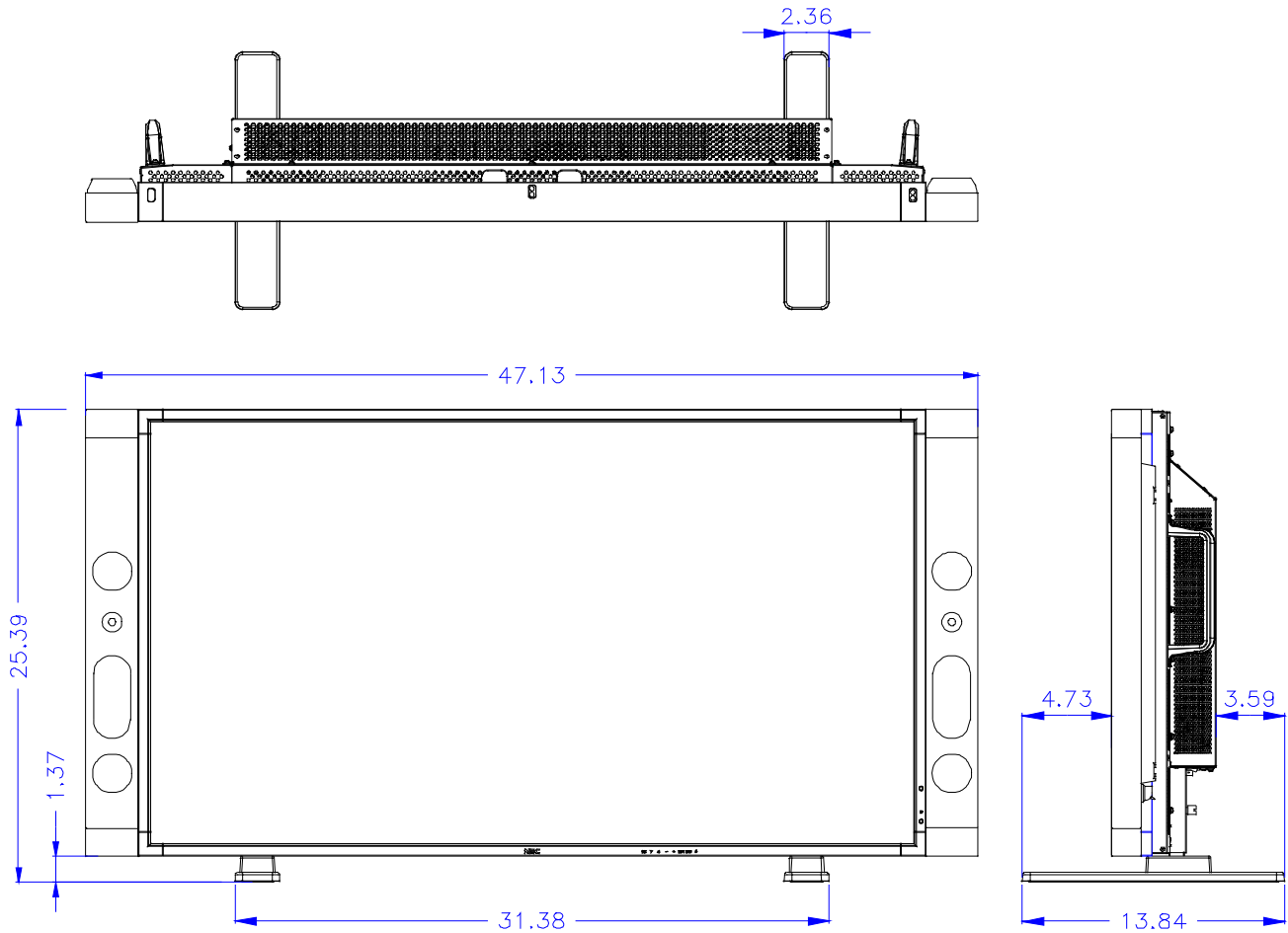

P461 Installation Guide

46" LCD Display

Rev 1.2

Optional Table Top Stand Dimensions (ST-4620):

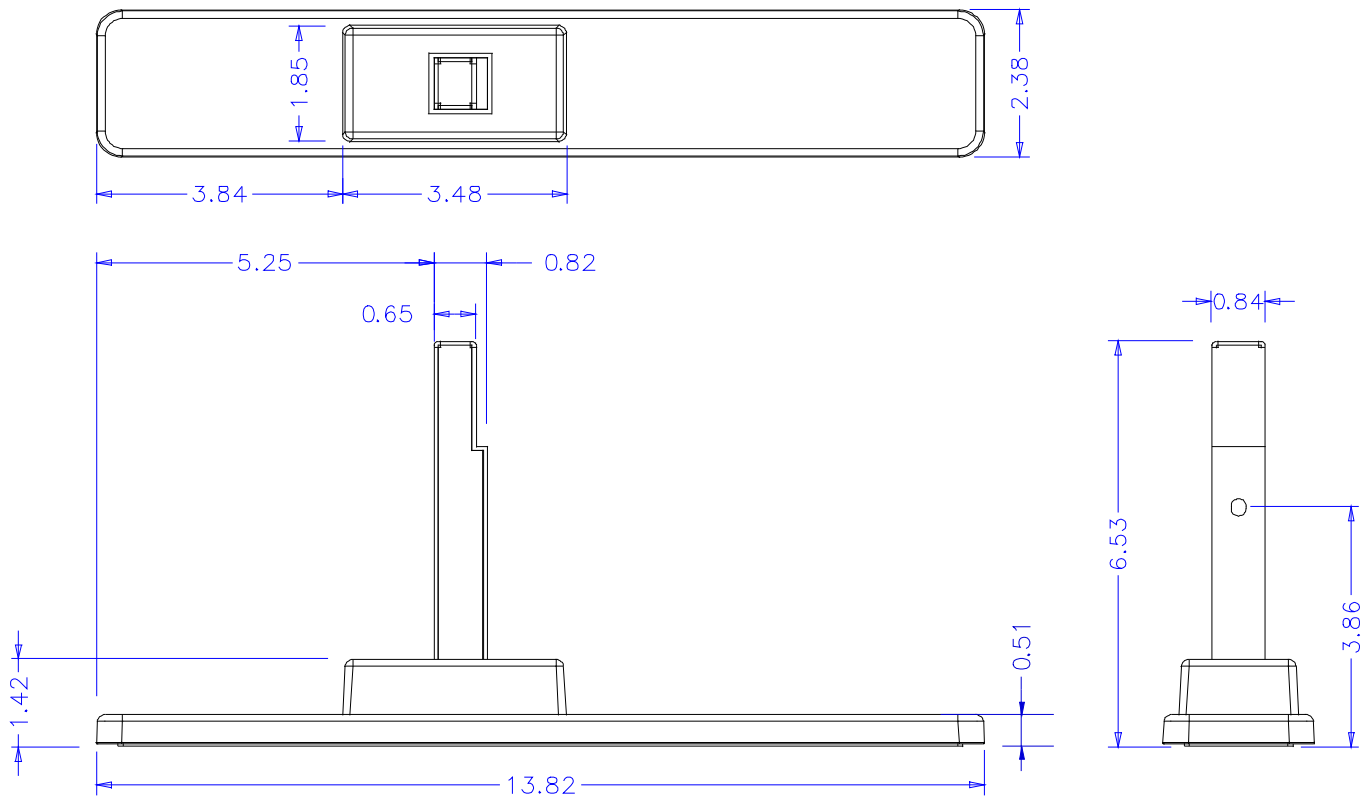

P461 Installation Guide

46" LCD Display

Rev 1.2

Optional Speaker Dimensions (SP-P4046):

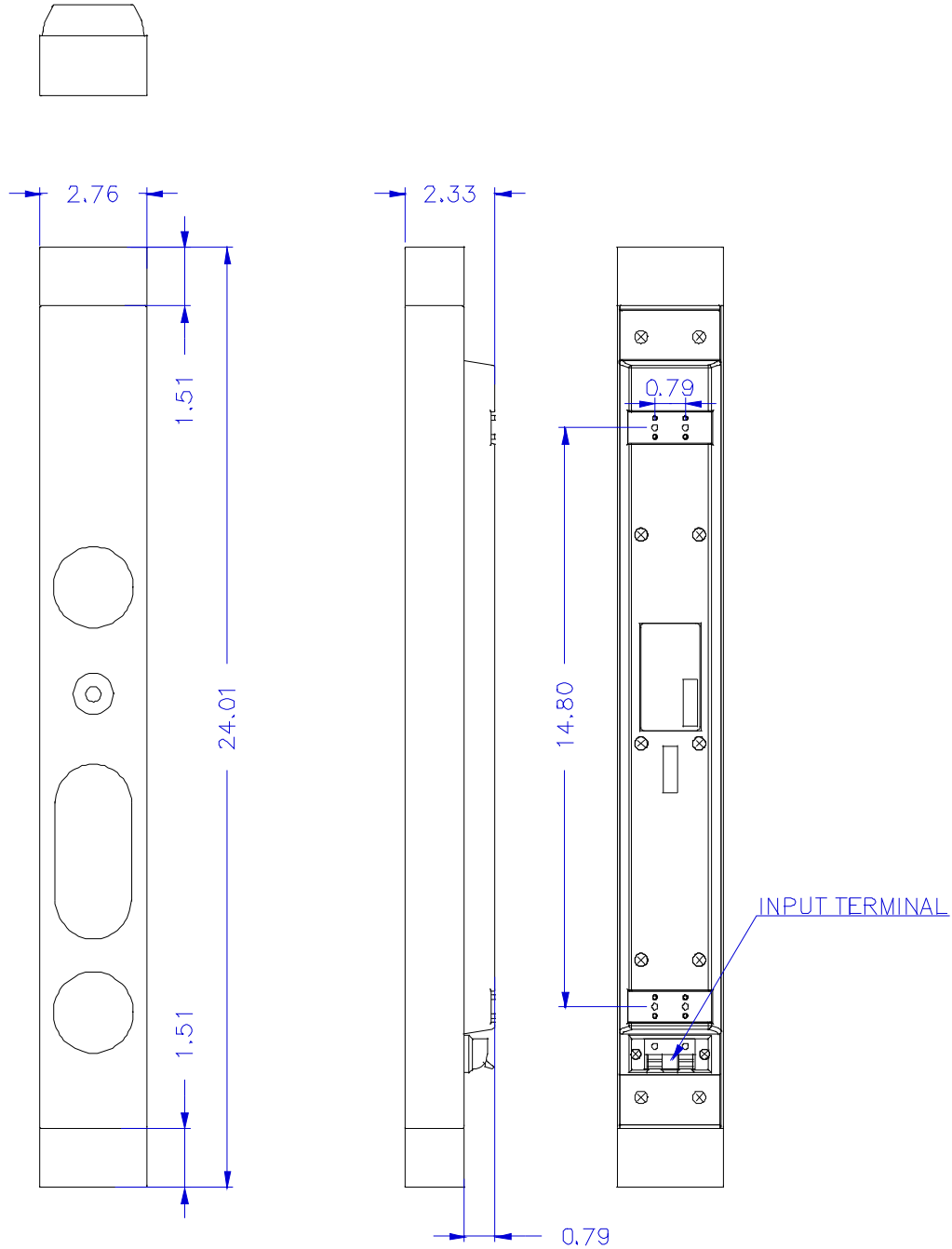

P461 Installation Guide

46" LCD Display

Rev 1.2

Dimensions with Optional Wall Mount Kit (WMK3260-L):

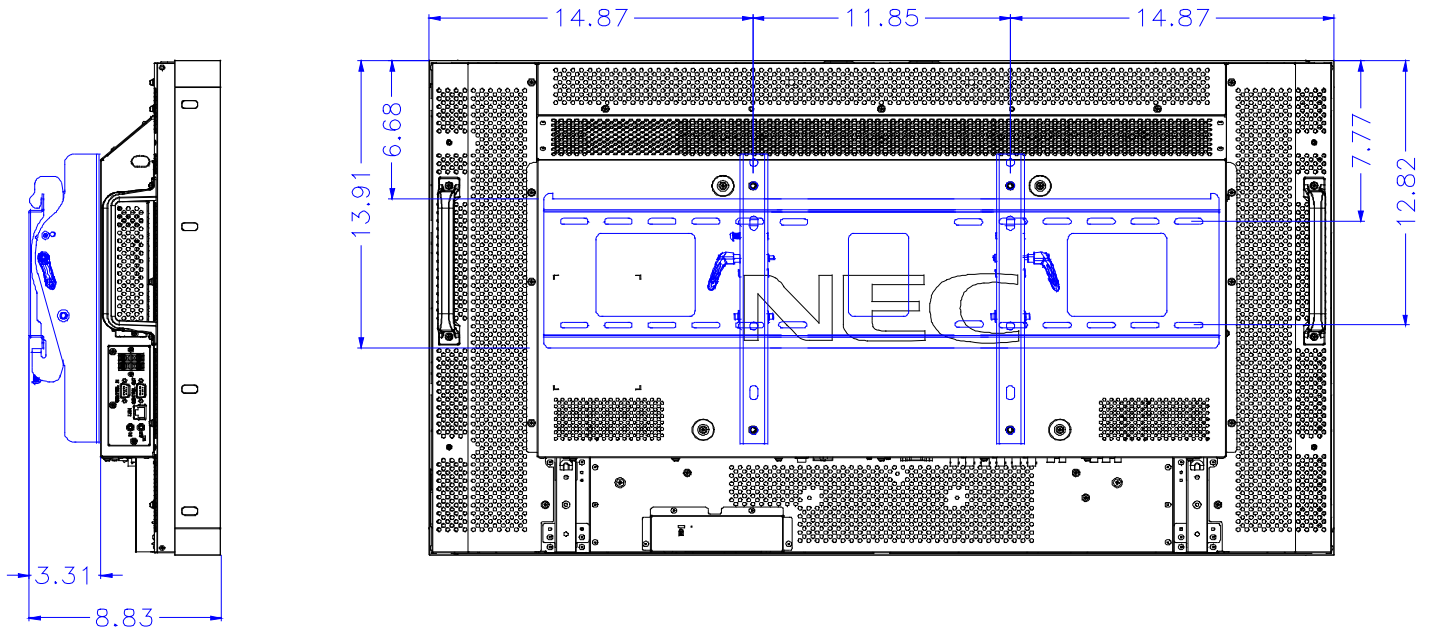

P461 Installation Guide

46" LCD Display

Rev 1.2

Dimensions with Optional Wall Mount Kit (WMK3257):

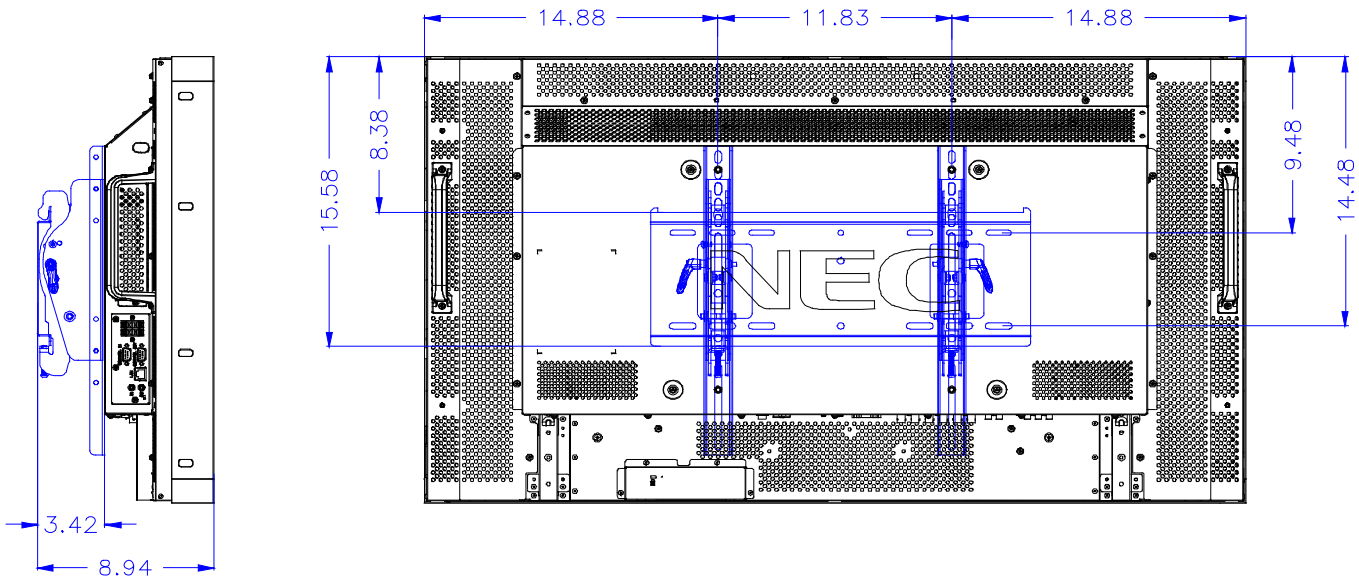

NOTE: Vertical rails on WMK-3257 are shown with 400mm extension rail attached. Extension rails included with mount.

P461 Installation Guide

46" LCD Display

Rev 1.2

Input Panels:

Bottom:

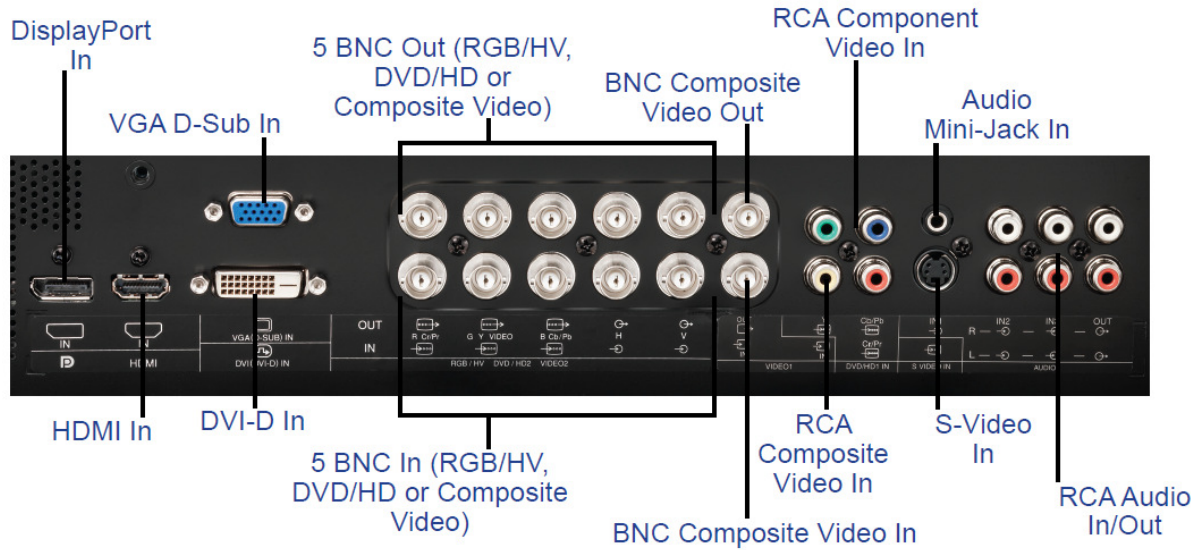

Side:

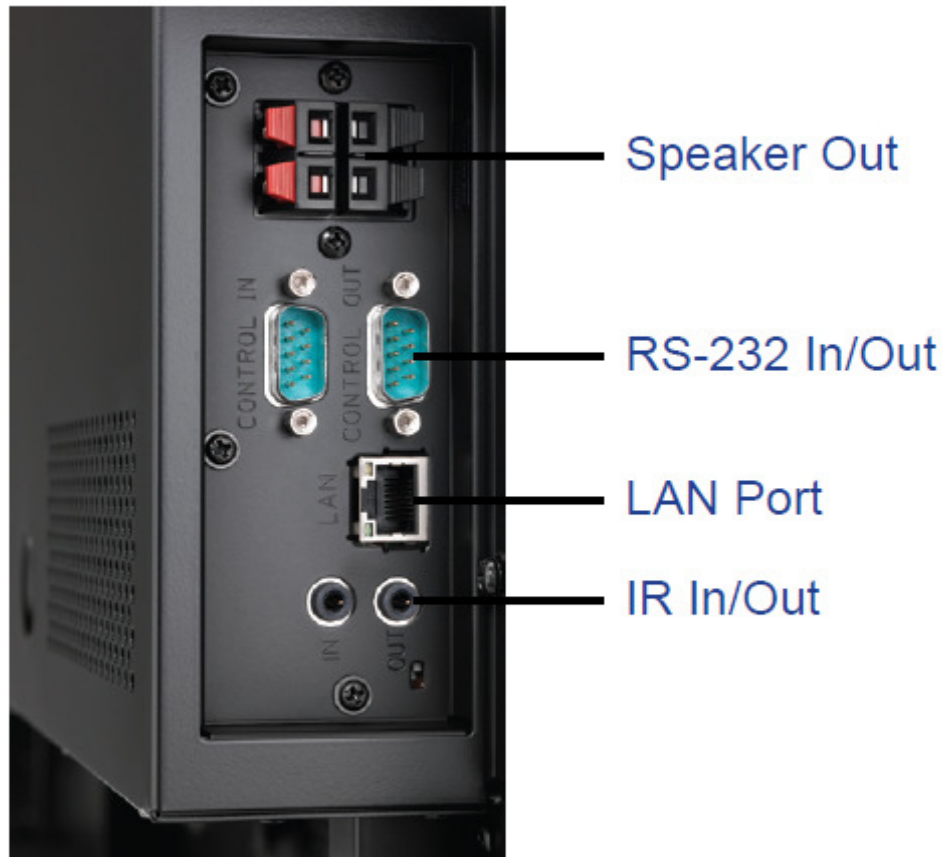

P461 Installation Guide

46" LCD Display

Rev 1.2

Control Codes:

Function		Code Data
POWER	ON	01 30 41 30 41 30 43 02 43 32 30 33 44 36 30 30 30 31 03 73 0D
	OFF	01 30 41 30 41 30 43 02 43 32 30 33 44 36 30 30 30 34 03 76 0D
INPUT SWITCH	VGA (15pin HD)	01 30 41 30 45 30 41 02 30 30 36 30 30 30 30 31 03 73 0D
	RGBHV	01 30 41 30 45 30 41 02 30 30 36 30 30 30 30 32 03 70 0D
	DVI	01 30 41 30 45 30 41 02 30 30 36 30 30 30 30 33 03 71 0D
	HDMI	01 30 41 30 45 30 41 02 30 30 36 30 30 30 30 34 03 76 0D
	VIDEO (Composite)	01 30 41 30 45 30 41 02 30 30 36 30 30 30 30 35 03 77 0D
	DVD/HD	01 30 41 30 45 30 41 02 30 30 36 30 30 30 30 30 43 03 01 0D
	S-Video	01 30 41 30 45 30 41 02 30 30 36 30 30 30 30 37 03 75 0D
	TV (Analog)	01 30 41 30 45 30 41 02 30 30 36 30 30 30 30 39 03 7B 0D
TV (Digital)	01 30 41 30 45 30 41 02 30 30 36 30 30 30 30 41 03 03 0D	
	Option	01 30 41 30 45 30 41 02 30 30 36 30 30 30 30 44 03 06 0D
AUDIO MUTE	ON	01 30 41 30 45 30 41 02 30 30 38 44 30 30 30 31 03 09 0D
	OFF	01 30 41 30 45 30 41 02 30 30 38 44 30 30 30 32 03 0A 0D
PICTURE MODE	sRGB	01 30 41 30 45 30 41 02 30 32 31 41 30 30 30 31 03 07 0D
	HIBRIGHT	01 30 41 30 45 30 41 02 30 32 31 41 30 30 30 33 03 05 0D
	STANDARD	01 30 41 30 45 30 41 02 30 32 31 41 30 30 30 34 03 02 0D
	CINEMA	01 30 41 30 45 30 41 02 30 32 31 41 30 30 30 35 03 03 0D
SCREEN MODE:	NORMAL	01 30 41 30 45 30 41 02 30 32 37 30 30 30 30 31 03 70 0D
	FULL	01 30 41 30 45 30 41 02 30 32 37 30 30 30 30 32 03 73 0D
	WIDE	01 30 41 30 45 30 41 02 30 32 37 30 30 30 30 33 03 72 0D
	ZOOM	01 30 41 30 45 30 41 02 30 32 37 30 30 30 30 34 03 75 0D
AUTO SETUP	EXECUTE	01 30 41 30 45 30 41 02 30 30 31 45 30 30 30 31 03 01 0D
FILM MODE	OFF	01 30 41 30 45 30 41 02 30 30 30 32 30 30 30 31 03 77 0D
	AUTO	01 30 41 30 45 30 41 02 30 30 30 32 30 30 30 32 03 74 0D

NOTE: Contact your NEC rep for codes not listed.

NOTE: Use a cross/reverse/null modem cable.

Cable Connection:

Communication Protocol:

Interface:	RS-232C	Parity:	None
Communication:	Asynchronous	Stop Bit:	1 bit
Baud Rate:	9600 bps	Communication Code:	Hex
Data Length:	8 bits		

PC Control Connector (D-Sub 9P)

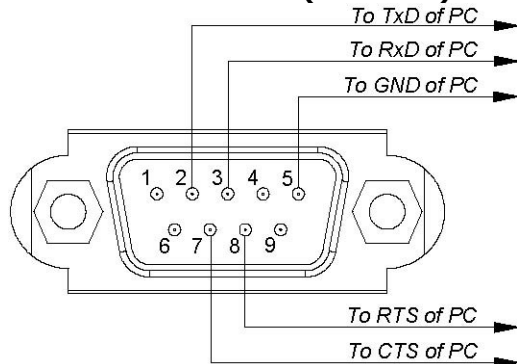

NOTE: If so desired, jumper "Request to send" and "Clear to Send" together on both ends of the cable to simplify cable connection. These connections are not required. The only connections required are pins 2 (TxD), 3 (RxD) and 5 (GND).