

50XM4 Installation Guide

50" Plasma Display

v1.2

Contents

Product Description and Notes	Page 1
Ventilation Requirements	Page 2
Display Dimensions	
Front, Top & Bottom	Page 3
Rear, Left & Right Side	Page 4
Display Dimensions w/Optional Speakers and Stand	Page 5
Dimensions w/Optional Flat Wall Mount	Page 6
Dimensions w/Optional Tilt Wall Mount	Page 7
Dimensions w/Optional Ceiling Mount	Page 8
Portrait Mode	Page 9
Connections	Page 10
Control Codes	Page 11

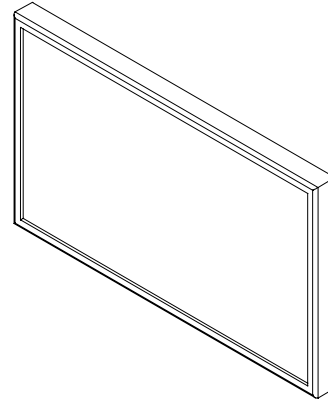

Product Description

Type:	Plasma Display	Screen Surface:	Anti-Reflective
Resolution:	1365x768	Dimensions:	48.1"(W) x 29.0"(H) x 3.8"(D)
Aspect Ratio:	16:9	Weight:	97 lbs
Color Correction:	NEC CCF (Capsulated Color Filter, in panel) and AccuCrimson (in front filter)		

Notes

- This document is intended to be used as a reference guide to supply useful information for a design or installation. It is not intended to be a step-by step procedure for installation.
- Any ceilings or walls must be strong enough to support the display and the installation must be in accordance with any local building codes. All mounts should make secure contact to wood studs.
- 4:3 sources can be displayed on the 16:9 screen in either normal aspect ratio with bars on the left or right, or stretched horizontally to fill the screen using the menus (see "Aspect Modes" in menus and user manual).
- Distances are in inches, for millimeters multiply by 25.4.
- Distances may vary $\pm 5\%$.

Maximum Tilt Angles

Below are the maximum angles that the display can be tilted in both landscape and portrait mode

Landscape	30°
Portrait	10°

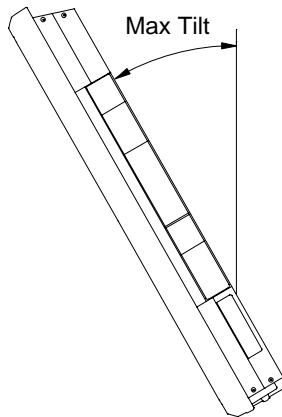

Ventilation Requirements

Dimensions below are minimum required for proper ventilation.

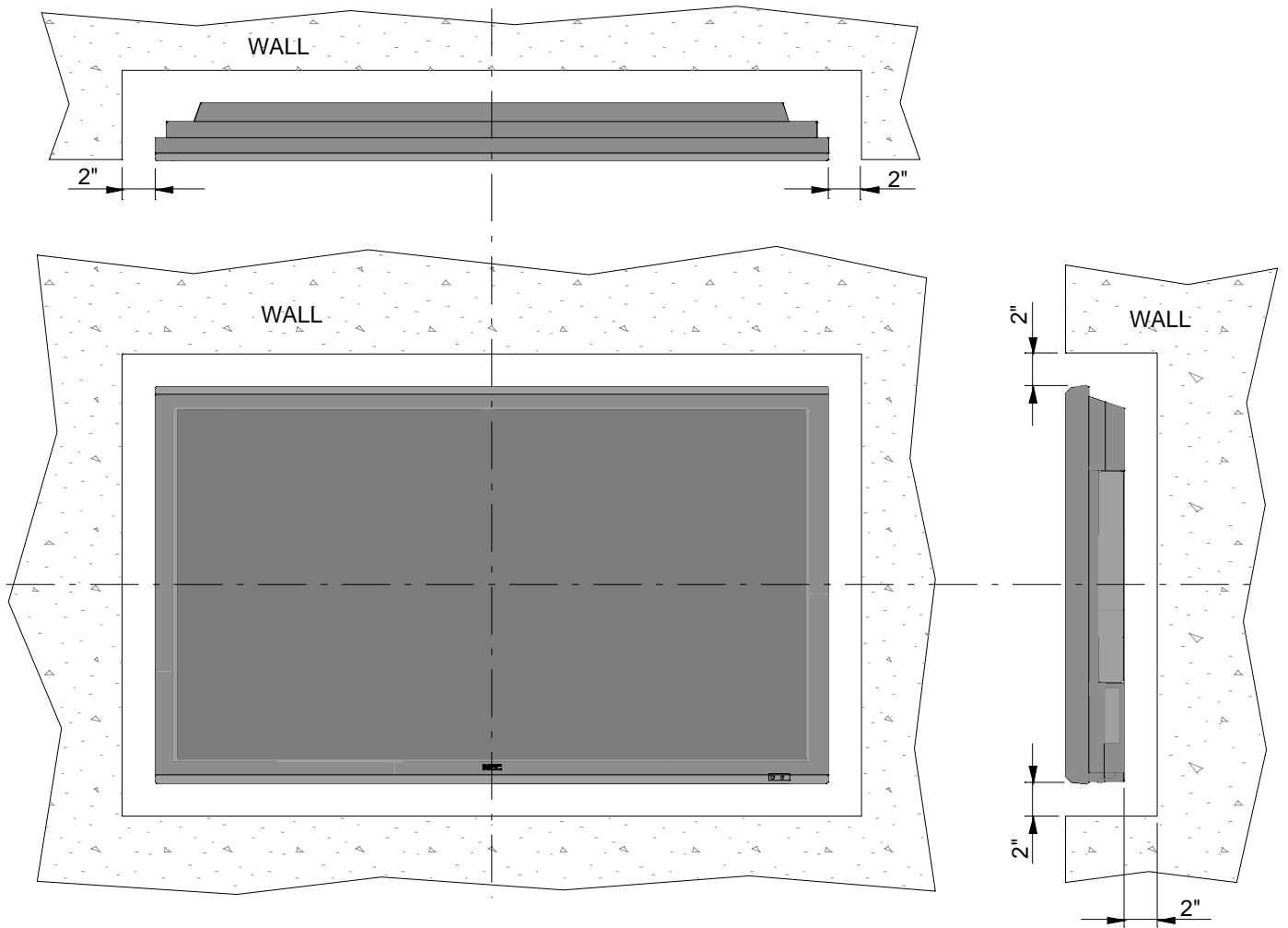

NOTE: The ventilation space should not be covered or closed off at the front of the opening. If for some reason the opening needs to be covered, other means of ventilation will need to be incorporated into the design. Contact NEC for design review and recommendations.

Display dimensions

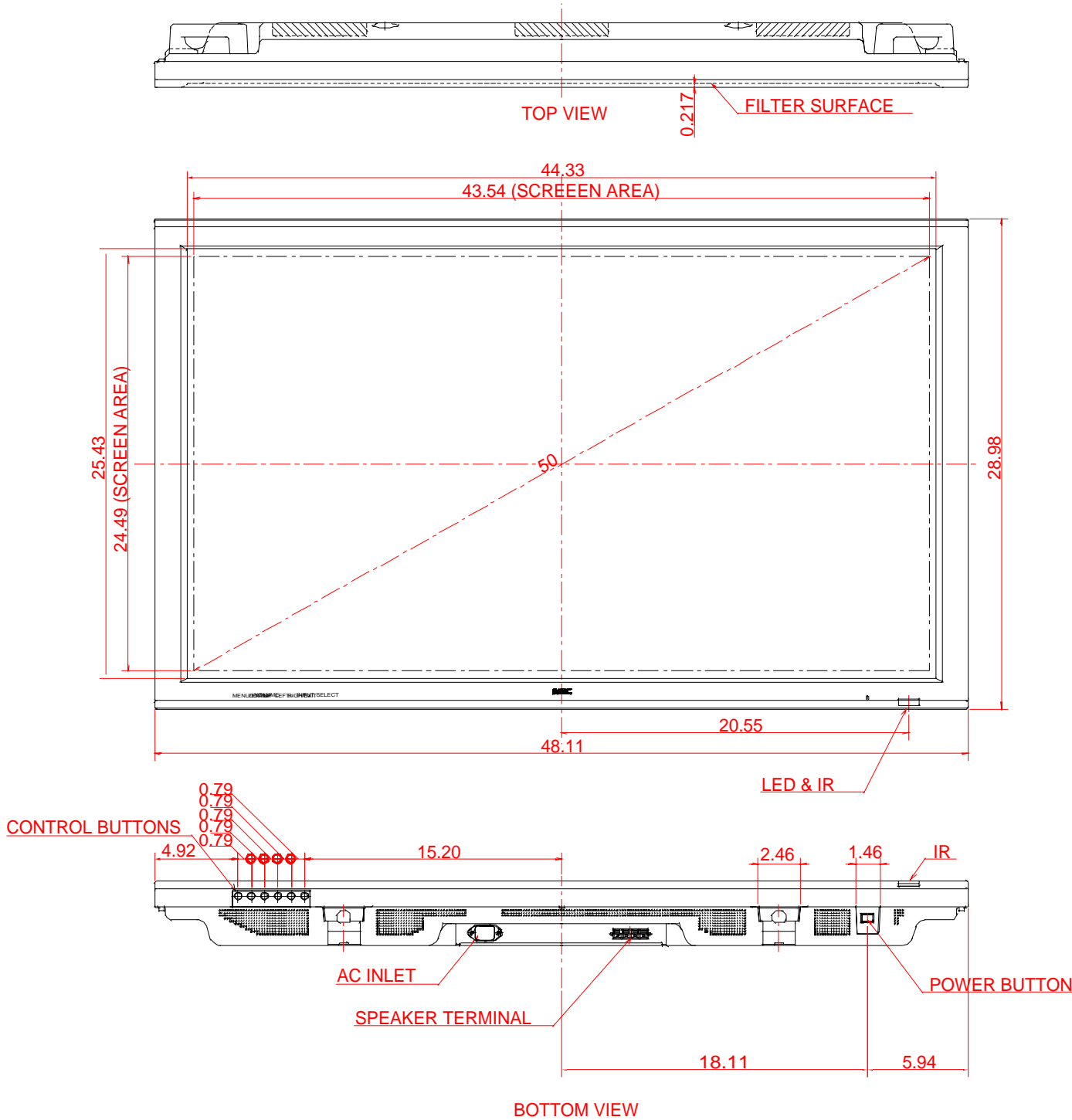

Display dimensions (cont.)

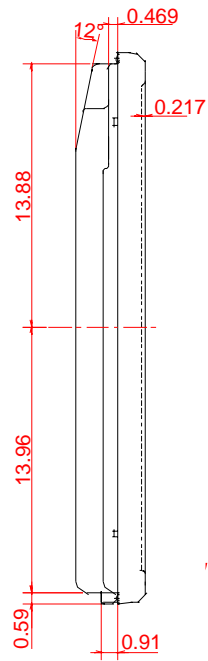
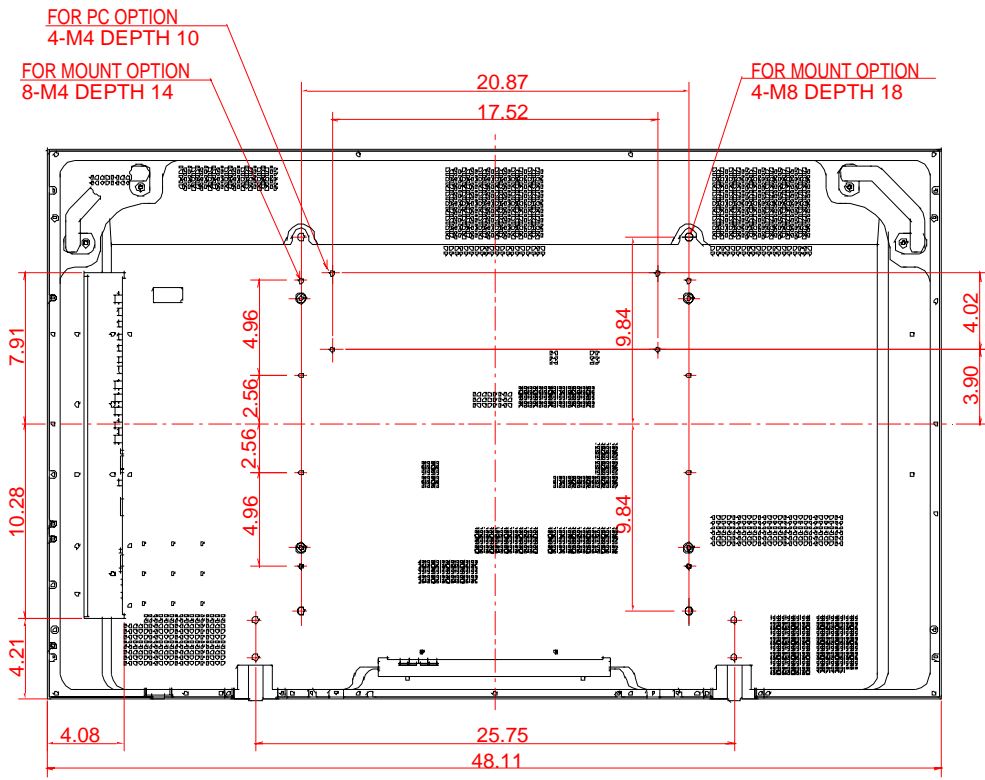

LEFT SIDE VIEW

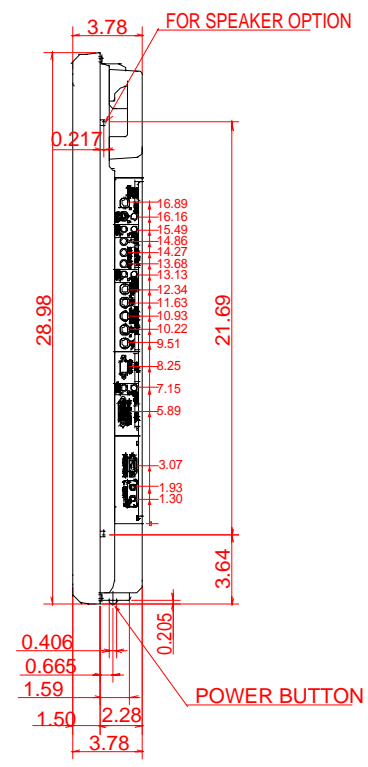

RIGHT SIDE VIEW

Dimensions with optional speakers and stand

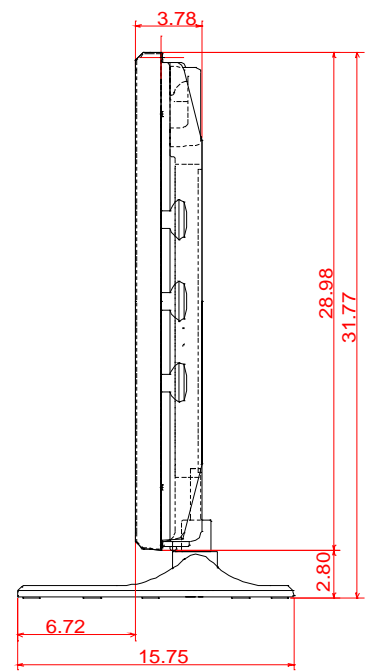
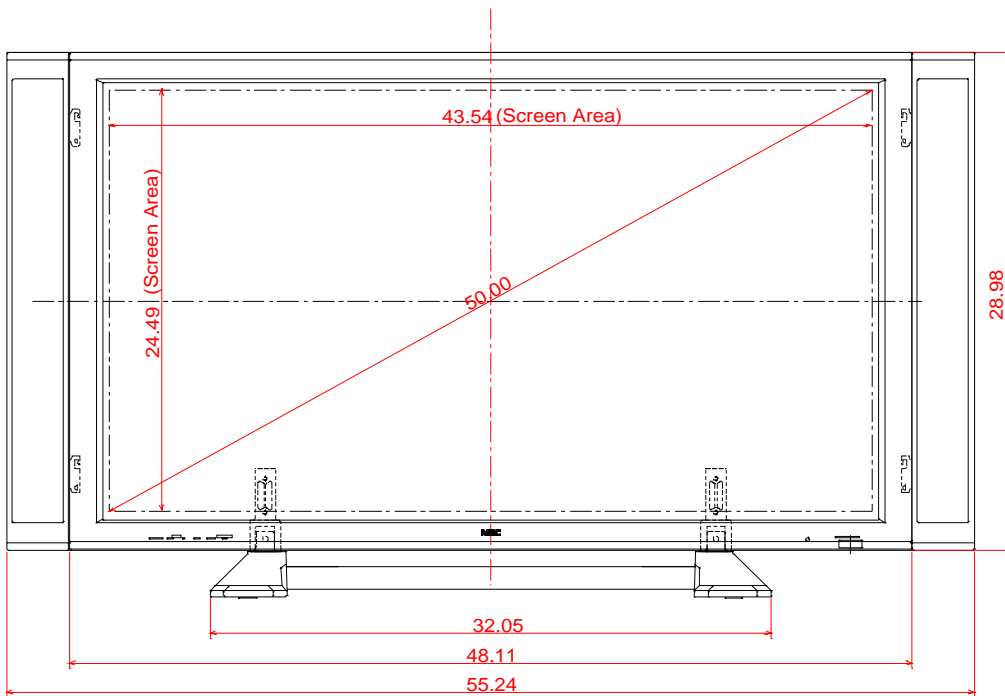
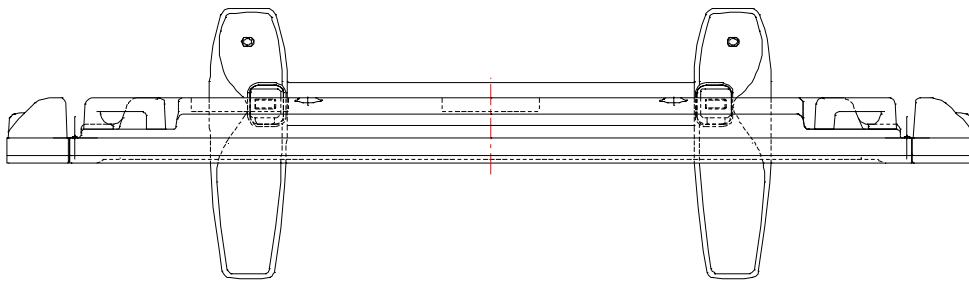

Dimensions with optional Flat Wall Mount Kit (FWMK)

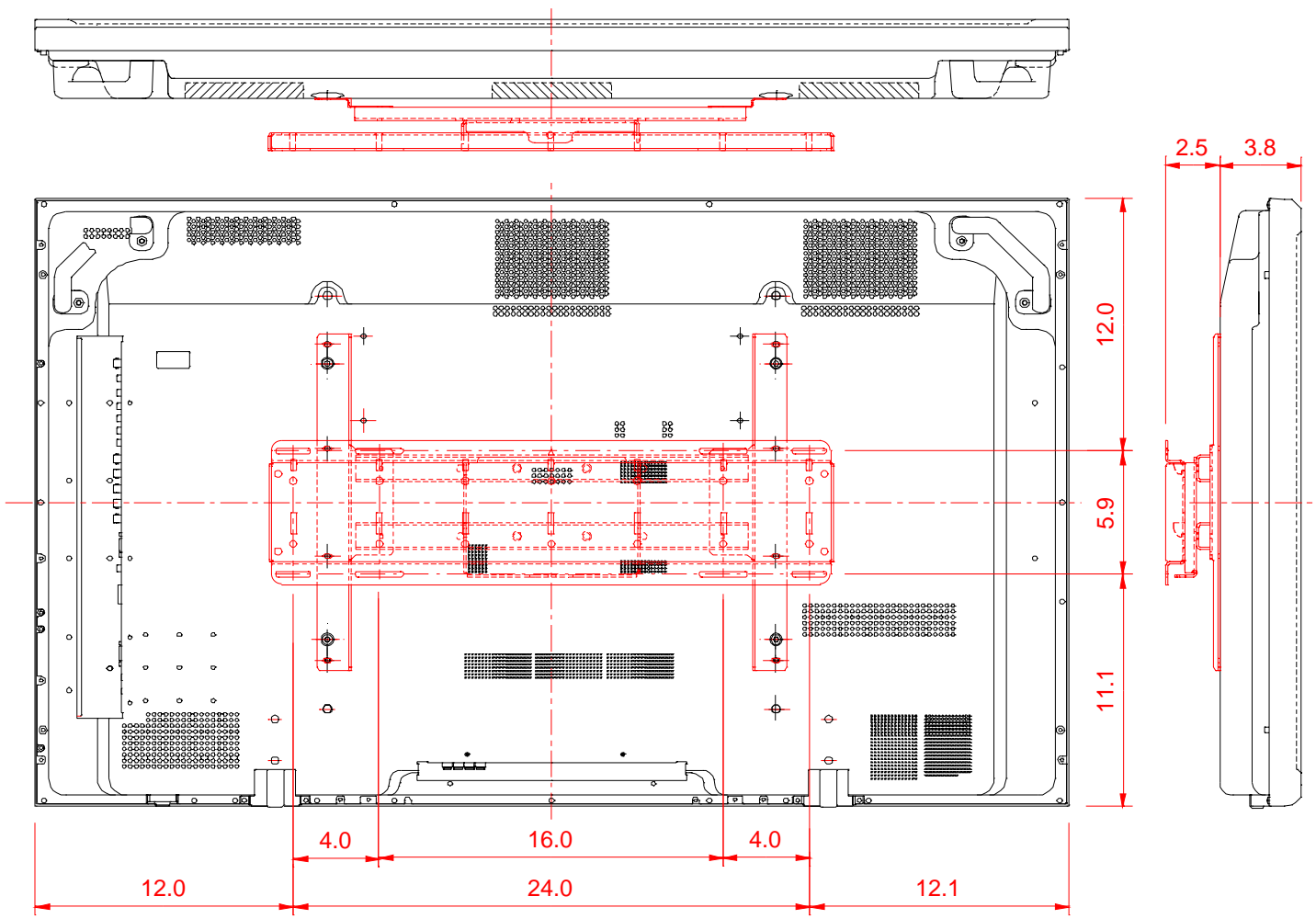

Dimensions with optional Tilt Wall Mount Kit (TWMK)

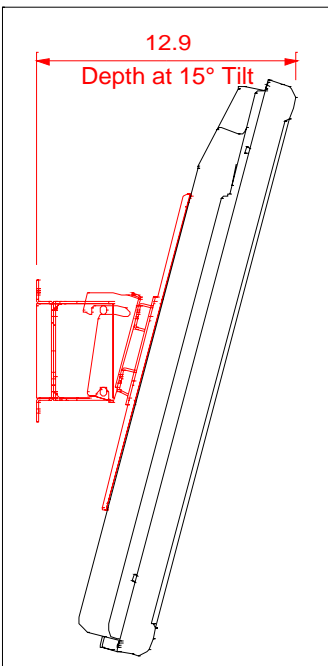
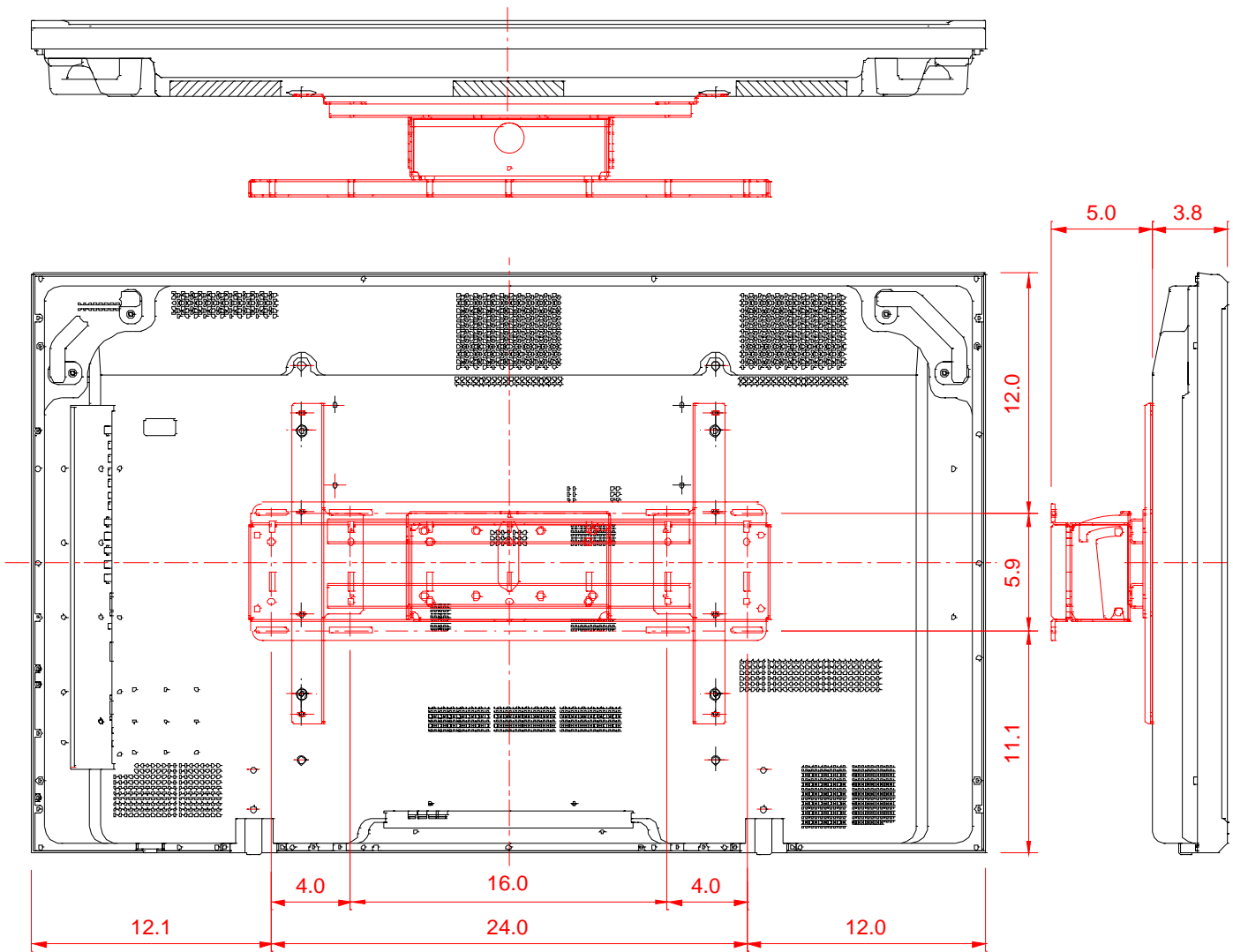

Dimensions with optional Ceiling Mount Kit (CMK)

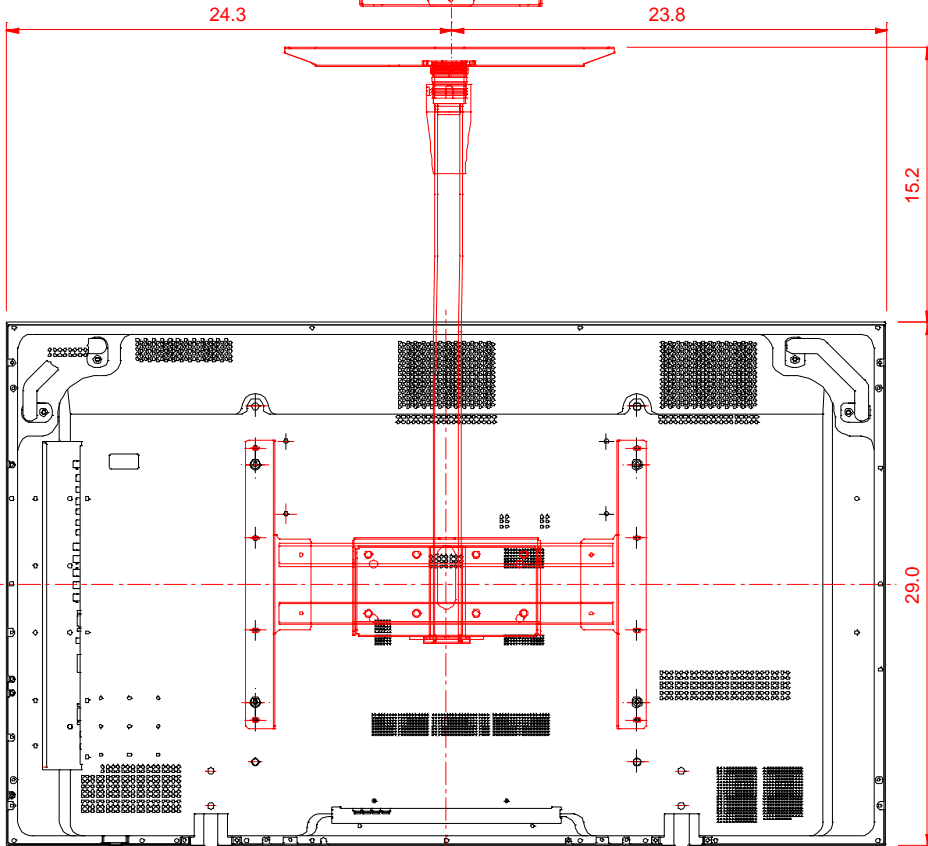
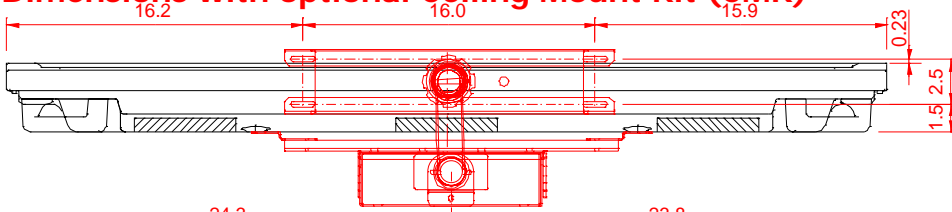

Tilt Range: 0° - 15°

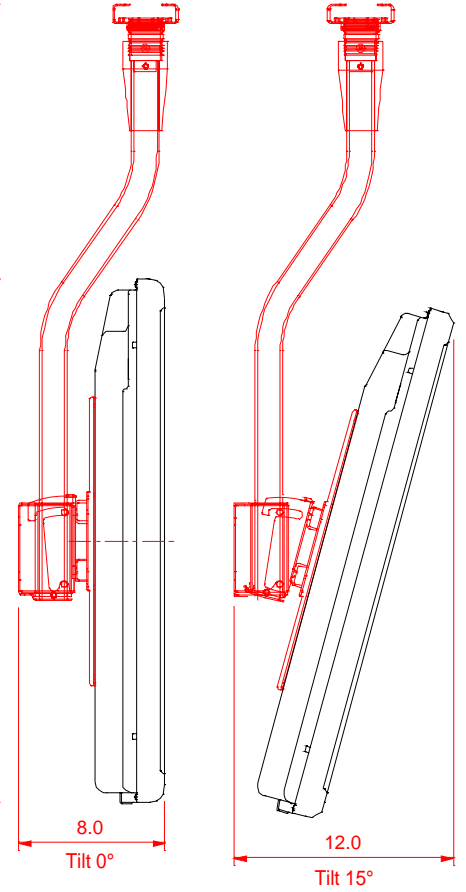

Portrait Mode

Rotating the Display

The display must be rotated clockwise so the input panel is at the bottom and vents are at the top. Rotating the display counter-clockwise will not allow the unit to cool properly and will void the warranty.

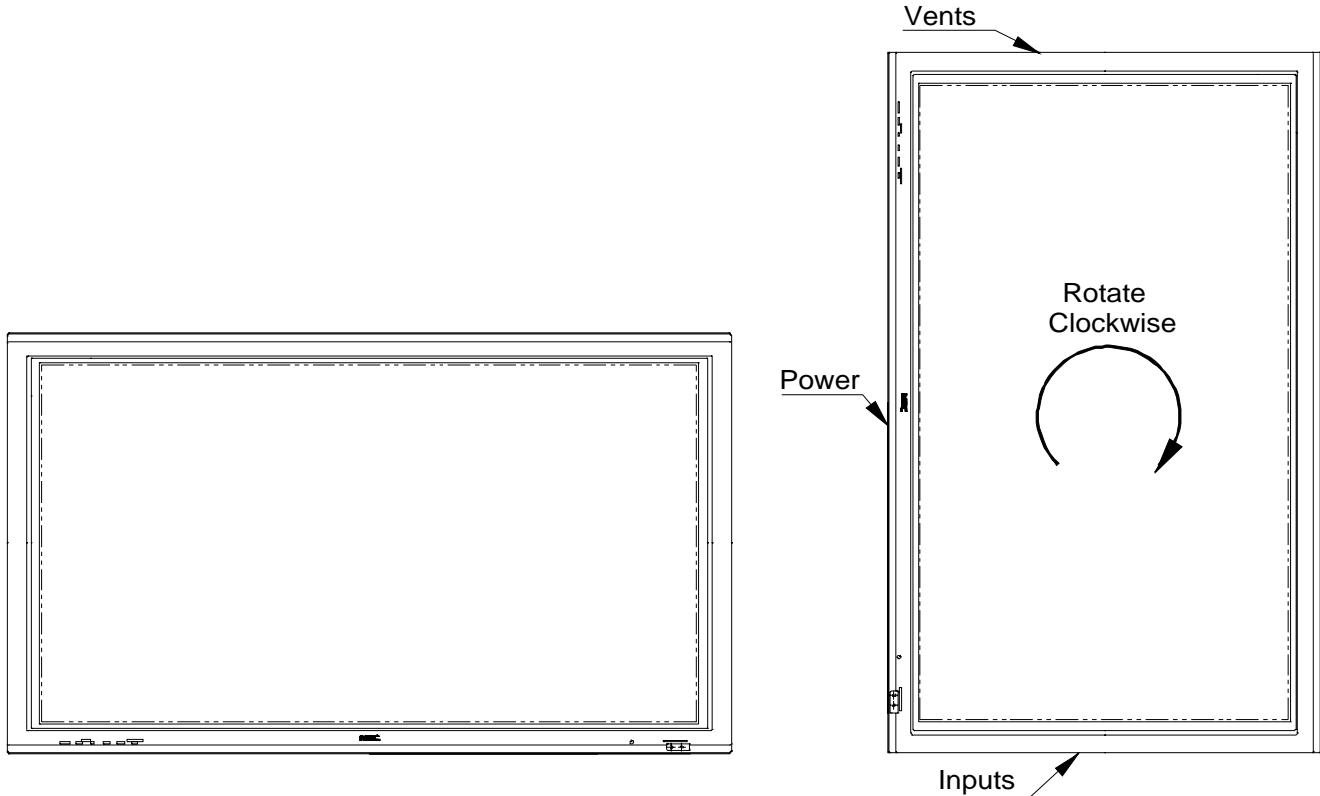

Rotating Source Content

Note: The display is not capable of rotating any source content.

PC

Pivot® software from Portrait Displays, Inc. (www.portrait.com) allows you to rotate the Windows operating system 90 degrees. This software installs in Windows on the PC and allows you to select landscape or rotate 90 degrees to portrait mode. Everything running in the Windows environment is also rotated.

Note: All displays connected to the PC will have to support rotating to portrait mode.

NTSC Video

NTSC Video has to be brought into a PC with the appropriate hardware and software, and sent back out through the PC graphics output. The method to rotate the video would then be the same as above and done within the PC Windows environment.

Connections

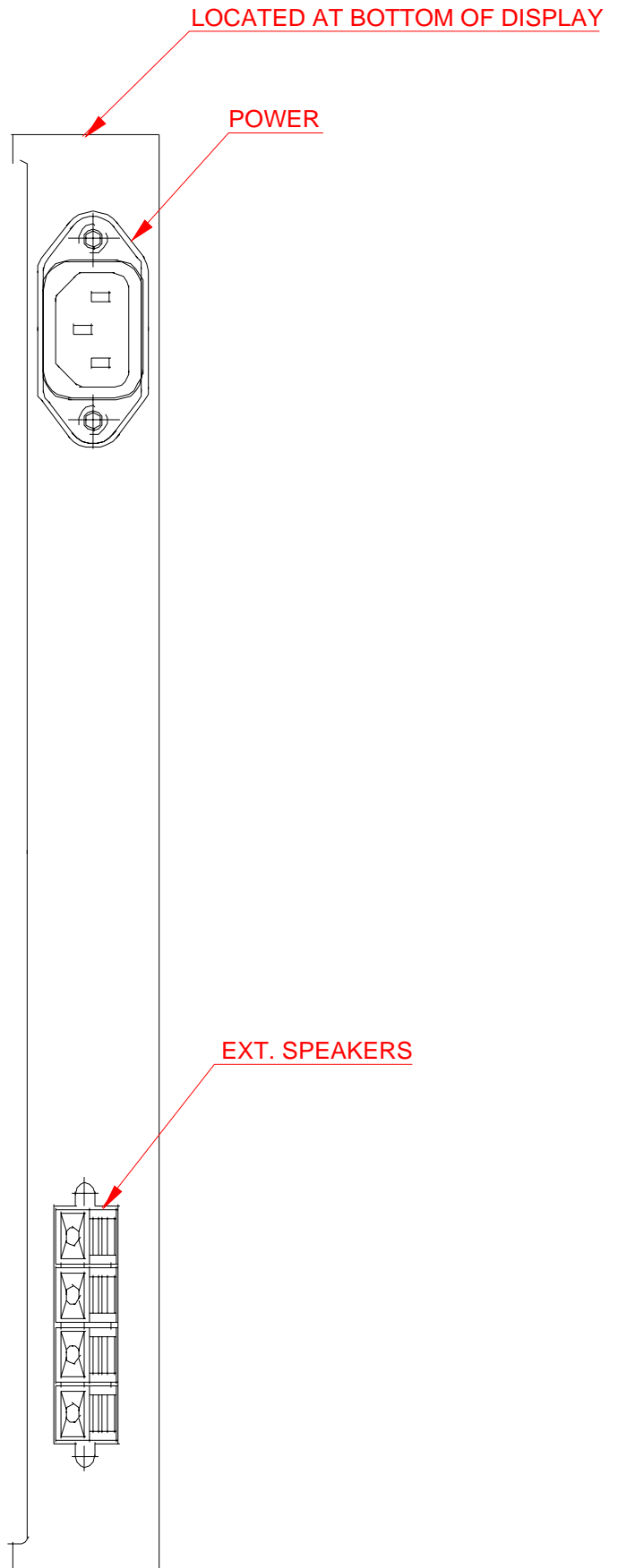
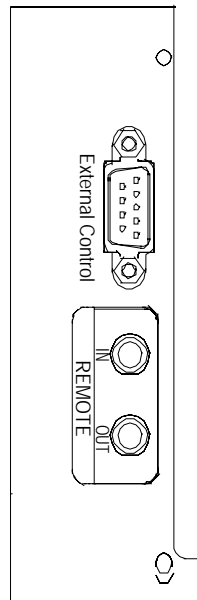
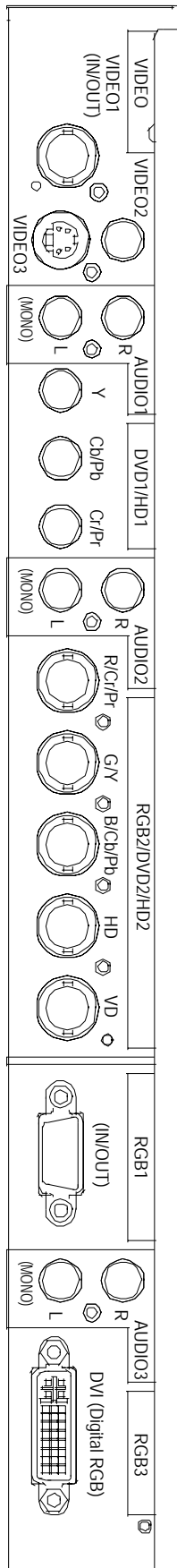

Control Codes

Function		Code Data								
POWER	ON	9FH	80H	60H	4EH	00H	CDH			
	OFF	9FH	80H	60H	4FH	00H	CEH			
INPUT SWITCH	VIDEO1 (BNC)	DFH	80H	60H	47H	01H	01H	08H		
	VIDEO2 (RCA)	DFH	80H	60H	47H	01H	02H	09H		
	VIDEO3 (S-Video)	DFH	80H	60H	47H	01H	03H	0AH		
	DVD1/HD1 (RCA/Component)	DFH	80H	60H	47H	01H	05H	0CH		
	DVD2/HD2 (5BNC/Component)	DFH	80H	60H	47H	01H	06H	0DH		
	RGB1 (15pin HD)	DFH	80H	60H	47H	01H	07H	0EH		
	RGB2 (5BNC/RGB)	DFH	80H	60H	47H	01H	08H	0FH		
	RGB3 (DVI)	DFH	80H	60H	47H	01H	0CH	13H		
AUDIO MUTE	ON	9FH	80H	60H	3EH	00H	BDH			
	OFF	9FH	80H	60H	3FH	00H	BEH			
PICTURE MODE	NORMAL	DFH	80H	60H	0AH	01H	01H	CBH		
	THEAT.1	DFH	80H	60H	0AH	01H	02H	CCH		
	THEAT.2	DFH	80H	60H	0AH	01H	03H	CDH		
	DEFAULT	DFH	80H	60H	0AH	01H	04H	CEH		
SCREEN MODE:	STADIUM	DFH	80H	60H	51H	01H	02H	13H		
	ZOOM	DFH	80H	60H	51H	01H	03H	14H		
	NORMAL	DFH	80H	60H	51H	01H	04H	15H		
	FULL	DFH	80H	60H	51H	01H	05H	16H		
AUTO PICTURE	ON	DFH	80H	60H	7FH	03H	03H	09H	00H	4DH
	OFF	DFH	80H	60H	7FH	03H	03H	09H	01H	4EH
CINEMA MODE	ON	DFH	80H	60H	C1H	01H	01H	82H		
	OFF	DFH	80H	60H	C1H	01H	02H	83H		

NOTE: Contact your NEC rep for codes not listed.

NOTE: Use a cross/reverse/null modem cable.

Cable Connection

Communication Protocol:

Interface:	RS-232C	Parity:	Odd
Communication:	Asynchronous	Stop Bit:	1 bit
Baud Rate:	9600 bps	Communication Code:	Hex
Data Length:	8 bits		

PC Control Connector (D-Sub 9P)

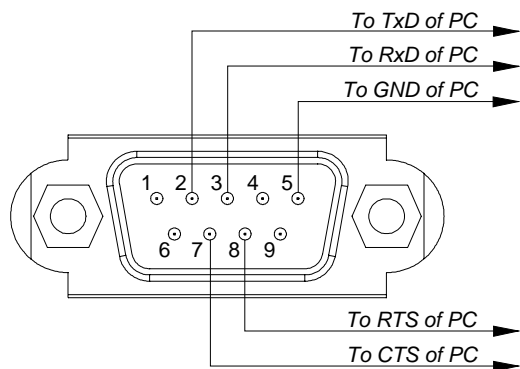

NOTE: Jumper "Request to send" and "Clear to Send" together on both ends of the cable to simplify cable connection.